

FOODSERVICE EQUIPMENT PRICE LIST

DOMESTIC – July 1, 2022





People who serve,
products that solve.®

Direct line equipment
orders and inquiries
(800) 4-HOT-IDEAS
(800) 446-8433

How to Order

To ensure prompt and accurate
processing of your order, please
provide the following information:

1. Model number, voltage, Hertz and phase.
2. Specify options and accessories as required. Options are not retrofittable.
3. Consult factory when ordering equipment for special applications.
4. E-mail orders are acceptable and do not require confirmation.
5. See Resources section in back of book for more information.

**ALL WATT RATINGS ARE
NOMINAL. ACTUAL WATTAGE
MAY VARY. CONSULT FACTORY
FOR MORE INFORMATION.**

E-mail orders to:
equipsales@hatcocorp.com

E-mail inquiries and requests to:
support@hatcocorp.com

Hatco Corporation
P.O. Box 340500
Milwaukee, WI 53234-0500
Telephone: (800) 558-0607
(414) 671-6350
www.hatcocorp.com

Who We Are

Since 1950, Hatco has been a leader in creating innovative ideas for the foodservice industry: bold innovations in equipment that improve efficiency, reliability and profits. Products are designed and built to handle the rugged demands of today's foodservice operations. Hatco is a company dedicated to exceptional customer service and quality engineered equipment offering maximum performance.

We Pride Ourselves On Being Employee Owned

The company was started by Gordon and LaReine Hatch in 1950 and was led by their son, David, beginning in 1990. In 2004, Hatco Corporation began the journey of employee ownership and in 2007, a monumental event in Hatco history occurred: the employees assumed 100% ownership from David Hatch! Hatco still remains a family corporation - only now our family is larger. The employee owners are driven by the spirit of ownership and motivated by the empowerment of ownership.

Equipment

Booster Water Heaters	Display Lights	Hot/Cold Wells	Portable Food Warmers
Built-In Shelves	Drawer Warmers	Hot Food Merchandisers	Refrigerated Wells
Built-In Warmers	Frost Tops	Hot Water Dispensers	Rethermalizers
Carving Stations	Fry Stations	Ice Wells	Rice Drawer Warmers
Cold Shelves	Griddles	Induction	Sanitizing Sink Heaters
Cold Wells	Heated Shelves	Light Cooking Equipment	Snack System
Commercial Toasters	Heated Wells	Locker Systems	Soup Stations
Crepe Makers	Holding & Display Cabinets	Nacho Chip Warmers	Strip Heaters
Decorative Lamps	Hot/Cold Shelves	Pizza Warmers	Waffle Makers

Locations



Milwaukee - Corporate Office
635 South 28th St. | Milwaukee, WI 53215
800-558-0607 | 414-671-6350



Sturgeon Bay - Manufacturing Facility
208 East Deck Street | Sturgeon Bay, WI 54235
920-743-5595



Let's Get Social



Table of Contents

ORDER PICKUP STATIONS & FOOD LOCKERS	2-9
WELLS	10-52
DECORATIVE LAMPS & DISPLAY LIGHTS	53-63
STRIP HEATERS	64-97
FRY STATIONS	98-103
CARVING STATIONS	104-106
PORTABLES	107-120
BUILT-INS	121-141

DRAWER WARMERS	142-147
MERCHANDISERS	148-170
HOLDING & DISPLAY CABINETS	171-190
TOASTERS	191-197
INDUCTION EQUIPMENT	198-209
LIGHT COOKING EQUIPMENT	210-221
WATER HEATING/SPECIALTY EQUIPMENT	222-239

3CS	224
3CS2	225
AWD	223
C	230-231
CDW	146
CHW	17
CLED	63
CSBF, CSBFR, CSBFX	128-129
CSSB, CSSBR, CSSBX	125
CSSBF, CSSBFR, CSSBFX	126-127
CSU, CSUR, CSUX	130-131
CWB, CWB-S	23-25, 29
CWBR, CWBX, CWBR-S, CWBX-S	26-29
DCS	105
DHWBI, DHWBI-S	11-14
DL, DLL, DLH	NEW 54-60
F2G, F2GB	4-5
F2GP, F2GBP	6-7
FDWD-1-MN	183
FDWD	173, 176-177
FR	226
FR2	227
FS2HAC	190
FS3HAC	149-150
FSCD, FSCDH	168
FSD, FSDT	174-177
FSHAC, FSHACH	190
FSHC-5W, -7W	185
FSHC-6W	186
FSHC-7	187
FSHC-12W, -17W	188-189
FST-1-MN	183
FTB, FTB-S	30-31
FTBR, FTBR-S, FTBX, FTBX-S	32-33
FWM	218
GR2A, GR2AH	86, 88
GR2A-xxD, GR2AH-xxD	89-90
GR2AL, GR2AHL	87-88
GR2AL-xxD, GR2AHL-xxD	89-90
GR2BW	119-120
GR2S	114
GR2SDH, GR2SDS	157-158
GR3SDH, GR3SDS	162-163
GR3SDS-xxDCT, GR3SDS-xxTCT	164
GR5A, GR5AH	67, 69
GR5AL, GR5AHL	68-69
GR, GRH	71-72
GR-B	99
GRA, GRAH	70, 72
GRA-xxD, GRAH-xxD	73, 75

GRAL, GRAHL	71-72
GRAL-xxD, GRAHL-xxD	74-75
GRAIH, GRAIHL	83, 85
GRAIH-xxD, GRAIHL-xxD	84-85
GRAM, GRAML	76-77
GRAM-xxD	78, 80
GRAML-xxD	79-80
GRBW	119-120
GRCB, GRCBH	166-167
GRCMW	165
GRCSCB, GRCSCBH	106
GRFF, GRFFL, GRFFB, GRFFBL	99-100
GRFHS	101-102
GRFS	101-102
GRHD, GRHDH	169-170
GRHW	118
GRN, GRNH	81
GRNM	82
GRPWS	152-153
GRS2G	8
GRS	112-114
GRSB	139-140
GRSBF	141
GRSDH, GRSDS	155-156
GRSDS/H	154
GRSR	109
GRSS	115
GRSSB	137
GRSSR, GRSSRxx-DL77516	110-111
HGB	116
HGBB	138
HCSBF, HCSBFR, HCSBFX	135-136
HCSSB, HCSSBR, HCSSBX	132
HCSBFB, HCSBFR, HCSBFBX	133-134
HCWBI, HCWBIR, HCWBIX	18-19
HDW	144-145
HDWTC	143
HDW-xR2	144-145
HGSM	117
HL	62
HL5	61
HRDW	147
HSBF-GL, -HC, -SS	122-124
HW	17
HWB, HWBL	43-45, 51-52
HWB-xxQT, HWBI-xxQT	46-47, 51-52
HWBI, HWBLI	34-36, 40
HWBI43	37, 40
HWBI-S	38-40
HWBRN, HWBRN (UR)	48-49, 51-52

HWBRT, HWBRT (UR)	48-49, 51-52
HWBRN-xxQT (UR)	50, 51-52
HWBRT-xxQT (UR)	50, 51-52
HXMH, HXMS	159, 161
HZMH, HZMS	160-161
IHDCH	178-179
IRNG-BXC1	199
IRNG-HC1, -PC1, -PB1	200-204
IRNG-PC2F, -PC2S, -PB2	205-206
IWRM-C1, -CD1, -B1	207-208
IWRM-UT	209
IWB, IWB-S	20-22
ITQ	192
KCME	211
KCMG	212
KGRDE	216
KGRDG	216
KSW	215
KWM09, KWM18	213-214
KWMSL	213
LFST	181
LW	108
MC	229
MCG	217
MDW	182
MPP	3
MPWS	103
PDH	151
PFST	184
PMG	228
PSH	151
PWB, PWC	172
RHW	15
RMB	97
RMB2	96
RWM	220
S	232-233
SAL	221
SNACK	219
SW2	16
TK	197
TPT	193
TQ	195-196
TQ3	194
UGA, UGAH	91, 93
UGA-xxD, UGAH-xxD	92-93
UGAL, UGAHL	91, 93
UGAL-xxD, UGAHL-xxD	92-93
UGFF, UGFFL, UGFFB, UGFFBL	99-100
WFST	180

Order Pickup Stations & Food Lockers

*Restaurants • Cafés • Concessions
Cafeterias • Convenience Stores*



MPP-81 pg. 3



F2G-34-A in optional *Designer Navy Blue*
(Customer side shown) pg. 4



F2GB-22-A in standard *Designer Warm Red*
(Operator side shown) pg. 5



F2GP-14-C in standard *Designer Warm Red*
(Customer side shown) pg. 6



GRS2G-3920-5 with optional side and back
panels shown and **GRS2G-3920-2** pg. 8

Pickup Pod™

Hatco's Pickup Pod™, propelled by Minnow™, helps automate customer and delivery pickups. A self-service, touchless pickup solution that reduces lobby/dining area congestion, eliminates pickup mistakes, reduces labor costs, and improves the takeout experience for all. Customers and delivery people simply access their reserved cubbies by scanning the QR code or using the embedded link sent via SMS. All without waiting in line or needing to ask for help from front of house staff. And unlike unsecure tables, The Hatco Pickup Pod keeps food fresh and secure until it's ready to be picked up.

- Pickup Pod offers customers and delivery workers a touchless experience via their own devices with QR code and SMS messaging.
- Touchless interface prevents spreading of germs
- Energy-saving 5000K LED cubby lighting showcases food
- Ambient, individually insulated cubbies
- Configurable pick-up times help ensure food safety
- Antimicrobial surfaces inhibit the growth of bacteria mold and mildew
- Each cubby is a spacious 13¾" W x 14½" D x 15" H
- Plugs into a standard 120V outlet
- Includes wall mounting bracket to keep unit stable
- Connects via Cellular, WiFi, or CAT-5/6
- ADA compliant
- Customer notification sent via SMS Messaging or other methods via POS or App integrations (by others)
- Lily Pad base available to help stabilize units that cannot be fastened to the wall. Can be used in lieu of wall mounting brackets^



MPP-8I
Hatco Pickup Pod in standard Charcoal

NOTE: SaaS (software as a service) fees are required for each unit. Contact factory for subscription fee options.

SaaS fees enables cloud connectivity, user interface and data analytics.

Locker Leasing information now available.
See website for more details

MINNOW PICKUP POD

Model	Number of Lockers	Model Dimensions W x D x H	Internal Locker Dimensions (W x D x H)	Voltage	Watts	Amps	Plug	Ship Weight*	List Price
MPP-8I	8 Lockers	317/8" x 16" x 77¾"	13¾" x 14½" x 15"	120	90	.75	NEMA 5-15P	350 lbs.	\$11550

* Shipping weight includes packaging.
Cord Location: Center, back of unit.

OPTIONS (available at time of purchase only)

Designer Colors – Non-standard colors are non-returnable – Charcoal standard –
BRONZE Bronze

No Charge

ACCESSORIES (available for purchase at any time)

MPP-PAD2-57^	(Charcoal Color) 37.5" H x 25.5" W Lily Pad to stabilize free-standing units. Can only be used in lieu of wall mounting hardware.	\$441
MPP-PAD2-58^	(Bronze Color) 37.5" H x 25.5" W Lily Pad to stabilize free-standing units. Can only be used in lieu of wall mounting hardware.	441

COLORS AND FINISHES – INSIDE BACK COVER

MPP-8I Shown with accessory MPP-PAD2-57^

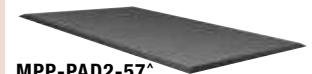

MPP-PAD2-57^

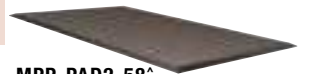

MPP-PAD2-58^

^ Not UL approved component. In order to satisfy UL safety standards, the MPP-8I must be secured to a wall. The Lily pad may be used for stabilization in a freestanding installation, however, it will not satisfy the UL standard for safety in lieu of securing it to a wall. Please contact us if you have any questions.

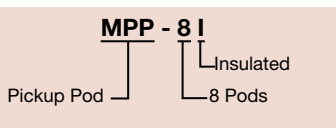



July 1, 2022

Flav-R 2-Go® Locker System

The Hatco F2G Flav-R 2-Go® Countertop, Floor Mount, and Built-In Locker System conveniently holds multiple hot or ambient to-go food orders with quick and secure access. Customers and delivery drivers can arrive, access their specific locker and leave without waiting in line or disturbing the flow of business.

- Large 10" touchscreen for easy viewing (front and/or back)
- Lockers come preset to 150°F with a high temperature range up to 180°F
- Individual lockers can have the heat turned off for ambient storage
- Available in two locker depth sizes
- Available with pass-through or one-sided access (countertop or floor models only)
- Each locker has a timer that will hold prepared and packaged food for up to 45 minutes
- Customer side stays locked. When the access code is used, the door unlocks and LED lights flash in the appropriate locker

Locker Leasing information now available. See website for more details



F2G-3-A
in optional *Designer Black*
(Customer side shown)



F2G-24-A
in standard *Designer Warm Red*
(Operator side shown)

NOTE: This unit is intended for stationary indoor, commercial use only—NOT for mobile applications.

COUNTERTOP AND FLOOR MOUNT LOCKER SYSTEM

Model	Number of Lockers	Model Dimensions W x D x H	Internal Locker Dimensions (W x D x H)	Voltage	Watts	Amps	Plug	List Price
Countertop								
F2G-22-A	4 Lockers	43 ¹ / ₈ " x 14 ³ / ₄ " x 31 ³ / ₄ "	12" x 12" x 12"	120	423	3.8	NEMA 5-15P	\$16547
F2G-22-C	4 Lockers	43 ¹ / ₈ " x 23 ¹ / ₄ " x 31 ³ / ₄ "	12" x 20 ¹ / ₂ " x 12"	120	551	4.8	NEMA 5-15P	16724
F2G-3-A	3 Lockers	61" x 14 ³ / ₄ " x 16 ⁷ / ₈ "	12" x 12" x 12"	120	321	2.9	NEMA 5-15P	13731
F2G-3-C	3 Lockers	61" x 23 ¹ / ₄ " x 16 ⁷ / ₈ "	12" x 20 ¹ / ₂ " x 12"	120	417	3.7	NEMA 5-15P	14166
F2G-32-A	6 Lockers	61" x 14 ³ / ₄ " x 31 ³ / ₄ "	12" x 12" x 12"	120	627	5.5	NEMA 5-15P	20866
F2G-32-C	6 Lockers	61" x 23 ¹ / ₄ " x 31 ³ / ₄ "	12" x 20 ¹ / ₂ " x 12"	120	819	7.1	NEMA 5-15P	21680
Floor Mount								
F2G-24-A	8 Lockers	45 ³ / ₈ " x 14 ³ / ₈ " x 71 ¹ / ₄ "	12" x 12" x 12"	120	831	7.3	NEMA 5-15P	\$26419
F2G-24-C	8 Lockers	45 ³ / ₈ " x 22 ⁷ / ₈ " x 71 ¹ / ₄ "	12" x 20 ¹ / ₂ " x 12"	120	1087	9.4	NEMA 5-15P	28555
F2G-34-A	12 Lockers	62 ¹ / ₄ " x 14 ³ / ₈ " x 71 ¹ / ₄ "	12" x 12" x 12"	120	1239	10.8	NEMA 5-15P	36216
F2G-34-C	12 Lockers	62 ¹ / ₄ " x 22 ⁷ / ₈ " x 71 ¹ / ₄ "	12" x 20 ¹ / ₂ " x 12"	120	1623	14.0	NEMA 5-15P [▲]	38328

▲ Canadian models use NEMA 5-20P.

All Locker System Models Feature:

Cord Location: Countertop Models: Operator side, bottom left.

Floor Models: Facing operator side, left side of unit bottom corner closest to operator side.

OPTIONS AND ACCESSORIES – PAGE 5

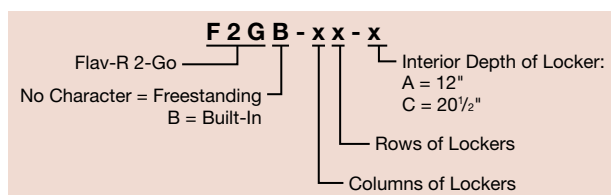

Flav-R 2-Go Locker System continued



F2GB-22-A
in standard *Designer Warm Red* (Operator side shown)



F2GB-22-A
in optional *Designer Black* (Customer side shown)

BUILT-IN LOCKER SYSTEM

Model	Number of Lockers	Model Dimensions W x D x H	Internal Locker Dimensions (W x D x H)	Voltage	Watts	Amps	Plug	List Price
Built-In								
F2GB-22-A	4 Lockers	41 1/4" x 14 3/4" x 34 3/4"	12" x 12" x 12"	120	423	3.8	NEMA 5-15P	\$16607
F2GB-22-C	4 Lockers	41 1/4" x 23 1/4" x 34 3/4"	12" x 20 1/2" x 12"	120	551	4.8	NEMA 5-15P	17334
F2GB-23-A	6 Lockers	41 1/4" x 14 3/8" x 49 5/8"	12" x 12" x 12"	120	627	5.5	NEMA 5-15P	21493
F2GB-23-C	6 Lockers	41 1/4" x 22 7/8" x 49 5/8"	12" x 20 1/2" x 12"	120	819	7.1	NEMA 5-15P	22244
F2GB-3-A	3 Lockers	61" x 14 3/4" x 20"	12" x 12" x 12"	120	321	2.9	NEMA 5-15P	14454
F2GB-3-C	3 Lockers	61" x 23 1/4" x 20"	12" x 20 1/2" x 12"	120	417	3.7	NEMA 5-15P	15093
F2GB-32-A	6 Lockers	61" x 14 3/4" x 34 3/4"	12" x 12" x 12"	120	627	5.5	NEMA 5-15P	21493
F2GB-32-C	6 Lockers	61" x 23 1/4" x 34 3/4"	12" x 20 1/2" x 12"	120	819	7.1	NEMA 5-15P	22244
F2GB-33-A	9 Lockers	61" x 14 3/4" x 49 5/8"	12" x 12" x 12"	120	933	8.2	NEMA 5-15P	28334
F2GB-33-C	9 Lockers	61" x 23 1/4" x 49 5/8"	12" x 20 1/2" x 12"	120	1221	10.6	NEMA 5-15P	29517
F2GB-42-A	8 Lockers	77 3/4" x 14 3/4" x 34 3/4"	12" x 12" x 12"	120	831	7.3	NEMA 5-15P	26462
F2GB-42-C	8 Lockers	77 3/4" x 23 1/4" x 34 3/4"	12" x 20 1/2" x 12"	120	1087	9.4	NEMA 5-15P	27711
F2GB-43-A	12 Lockers	77 3/4" x 14 3/4" x 49 5/8"	12" x 12" x 12"	120	1239	10.8	NEMA 5-15P	37173
F2GB-43-C	12 Lockers	77 3/4" x 23 1/4" x 49 5/8"	12" x 20 1/2" x 12"	120	1623	14.0	NEMA 5-15P [▲]	37912
F2GB-52-A	10 Lockers	94 5/8" x 14 3/4" x 34 3/4"	12" x 12" x 12"	120	1035	9.1	NEMA 5-15P	32381
F2GB-52-C	10 Lockers	94 5/8" x 23 1/4" x 34 3/4"	12" x 20 1/2" x 12"	120	1355	11.7	NEMA 5-15P	33261

▲ Canadian models use NEMA 5-20P.

All Locker System Models Feature:

Cord Location: Built-In Models: Operator side, bottom left.

OPTIONS (available at time of purchase only)

Designer Colors – Non-standard colors are non-returnable – Warm Red standard –

BLACK	Black	GRAY	Gray Granite	WHITE	White Granite	
NAVY	Navy Blue	GREEN	Hunter Green	COPPER	Antique Copper	No Charge
CNTRLPANEL_RIGHT						No Charge

Back Panels – Creates a non-pass-through unit – will be same color as unit – Not available on Built-In models – COUNTERTOP: The cord and power switch will move to the side of the unit, operators left, if right side is not selected at time of order. Subtract 15/16" to the depth and add 1 1/8" to width.

FLOOR MOUNT: The cord and power switch will move to the side of the unit, operators left, if right side is not selected at time of order. Subtract 15/16" to the depth and add 1 1/8" to width.

BPANEL3	Back panels in lieu of glass door for F2G-3 models	\$ -480
BPANEL4	Back panels in lieu of glass door for F2G-22 models	-640
BPANEL6	Back panels in lieu of glass door for F2G-32 models	-960
BPANEL8	Back panels in lieu of glass door for F2G-24 models	-1280
BPANEL12	Back panels in lieu of glass door for F2G-34 models	-1920
RGHTCRDLOCATION	Cord location moves to operator side, right lower corner, in lieu of standard operator side, left lower corner	No Charge
QR1	QR Code Reader for non-pass-through units. Must be combined with Back Panels	1128
QR2	QR Code Reader for pass-through units	2256

ACCESSORIES (available for purchase at any time)

ANTI-TIPBRACKT	Wall Mount Bracket (mounting hardware not included) (Floor Mount models only)	\$91
----------------	---	-------------

COLORS AND FINISHES – INSIDE BACK COVER



July 1, 2022

Flav-R 2-Go® Pizza Locker System

The Hatco Flav-R 2-Go® Floor Mount, Built-In, and Countertop Pizza Locker System - designed specifically for your pick-up and third-party delivery needs, is capable of holding multiple orders of hot or ambient pizza with quick and secure access. By reducing congestion and allowing employees to focus on other functions, customers or delivery people can arrive, access their specific locker, and leave without waiting in line or disturbing the flow of other business.

- A great solution to handling pick-up, third-party delivery and to-go orders in a non-contact manner
- Individual lockers can have the heat turned off for ambient storage
- Each locker unit has a large 10" (254 mm) touchscreen on the operator side and on the customer side. The operator puts in the name and code. The customer receives the code, enters it on the customer side, and the appropriate door unlocks.
- As a pass-through unit, customer side stays locked. When the access code is used, the door unlocks and opens for 30 seconds
- Available in *Designer* colors

Locker Leasing information now available. See website for more details



F2GP-12-C
in standard *Designer* Warm Red (Customer side shown)



F2GP-14-C
in standard *Designer* Warm Red (Customer side shown)

COUNTERTOP AND FLOOR MOUNT LOCKER SYSTEM

Model	Number of Lockers	Model Dimensions W x D x H	Internal Locker Dimensions (W x D x H)	Voltage	Watts	Amps	Plug	List Price
Countertop								
F2GP-12-C	4 Lockers	44 ¹ / ₈ " x 24 ⁷ / ₈ " x 31 ³ / ₄ "	20 ⁷ / ₈ " x 20 ¹ / ₂ " x 4 ²⁹ / ₃₂ "	120	536	4.7	NEMA 5-15P	\$21437
F2GP-21-C	4 Lockers	77 ⁷ / ₈ " x 24 ⁷ / ₈ " x 16 ⁷ / ₈ "	20 ⁷ / ₈ " x 20 ¹ / ₂ " x 4 ²⁹ / ₃₂ "	120	536	4.7	NEMA 5-15P	21437
F2GP-22-C	8 Lockers	77 ³ / ₄ " x 24 ⁷ / ₈ " x 31 ³ / ₄ "	20 ⁷ / ₈ " x 20 ¹ / ₂ " x 4 ²⁹ / ₃₂ "	120	1057	9.2	NEMA 5-15P	34647
Floor Mount								
F2GP-14-C	8 Lockers	44 ¹ / ₈ " x 24 ⁷ / ₈ " x 71 ¹ / ₄ "	20 ⁷ / ₈ " x 20 ¹ / ₂ " x 4 ²⁹ / ₃₂ "	120	1057	9.2	NEMA 5-15P	\$36175

All Locker System Models Feature:
Cord Location: Countertop Models: Operator side, right corner.
Floor Models: Operator side, right corner.

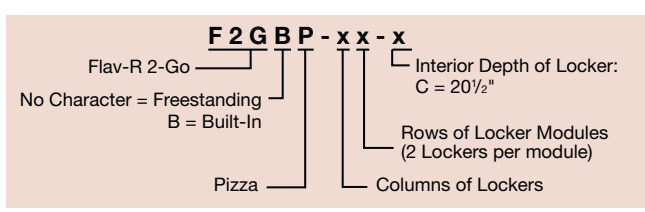

Flav-R 2-Go® Pizza Locker System continued



F2GBP-12-C
in standard
Designer
Warm Red
(Customer
side shown)

BUILT-IN LOCKER SYSTEM

Model	Number of Lockers	Model Dimensions W x D x H	Internal Locker Dimensions (W x D x H)	Voltage	Watts	Amps	Plug	List Price
Built-In								
F2GBP-12-C	4 Lockers	44 ¹ / ₈ " x 24 ⁷ / ₈ " x 34 ³ / ₄ "	20 ⁷ / ₈ " x 20 ¹ / ₂ " x 4 ²⁹ / ₃₂ "	120	536	4.7	NEMA 5-15P	\$22992
F2GBP-14-C	8 Lockers	44 ¹ / ₈ " x 24 ⁷ / ₈ " x 64 ³ / ₈ "	20 ⁷ / ₈ " x 20 ¹ / ₂ " x 4 ²⁹ / ₃₂ "	120	1057	9.2	NEMA 5-15P	35752
F2GBP-21-C	4 Lockers	77 ³ / ₄ " x 24 ⁷ / ₈ " x 19 ¹⁵ / ₁₆ "	20 ⁷ / ₈ " x 20 ¹ / ₂ " x 4 ²⁹ / ₃₂ "	120	536	4.7	NEMA 5-15P	22992
F2GBP-22-C	8 Lockers	77 ³ / ₄ " x 24 ⁷ / ₈ " x 34 ³ / ₄ "	20 ⁷ / ₈ " x 20 ¹ / ₂ " x 4 ²⁹ / ₃₂ "	120	1057	9.2	NEMA 5-15P	35752

All Locker System Models Feature:

Cord Location: Built-In Models: Operator side, bottom left corner.

OPTIONS (available at time of purchase only)

Designer Colors – Non-standard colors are non-returnable – Warm Red standard –

BLACK Black	GRAY Gray Granite	WHITE White Granite	
NAVY Navy Blue	GREEN Hunter Green	COPPER Antique Copper	No Charge
CNTRLPANEL_RGHT	Right side control panel, in lieu of standard left side location (F2GP-12-C and F2GBP-12-C models only)		No Charge
RGHTCRDLOCATION	Cord location moves to operator side, right lower corner, in lieu of standard operator side, left lower corner		No Charge
QR2	QR Code Reader for pass-through units		2256

ACCESSORIES (available for purchase at any time)

ANTI-TIPBRACKT	Wall Mount Bracket (mounting hardware not included) (Floor Mount models only)	\$91
-----------------------	---	-------------

COLORS AND FINISHES – INSIDE BACK COVER

NOTE: This unit is intended for stationary indoor, commercial use only—NOT for mobile applications.



July 1, 2022

Glo-Ray 2-Go™ Heated Shelves

The Hatco Glo-Ray 2-Go™ Heated Shelves are designed specifically with your delivery and carry-out needs in mind. Capable of holding a great quantity of hot food items at optimum serving temperatures, the GRS2G models hold bags and boxes up to 30 minutes with a high temperature range of up to 200°F.

- Shelves are 20" deep and 39" wide, large enough for pizza boxes and bags, which will easily fit into the 13" clearance of each shelf
- Touchscreen control with digital read out indicates separate heat and timer for each shelf
- Standard units feature shelves with heated bases that are thermostatically-controlled and have a stainless steel frame
- The cord is recessed into the bottom shelf at a 45° angle, allowing the unit to be flush against either wall



Quick-Ship Model pages 241-247

HEATED SHELVES

Model	Description	Dimensions W x D x H*	Voltage	Watts	Amps	Plug	Ship Weight	List Price
GRS2G-3920-2	2 heated shelves	43" x 20" x 21½"	120	704	5.6	NEMA 5-15P	150 lbs.	\$3418
GRS2G-3920-3	3 heated shelves	43" x 20" x 35¼"	120	1055	8.8	NEMA 5-15P	175 lbs.	4267
GRS2G-3920-4	4 heated shelves	43" x 20" x 50"	120	1406	11.7	NEMA 5-15P	200 lbs.	5113
GRS2G-3920-5	5 heated shelves	43" x 20" x 64¼"	120	1757	14.6	NEMA 5-15P [▲]	225 lbs.	5983

* Height does not include 1⅜" side wall mounting brackets.
[▲] Canadian models use NEMA 5-20P.

All Heated Shelf Models Feature:

Models shipped with: Side wall anchor brackets for improved stability, 6" adjustable flanged feet that can be bolted to the floor for additional stability and a 6' recessed cord and plug.
Cord Location: Server side, bottom right corner.

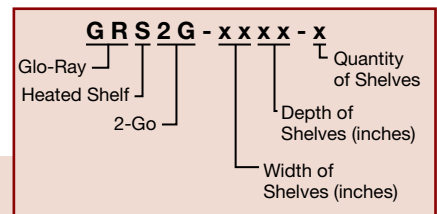

OPTIONS (available at time of purchase only)

Designer Colors – Non-standard colors are non-returnable – Stainless Steel standard –

RED Warm Red	BLACK Black	GRAY Gray Granite	WHITE White Granite
NAVY Navy Blue	GREEN Hunter Green	COPPER Antique Copper	

CONTROL-GRS2G-R Controls and permanent panel on customers right side in lieu of standard left side **No Charge**

Side Panels – will be same color as unit –

SPANEL GRS2G2	Side panels for a 2-shelf unit	\$ 89
GRS2G3	Side panels for a 3-shelf unit	179
GRS2G4	Side panels for a 4-shelf unit	268
GRS2G5	Side panels for a 5-shelf unit	357

Back Panels – will be same color as unit –

BPANEL GRS2G2	Back panels for a 2-shelf unit	\$ 77
GRS2G3	Back panels for a 3-shelf unit	153
GRS2G4	Back panels for a 4-shelf unit	229
GRS2G5	Back panels for a 5-shelf unit	306

ACCESSORIES (available for purchase at any time)

4" LEGS 4" Adjustable Legs (for GRS2G-3920-2 and GRS2G-3920-3 models only) **Set of 4 \$60**

COLORS AND FINISHES – INSIDE BACK COVER

Check out these other amazing Holding & Display Solutions!



FS3HAC-2426 with optional square side cut-outs and top sign holder (signs not included) and **FS3HAC-3626** shelf *pg. 149*



PDH-55T (bottom unit) with optional front glass panels below and **PSH-55D** (top unit). Both operator and customer sides shown. *pg. 151*



PFST-2X with standard stainless steel 8-shelf rack and **PFST-1XB** with standard Glossy White 8-shelf rack *pg. 184*

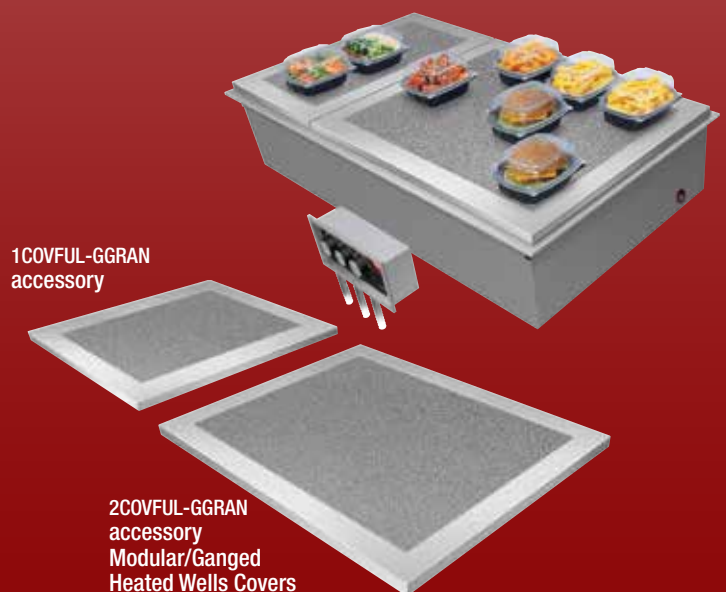

1COVFUL-GGRAN accessory

2COVFUL-GGRAN accessory
Modular/Ganged Heated Wells Covers

1COVFUL-GGRAN accessory and **2COVFUL-GGRAN** shown with **HWBI-3** for reference *pg. 40*

Wells

Cafeterias • Buffets
Convenience Stores • Supermarkets & Delis
Restaurants & Cafés • Clubs & Bars



DHWBI-3 with accessory pan support bars and food pans *pg. 12*



SW2-11QT with optional upper shelf, backsplash and LED lighting in *Designer Black* (accessories: cup rail, magnetic graphics, food pans and hinged lids [ladles not available]) *pg. 16*



HW-43 with accessory pan support bars (food pans, ladles and lids not available) *pg. 17*



HCWBI-3DA with accessory food pans *pg. 18*



IWB-6 with accessory food pan with two **HL5-60** (sneeze guards and bowls not available) *pg. 20*



CWB-S4 with optional **CWB-S4SLANT**, accessory pan support bars and food pans *pg. 25*



FTB-3 with accessory sheet pans *pg. 31*



HWBI-3 with accessory heated well covers (one **1COVFUL-GGRAN** and one **2COVFUL-GGRAN**) *pg. 36, 40*



HWBRT-7QTD and **HWBRT-11QTD** with accessory food pans and mounting kit (also shown **HWBL-43D**, **HWBLI-FULD** and **GR2AHL** with standard *Designer* non-adjustable stands, optional *Designer Black* and sneeze guards) *pg. 41-50*

Drop-In Modular/Ganged Dry Heated Wells Ordering Instructions

Cutaway of **DHWBI-2**
with accessory food pans and
pan support bars



Wells

Please specify the following with each order:

- 1. Desired Voltage (single phase):**
 DHWBI-1, -2, -3: 120V (single controls only)
 DHWBI-2, -3: 120/208-240V (single controls only)
 DHWBI-4, -5, -6: 120/208-240V (single or split controls)
- 2. Number of Modular/Ganged Dry Heated Wells Required:**
 Standard Configuration: 1-, 2-, 3-, 4-, 5- or 6-pan as rectangular, full-size (12" x 20")
- 3. Agency:**
 A. UL, C-UL
 B. UL-EPH (sanitary listing)

4. Control:

- A. Single Control Box (standard on all units)
- B. Split Controls Boxes (optional on 4-, 5-, 6-pan ganged units, not available in Canada)

Options

- 1. Bezel:**
 A. Standard: 23⁵/₈"
 B. Oversized: 27" allows a deep bezel to match Hatco's Refrigerated Drop-In Wells in a counter-top display
- 2. Attached Cord and Plug:**
 DHWBI-1, -2, -3, -4

Accessories for Modular/Ganged Heated Wells

- 1. Pan Support Bars:** 12" or 20"
- 2. Adapters** to convert Modular/Ganged units to hold 4- or 7-quart round pans
- 3. Stainless Steel Pans:**
 A. Third-size (12³/₄"W x 6⁷/₈"D x 2¹/₂"H)
 B. Half-size (12³/₄"W x 10³/₈"D x 2¹/₂"H)
 C. Full-size at 2¹/₂" deep (12³/₄"W x 20³/₄"D x 2¹/₂"H)
 D. Full-size at 4" deep (12³/₄"W x 20³/₄"D x 4"H)
 E. Full-size at 6" deep (12³/₄"W x 20³/₄"D x 6"H)

ACCESSORIES – PAGES 51-52

DROP-IN MODULAR/GANGED DRY HEATED WELLS COUNTERTOP CUT-OUTS

Model	Minimum Width	Maximum Width [▼]	Minimum Depth	Maximum Depth
DHWBI-1	14 ¹ / ₈ "	14 ³ / ₈ "	22 ¹ / ₄ "	22 ¹ / ₂ "
DHWBI-2	28 ¹ / ₈ "	28 ³ / ₈ "	22 ¹ / ₄ "	22 ¹ / ₂ "
DHWBI-3	42 ¹ / ₈ "	42 ³ / ₈ "	22 ¹ / ₄ "	22 ¹ / ₂ "
DHWBI-4	56 ¹ / ₈ "	56 ³ / ₈ "	22 ¹ / ₄ "	22 ¹ / ₂ "
DHWBI-5	70 ¹ / ₈ "	70 ³ / ₈ "	22 ¹ / ₄ "	22 ¹ / ₂ "
DHWBI-6	84 ¹ / ₈ "	84 ³ / ₈ "	22 ¹ / ₄ "	22 ¹ / ₂ "

[▼] Add 1/8" to Maximum Width when using EZ locking mount.

Drop-In Modular/ Ganged Dry Heated Wells

The Hatco Modular/Ganged Dry Heated Wells are full-size units that are grouped together in a modular fashion to provide customers with a complete heated food offering within one piece of equipment for a clean integrated look. Unlike traditional steam tables, this unit provides dry convected heat and is specifically designed to obtain the most accurate and consistent holding temperatures. Also offers increased design flexibility and reduced installation costs due to the lack of plumbing restrictions.

- Full-size, insulated dry wells available in 1- to 6-ganged units
- Features compact individual thermostatic controls for each well and a separate On/Off switch to retain settings
- Uniform convected air flow consistently surrounds the food pan for efficient heat transfer
- Easy-to-service design for quick replacement or service of elements
- ¾" NPT (National Pipe Thread) brass drain provides easy cleanup should any food spills occur, and provides additional protection to the motor and fan from any liquids that might accumulate in the well
- 6' conduit is standard for convenient placement of controls



DHWBI-2
with accessory (hotel)
food pans and additional
pan support bars



DHWBI-1

DROP-IN MODULAR/GANGED DRY HEATED WELLS

Model	Dimensions (W x D x H)	Single Control Voltage	Split Control Voltage	Watts	Ship Weight†	List Price
DHWBI-1	15½" x 23⅝" x 12⅞"	120V,	—	960	40 lbs.	\$ 2841
DHWBI-2	29½" x 23⅝" x 12⅞"	120, 120/208-240	—	1920	98 lbs.	4754
DHWBI-3	43½" x 23⅝" x 12⅞"	120, 120/208-240	—	2880	121 lbs.	6667
DHWBI-4	57½" x 23⅝" x 12⅞"	120/208-240	120, 120/208-240	3840	164 lbs.	8580
DHWBI-5	71½" x 23⅝" x 12⅞"	120/208-240	120	4804	196 lbs.	10493
DHWBI-6	85½" x 23⅝" x 12⅞"	120/208-240	120/208-240	4800	196 lbs.	10493
DHWBI-6	85½" x 23⅝" x 12⅞"	120/208-240	120, 120/208-240	5760	233 lbs.	12406

† Shipping weights are approximate.

All Drop-In Modular/Ganged Dry Heated Wells Feature:

Models Shipped with: EZ locking hardware for installation, electronic temperature control, baffles and stainless steel bezel.

OPTIONS (available at time of purchase only)

	Attached Cord and Plug for DHWBI-1, -2, -3, -4, single control and single phase only: DHWBI-1 (120V is NEMA-5-15P) DHWBI-2 (120V is NEMA-5-20P and 120/208-240V is NEMA L14-20P) DHWBI-3 (120V is NEMA-5-30P and 120/208-240V is NEMA L14-20P) DHWBI-4 (120/208-240V is NEMA L14-20P)	\$145
DHWBI-CORD		
OS-BEZEL27	27" D Bezel for Modular unit to match Hatco CWB models in a countertop display	No Charge

COUNTERTOP CUT-OUT DIMENSIONS – PAGE 11 ADDITIONAL ACCESSORIES – PAGES 51-52

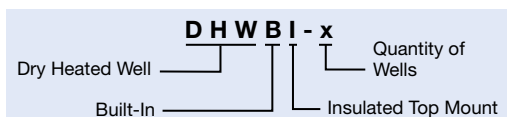

Modular/Ganged Dry Heated Wells Controls*

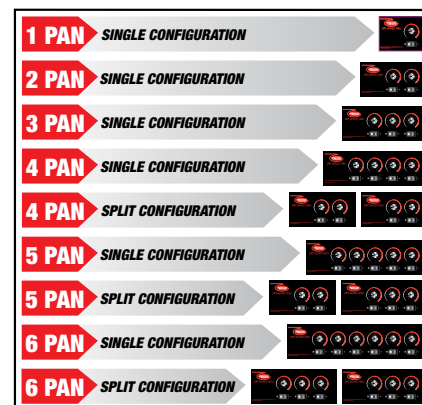

* 4-, 5-, 6-pan units: Single control box is standard. If optional split control boxes are desired, it must be specified at order (for Canada, split control boxes not available).

Drop-In Modular/Ganged Dry Slim Heated Wells Ordering Instructions

Cutaway of **DHWBI-S4** with accessory food pans and pan support bars

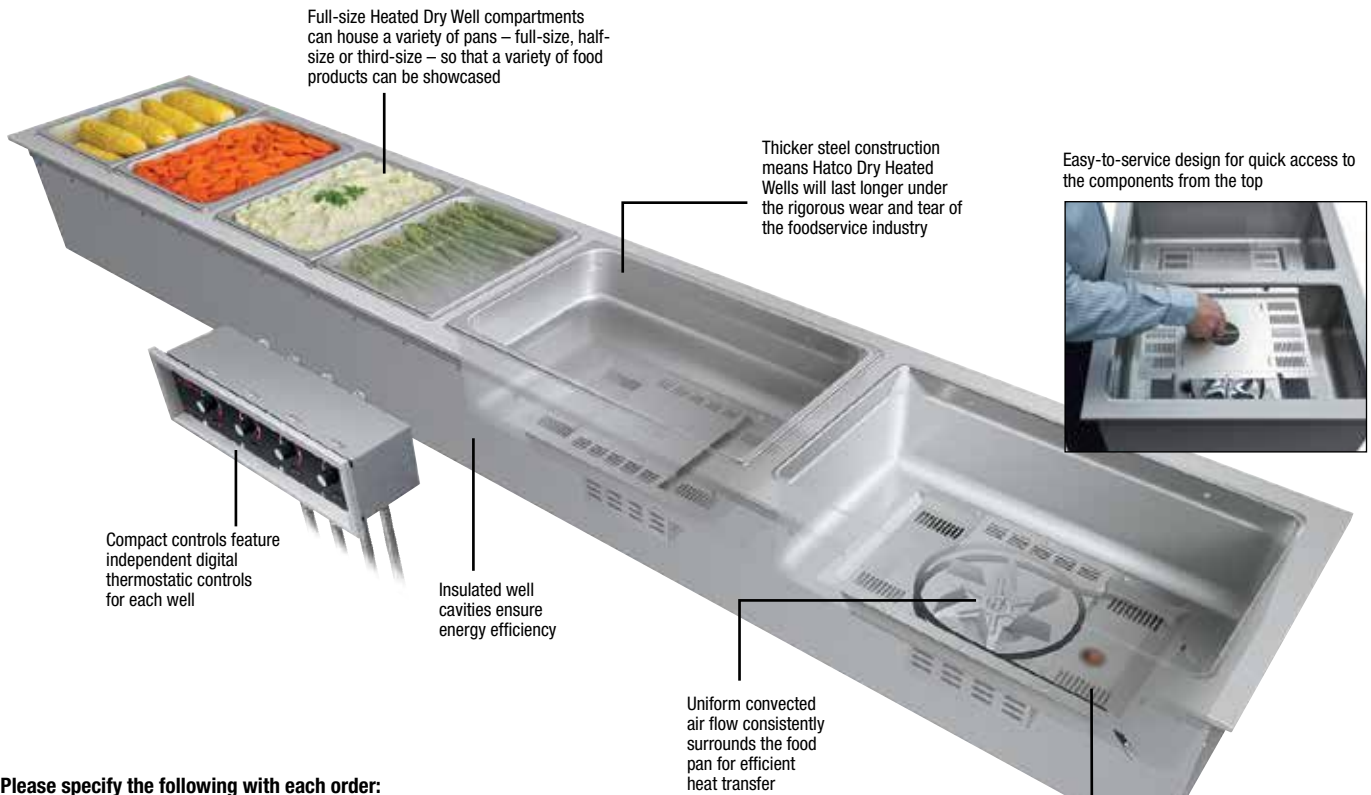

Please specify the following with each order:

1. **Desired Voltage** (single phase):
 DHWBI-S2, -S3: 120V
 DHWBI-S2, -S3, -S4: 120/208-240V
2. **Number of Modular/Ganged Dry Heated Wells Required:** 2-, 3- or 4-pan
 Modular/Ganged Slim units are only offered as rectangular, full-size (12" x 20") but placed lengthwise
3. **Agency:**
 A. UL, C-UL
 B. UL-EPH (sanitary listing)
4. **Control**
 A. Single Control Box (standard on all units)
 B. Split Control Boxes (optional on 4-pan units, not available in Canada)

Options

1. **Bezel:**
 A. Standard: 15⁵/₈"
 B. Oversized: 19" allows a deep bezel to match Hatco's Refrigerated Slim Drop-In Wells in a countertop display
2. **Attached cord and plug:**
 DHWBI-S2, -S3, -S4

Accessories for Modular/Ganged Heated Wells

1. **Pan Support Bars:** 12" or 20"
2. **Adapters** to convert Modular/Ganged units to hold 4- or 7-quart round pans
3. **Stainless Steel Pans:**
 A. Third-size (12³/₄"W x 6⁷/₈"D x 2¹/₂"H)
 B. Half-size (12³/₄"W x 10³/₈"D x 2¹/₂"H)
 C. Full-size at 2¹/₂" deep (12³/₄"W x 20³/₄"D x 2¹/₂"H)
 D. Full-size at 4" deep (12³/₄"W x 20³/₄"D x 4"H)
 E. Full-size at 6" deep (12³/₄"W x 20³/₄"D x 6"H)

ACCESSORIES – PAGES 51-52

DROP-IN MODULAR/GANGED DRY SLIM HEATED WELLS COUNTERTOP CUT-OUTS

Model	Minimum Width	Maximum Width [▼]	Minimum Depth	Maximum Depth
DHWBI-S2	43 ¹⁵ / ₁₆ "	44 ³ / ₁₆ "	14 ¹ / ₃₂ "	14 ⁹ / ₃₂ "
DHWBI-S3	65 ¹⁵ / ₁₆ "	66 ³ / ₁₆ "	14 ¹ / ₃₂ "	14 ⁹ / ₃₂ "
DHWBI-S4	87 ¹⁵ / ₁₆ "	88 ³ / ₁₆ "	14 ¹ / ₃₂ "	14 ⁹ / ₃₂ "

[▼]Add 1/16" to Maximum Width when using EZ locking mount.

Wells

Drop-In Modular/ Ganged Dry Slim Heated Wells

The Hatco Modular/Ganged Dry Slim Heated Wells are full-size units that are grouped together in a modular fashion but placed lengthwise. This provides customers with a complete heated food offering within easy reach, regardless of the sneeze guards. Unlike traditional steam tables, this unit provides dry convected heat and is specifically designed to obtain the most accurate and consistent holding temperatures. Also offers increased design flexibility and reduced installation costs due to the lack of plumbing restrictions.

- Full-size, insulated dry wells available in 2- to 4-ganged units
- Features compact individual thermostatic controls for each well and a separate On/Off switch to retain settings
- Uniform convected air flow consistently surrounds the food pan for efficient heat transfer
- Easy-to-service design for quick replacement or service of elements
- ¾" NPT (National Pipe Thread) brass drain provides easy cleanup should any food spills occur, and provides additional protection to the motor and fan from any liquids that might accumulate in the well
- 6" conduit is standard for convenient placement of controls

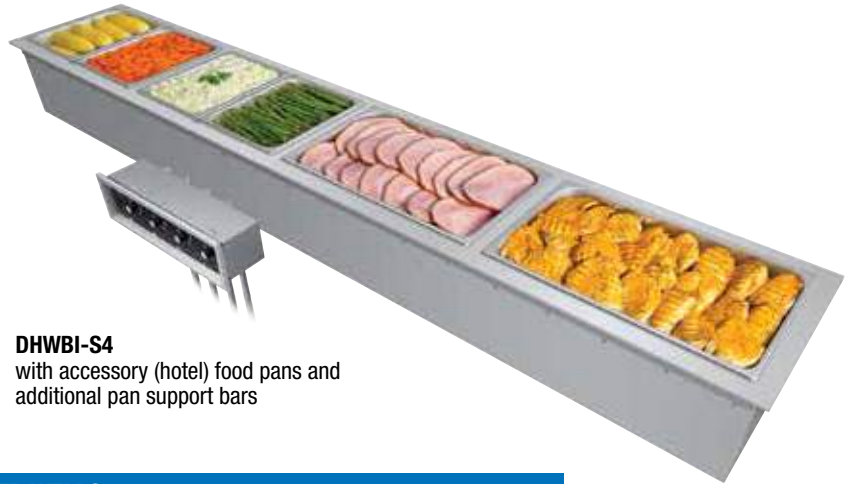

DHWBI-S4
with accessory (hotel) food pans and additional pan support bars

DROP-IN MODULAR/GANGED DRY SLIM HEATED WELLS

Model	Dimensions (W x D x H)	Single Control Voltage	Split Control Voltage	Watts	Ship Weight [†]	List Price
DHWBI-S2	45½" x 15 ⁵ / ₈ " x 12 ¹ / ₁₆ "	120V, 120/208-240	—	1920	94 lbs.	\$5081
DHWBI-S3	67½" x 15 ⁵ / ₈ " x 12 ¹ / ₁₆ "	120V, 120/208-240	—	2880	146 lbs.	7093
DHWBI-S4	89½" x 15 ⁵ / ₈ " x 12 ¹ / ₁₆ "	120/208-240	120V, 120/208-240	3840	177 lbs.	9105

[†] Shipping weights are approximate.

All Drop-In Modular/Ganged Dry Slim Heated Wells Feature:

Models Shipped with: EZ locking hardware for installation, electronic temperature control, baffles and stainless steel bezel.

OPTIONS (available at time of purchase only)

	Attached Cord and Plug for single control and single phase only: DHWBI-S2 (120V is NEMA-5-20P and 120/208-240V is NEMA L14-20P) DHWBI-S3 (120V is NEMA-5-30P and 120/208-240V is NEMA L14-20P) DHWBI-S4 (120/208-240V is NEMA L14-20P)	\$145
DHWBI-CORD		
OS-BEZEL19	19" D Bezel for Modular unit to match Hatco CWB Slim models in a countertop display	No Charge

Modular/Ganged Dry Heated Wells Controls*

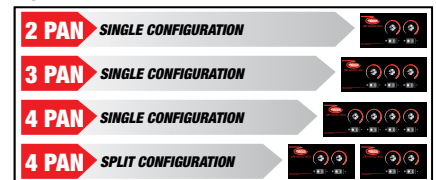

*4-pan units: Single control box is standard. If optional split control boxes are desired, it must be specified at order (for Canada, split control boxes not available).

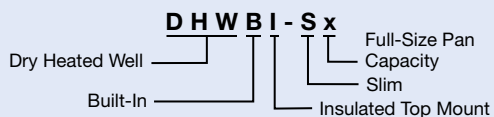

COUNTERTOP CUT-OUT DIMENSIONS – PAGE 13
ADDITIONAL ACCESSORIES – PAGES 51-52

Round Heated Wells

The multipurpose dry Heated Well from Hatco offers the flexibility of foodwarmers, soup kettles, Bain-Marie heaters, steamers and pasta cookers all in one! With a range of temperature settings, this unit can boil pasta and soup noodles, steam dim sum and warm and hold soups, curry, gravies and toppings at safe serving temperatures.

- Three temperature setpoints from 122°F to 212°F for warming, steaming and boiling
- Low power mode allows energy efficiency
- Single built-in model available (one 11-quart round pan)
- Freestanding units available as a single (one 11-quart round pan) or dual model (two 11-quart round pans) with individually-controlled pans



RHW-1
includes one RHW pan and lid



RHW-2
includes two RHW pans and lids (lids not shown)



RHW-1B includes one RHW pan, lid and remote control (ladle not included)

Wells

Quick-Ship Model pages 241-247

FREESTANDING ROUND HEATED WELLS

Model	Dimensions W x D x H	kW	Voltage Single Phase	Plug	Ship Weight	List Price
✓ RHW-1	14 ⁷ / ₈ " x 13" x 14"	1.3	120	NEMA 5-15P	20 lbs.	\$ 985
✓ RHW-2	24 ⁷ / ₈ " x 13" x 14"	2.0-2.7	208-240	NEMA 6-15P	36 lbs.	1524

All Freestanding Round Models Feature:

Liquid Capacity: RHW-1: 11-quart round pan (actual pan capacity: 6¹/₄ quarts for boiling application or 8¹/₂ quarts for warming application).

RHW-2: 2 x 11-quart round pans (actual pan capacity: 2 x 6¹/₄ quarts for boiling application or 2 x 8¹/₂ quarts for warming application).

RHW-1 Shipped with: One food holding pan and one pan lid.

RHW-2 Shipped with: Two food holding pans and two pan lids.

Cord Location: 72" cord and plug, back of unit.

Quick-Ship Model pages 241-247

BUILT-IN ROUND HEATED WELL

Model	Dimensions W x D x H	kW	Voltage Single Phase	Plug	Ship Weight	List Price
✓ RHW-1B	14 ³ / ₁₆ " x 13" x 13 ¹ / ₁₆ "	1.3	120	NEMA 5-15P	21 lbs.	\$920

All Built-In Round Models Feature:

Liquid Capacity: 11-quart round pan (actual pan capacity: 6¹/₄ quarts for boiling application or 8¹/₂ quarts for warming application).

RHW-1B Shipped with: One food holding pan, one pan lid and remote control.

Cord Location: 56" cable from well to control box with a 6' cord and plug located at the back of the control box.

Recommended Well Cut-Out Size: 11¹/₄" diameter.

ACCESSORIES (available for purchase at any time)

RHW -		
RHW-11QT-LID-HG	RHW Hinged Lid for 11-Quart Round Pan	\$102
RHW-11QT-POT	RHW 11-Quart Round Pan	135

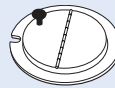

RHW-11QT-LID-HG
Hinged lid for 11-quart round pan

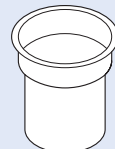

RHW-11QT-POT
11-quart round pan

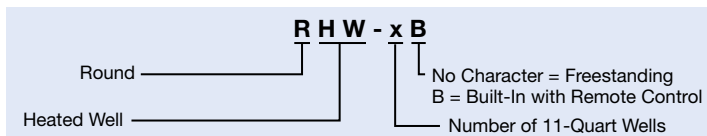



Soup Stations

Hatco's Soup Station is designed to provide an attractive appearance while holding pre-heated soups at safe-serving temperatures – whether it's front of the house, self-serve kiosks or catering.

Heat is evenly distributed throughout the unit to hold foods at optimum temperatures, and the insulated stainless steel design provides easy maintenance and durable performance.

- Unit available to accommodate two 7-quart or two 11-quart round pans
- Stainless steel construction with insulation that provides easy maintenance and durable performance
- Infinite switch with indicator light on both ends of unit controls nearest well
- Convenient recessed handles
- Comes with 6' cord and plug attached



SW2-11QT



SW2-7QT in optional Designer color

SOUP STATIONS

Model	Dimensions W x D x H	Voltage Single Phase	Watts	Plug	Ship Weight	List Price
SW2-7QT	25½" x 15¾" x 10¼"	120	750	NEMA 5-15P	34 lbs.	\$1511
SW2-11QT	25½" x 15¾" x 10¼"	120	750	NEMA 5-15P	53 lbs.	1555

All Soup Station Models Feature:

Models Shipped with: Two heating elements, indicator light, infinite switch and controls located at each end of unit.
Cord Location: Back of unit.

OPTIONS (available at time of purchase only)

Designer Color – Non-standard colors are non-returnable –		No Charge
SS	Base unit in Stainless Steel (standard)	
BLACK	Base unit in Designer Black	\$215
Upper Shelf with LED Lights – (includes a Reversible Back that fits Magnetic Graphics [not included] or reverse for a Sign Holder to insert your custom signage) – Non-standard colors are non-returnable –		
SW2-US-LED	Stainless Steel (standard) – add 7/8" to depth, 16¼" to height	\$690
SW2-US-LED-BK	Designer Black – add 7/8" to depth, 16¼" to height	757



SW2-US-LED Upper shelf with LED lights and reversible back for magnetic graphics or reverse for a sign holder to insert your custom signage

ACCESSORIES (available for purchase at any time)

Reversible Back – (fits Magnetic Graphics [not included] or reverse the back for a Sign Holder to insert your custom signage) – Non-standard colors are non-returnable –		
SW2-BACK	Reversible Back (with posts) in Stainless Steel, graphic not included (add 13½" to height and 7/8" to depth)	\$301
SW2-BACK-BK	Reversible Back (with posts) in Designer Black, graphic not included (add 13½" to height and 7/8" to depth)	364

SW2-BACK Reversible back (with posts) in Stainless Steel, fits magnetic graphics (not included) or reverse the back for sign holder to insert your custom signage



Reversible back with back splash shown



Reversible back with signholder shown

SW2-4.5RAIL
Cup rail accessory



Cup Rail –		
SW2-4.5RAIL	Cup Rail in Stainless Steel (add 4½" to depth)	\$ 93
SW2-4.5RAIL-BK	Cup Rail in Designer Black (add 4½" to depth)	113

Magnetic Graphics (for Base and Reversible Back) –		
SW2-BASEGRPHCS	Magnetic Base Graphics (covers 3 sides - front and both sides of Soup Station)	\$266
SW2-BACKSGRPHC	Magnetic Back Graphic (Backsplash Graphic Area: 23¼"W x 11¾"D)	131



SW2-BASEGRPHCS
Three magnetic base graphic accessories (covers 3 sides of base)

SW2-BACKSGRPHC
Magnetic reversible back accessory



PAN AND LID ACCESSORIES – PAGE 51

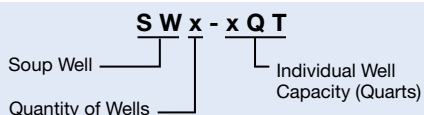

Countertop Heated Wells

Providing versatility and reliability, Hatco Countertop Heated Wells hold food hot and fresh in either a wet or dry operation with an adjustable temperature control. The -FUL units can hold a full-size pan or three third-size pans, while the -43 units can hold a full-size pan with a third-size pan or four third-size pans. The HW series are hold only, while the CHW series are capable of rethermalizing a variety of foods as well as holding (cook and hold).

- Controls feature a separate lighted On/Off rocker switch and adjustable temperature dial
- May be used dry but performs best when used with water. Dry indicator light informs user to add water

- Thicker .8 mm stainless steel pan with a stainless steel housing (aluminized steel bottom)
- Pan edge offset to help keep condensation from dripping onto countertop surface



HW-FUL with accessory food pans and pan support bar



CHW-43
with accessory food pans and pan support bar (single unit holding 1 full-size pan and 1 third-size pan)

Wells

Quick-Ship Model pages 241-247

HOLD ONLY COUNTERTOPS – FULL-SIZE AND 4/3-SIZE

Model	Dimensions W x D x H	Voltage	Watts	Plug	Ship Weight	List Price
Standard Watt						
✓ HW-FUL	14½" x 24" x 9¾"	120	1200	NEMA 5-15P	29 lbs.	\$607
✓ HW-43	14½" x 31" x 9¾"	120	1200	NEMA 5-15P	33 lbs.	761

Quick-Ship Model pages 241-247

COOK & HOLD COUNTERTOPS – FULL-SIZE AND 4/3-SIZE

Model	Dimensions W x D x H	Voltage	Watts	Plug	Ship Weight	List Price
High Watt						
✓ CHW-FUL	14½" x 24" x 10¾"	120	1440	NEMA 5-15P	29 lbs.	\$690
✓ CHW-43	14½" x 31" x 10¾"	120	1800	NEMA 5-15P NEMA 5-20P (Canada only)	35 lbs.	799

All Countertop Heated Well Models Feature:

Voltage: Single phase.

Cord Location: Bottom left corner on back of unit.

Models Shipped with: Stainless steel pan, stainless steel (aluminized stainless steel bottom) housing with a metal sheathed heating element, a power On/Off switch, a temperature control, a dry unit indicator light and a 6' cord with plug attached.

ACCESSORIES (available for purchase at any time)

HW-2-7QT	Adapter to convert warmer to hold two 7-Quart Inserts (models HW-FUL, CHW-FUL only)	\$ 93
HW-3-4QT	Adapter to convert warmer to hold three 4-Quart Inserts (models HW-FUL, CHW-FUL only)	93
HW-2-11QT	Adapter to convert warmer to hold two 11-Quart Inserts (models HW-43, CHW-43 only)	117
HW-4-4QT	Adapter to convert warmer to hold four 4-Quart Inserts (models CHW-43, HW-FUL-43 series only)	93
HW12BAR	12" Pan Support for Countertop Wells	20
HW20BAR	20" Pan Support for Countertop Wells	24

ADDITIONAL PAN AND LID ACCESSORIES – PAGES 51-52

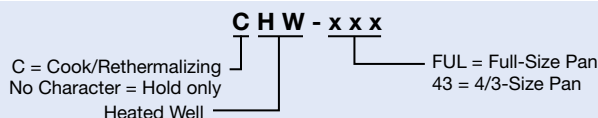

HW-4-4QT



Drop-In Hot/Cold Wells

Whether it is breakfast in the morning or a salad bar at lunch, this well incorporates the legendary Hatco quality of both the hot and cold units into one.

- Accommodates full-size pans
- Cold Mode: Similar to Hatco's CWB Cold Well, including auto-defrost, easy serviceability, optimal insulation and efficient condenser. Includes cold mode pan supports
- Hot Mode: Utilizes the same time-tested FR2 Hydro-Heater (Bain Marie) with "free flow" technology for an efficient and safe operation with a longer life, and includes drain, auto-fill and hot mode frame for pan supports
- Simple controls for ease of use
- Adjustable set points to keep your particular food items at optimum temperatures
- Remote control box that can be mounted to a front counter for easy access (any vertical surface within approximately five feet)



HCWBI-2DA shown in **hot** mode with heated pan support bars (included), designed for easier handling of food pans



HCWBI-2DA shown in **cold** mode with cold pan support bars (included) and accessory food pans

DROP-IN HOT/COLD WELLS

Model	Dimensions W x D x H	HP	Watts Hot Mode	Ship Weight	List Price			
					120/208V		120/240V	
					Single Phase	Three Phase	Single Phase	Three Phase
HCWBI-2DA	32" x 27" x 26 ¹ / ₈ "	1 ¹ / ₂	3000	209 lbs.	\$13191	\$14196	—	\$14196
HCWBI-3DA	45" x 27" x 26 ¹ / ₈ "	1 ¹ / ₂	3000	241 lbs.	13599	14604	—	14604
HCWBI-4DA	58" x 27" x 26 ¹ / ₈ "	1 ² / ₃	4000	282 lbs.	14187	15192	\$14187	15192
HCWBI-5DA	71" x 27" x 26 ¹ / ₈ "	5 ¹ / ₈	6000	351 lbs.	16022	17027	—	17027
HCWBI-6DA	84" x 27" x 26 ¹ / ₈ "	5 ¹ / ₈	6000	358 lbs.	17744	18749	—	18749

All models utilize R-513A Refrigerant.

All Drop-In Hot/Cold Well Models Feature:

Models Shipped with: Electronic temperature control, pan support bars for full-size pans (one set each: hot and cold mode), Bain-Marie, low-water cut-off (LWCO), condensing unit, auto-defrost, sight glass, service valves and dryer. Consult factory for refrigerant specifications.

OPTIONS (available at time of purchase only)

EWC	Additional Four Year Parts Only Warranty on the Compressor (HCWBI and HCWBIR series only)	\$200
Gasket Options –		
BEZELGASKET-2	Factory installed for HCWBI-, HCWBIR- and HCWBIX-2DA	\$ 87
BEZELGASKET-3	Factory installed for HCWBI-, HCWBIR- and HCWBIX-3DA	114
BEZELGASKET-4	Factory installed for HCWBI-, HCWBIR- and HCWBIX-4DA	114
BEZELGASKET-5	Factory installed for HCWBI-, HCWBIR- and HCWBIX-5DA	122
BEZELGASKET-6	Factory installed for HCWBI-, HCWBIR- and HCWBIX-6DA	122

ACCESSORIES (available for purchase at any time)

FR2-FLUSH	Flush Hose, Cleaning Brush, Stopper and Adapter	\$106
CWB12BAR	12" Pan Support for Drop-In Refrigerated Wells	22
CWB20BAR	20" Pan Support for Drop-In Refrigerated Wells	26

PANS AND TRIVET ACCESSORIES – PAGE 22

DROP-IN HOT/COLD WELLS COUNTERTOP CUT-OUTS

Model	Minimum Width	Maximum Width	Minimum Depth	Maximum Depth
HCWBI-2DA	30 ¹ / ₈ "	31"	25 ³ / ₁₆ "	26"
HCWBI-3DA	43 ¹ / ₈ "	44"	25 ³ / ₁₆ "	26"
HCWBI-4DA	56 ¹ / ₈ "	57"	25 ³ / ₁₆ "	26"
HCWBI-5DA	69 ¹ / ₈ "	70"	25 ³ / ₁₆ "	26"
HCWBI-6DA	82 ¹ / ₈ "	83"	25 ³ / ₁₆ "	26"

HCWBI x - x DA

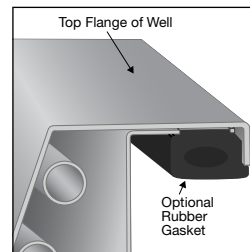
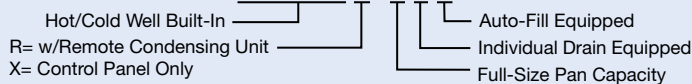

BEZELGASKET-2, -3, -4, -5, -6
Factory installed option (eliminates the need for silicone or other sealants)



FR2-FLUSH

Support Bars
Choose the appropriate kit for HCWBI series



Remote Drop-In Hot/Cold Wells

Whether it is breakfast in the morning or a salad bar at lunch, this well incorporates the legendary quality of both the hot and cold units into one, but in a remote configuration that offers unlimited flexibility for your own particular dining design needs.

HCWBIR-2DA
with condensing unit (shipped loose) and control panel



Hot Mode: **HCWBIR-2DA** shown with accessory food pans and hot mode pan supports (included), which are designed specifically for easier and safer handling of foods.

HCWBIX-2DA
with control panel



Cold Mode: **HCWBIX-2DA** shown with accessory food pans and cold pan support bars. Unique angled inside wall design provides easy access and clear views, while allowing cold air to effectively blanket your food product.

Standard features

- Can house a variety of pans, full-size, half-size or third-size and are available in a two through six pan configuration
- Cold Mode: Similar to Hatco's CWB Cold Well, including auto-defrost, easy serviceability, optimal insulation and efficient condenser. Includes cold mode pan supports
- Hot Mode: Utilizes the same time-tested FR2 Hydro-Heater (Bain Marie) with "free flow" technology for an efficient and safe operation with a longer life, and includes drain, auto-fill and hot mode frame for pan support

• HCWBIR-xx models only:

- Condenser utilizes R-513A refrigerant
- Includes a condensing unit (shipped loose - can be field mounted up to 50' of tubing from unit), an attached FR2 Hydro-Heater, control panel and TXV valve (TXV is shipped loose)

• HCWBIX-xx models only:

- Includes control panel and FR2 Hydro-Heater but without a condensing unit for the increased flexibility of multiple hot/cold well configurations
- Solenoid valve attached to cold well with a TXV valve (TXV is shipped loose)

DROP-IN HOT/COLD WELLS – WITH CONDENSING UNIT AND REMOTE CONTROL PANEL

Model	Dimensions W x D x H	HP	Watts Hot Mode	Ship Weight	List Price			
					120/208V		120/240V	
					Single Phase	Three Phase	Single Phase	Three Phase
HCWBIR-2DA	32" x 27" x 26 5/8"	1/5	3000	214 lbs.	\$12850	\$13855	—	\$13855
HCWBIR-3DA	45" x 27" x 26 5/8"	1/5	3000	237 lbs.	\$13257	14262	—	14262
HCWBIR-4DA	58" x 27" x 26 5/8"	1/3	4000	285 lbs.	\$13816	14821	\$13816	14821
HCWBIR-5DA	71" x 27" x 26 5/8"	5/6	6000	343 lbs.	\$15590	16595	—	16595
HCWBIR-6DA	84" x 27" x 26 5/8"	5/6	6000	370 lbs.	\$17312	18317	—	18317

All models utilize R-513A Refrigerant.

All Remote Drop-In Hot/Cold Wells with a Condensing Unit and Remote Control Feature:

Models Shipped with: Remote-mounted control box, remote-mounted condensing unit and a TXV valve (shipped loose).

DROP-IN HOT/COLD WELLS – WITH REMOTE CONTROL PANEL (without a condensing unit)

Model	Dimensions W x D x H	Load/BTU Hour	Hz	Ship Weight	List Price			
					120/208V		120/240V	
					Single Phase	Three Phase	Single Phase	Three Phase
HCWBIX-2DA	32" x 27" x 26 5/8"	630	60	165 lbs.	\$11764	\$12769	—	\$12769
HCWBIX-3DA	45" x 27" x 26 5/8"	930	60	188 lbs.	\$12172	\$13177	—	\$13177
HCWBIX-4DA	58" x 27" x 26 5/8"	1230	60	235 lbs.	\$12725	\$13730	\$12725	\$13730
HCWBIX-5DA	71" x 27" x 26 5/8"	1530	60	268 lbs.	\$14194	\$15199	—	\$15199
HCWBIX-6DA	84" x 27" x 26 5/8"	1830	60	295 lbs.	\$15916	\$16921	—	\$16921

All models utilize R-513A Refrigerant.

All Remote Drop-In Hot/Cold Wells with a Remote Control (without a Condensing Unit) Feature:

Models Shipped with: Remote-mounted control box, a TXV valve (shipped loose) and a solenoid valve attached to well.

HCWBIX-xxDA

- Hot/Cold Well Built-In
- R= w/Remote Condensing Unit
- X= Control Panel Only
- Auto-Fill Equipped
- Individual Drain Equipped
- Full-Size Pan Capacity

OPTIONS, CUT-OUT DIMENSIONS AND ACCESSORIES – PAGE 18
PANS AND TRIVET ACCESSORIES – PAGE 22

Drop-In Ice Wells

Hatco Drop-In Ice Wells provide all the quality features of our Refrigerated Drop-Ins, but without any refrigeration or electrical components. These ice-cooled, insulated units can hold pre-chilled food products at preferred serving temperatures. Ideal for salad bars, cold buffets and chilled beverage bars. Pan dividers give you greater flexibility in your variety of featured food products.

- Full-size, insulated, top mount wells available to hold 1- to 6-pan configurations
- Optimal insulation on sides and bottom to ensure better cold retention and cost savings
- Bezel design allows clear viewing and easy food access
- Larger 1" NPT (National Pipe Thread) brass drain with flat screen simplifies cleaning
- False bottom accessory conveniently holds ice above drain for ease of draining
- Matches the Hatco line of Wells for a fully integrated look



IWB-2 with slant option **IWB-2SLANT**



IWB-6 with an accessory food pan (bowls not available) and an optional gasket

DROP-IN INSULATED ICE WELLS

Model	Dimensions W x D x H	Ship Weight	List Price
IWB-1	19" x 27" x 12"	62 lbs.	\$1833
IWB-2	32" x 27" x 12"	83 lbs.	2111
IWB-3	45" x 27" x 12"	102 lbs.	2446
IWB-4	58" x 27" x 12"	144 lbs.	2835
IWB-5	71" x 27" x 12"	110 lbs.	3281
IWB-6	84" x 27" x 12"	180 lbs.	3784

OPTIONS (available at time of purchase only)

Slant Options –

IWB-1SLANT	Slant Option for IWB-1	\$269
IWB-2SLANT	Slant Option for IWB-2	290
IWB-3SLANT	Slant Option for IWB-3	311
IWB-4SLANT	Slant Option for IWB-4	332
IWB-5SLANT	Slant Option for IWB-5	353
IWB-6SLANT	Slant Option for IWB-6	374

Gasket Options –

BEZELGASKET-1	Factory installed for IWB-1	\$ 87
BEZELGASKET-2	Factory installed for IWB-2	87
BEZELGASKET-3	Factory installed for IWB-3	114
BEZELGASKET-4	Factory installed for IWB-4	114
BEZELGASKET-5	Factory installed for IWB-5	122
BEZELGASKET-6	Factory installed for IWB-6	122

ACCESSORIES – PAGE 22

Slant Option for:

IWB-1, -2, -3, -4, -5, -6

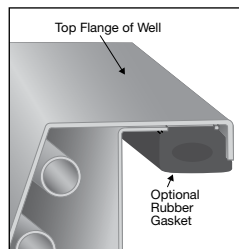
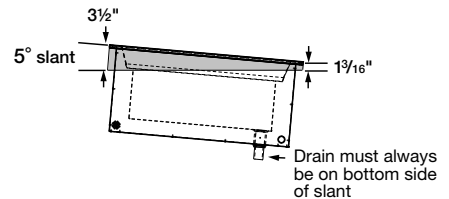

BEZELGASKET-1
Factory installed option (eliminates the need for silicone or other sealants)

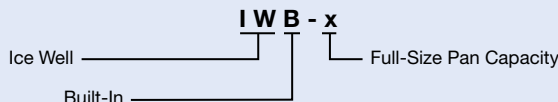

DROP-IN ICE WELL COUNTERTOP CUT-OUTS

Model	Minimum Width	Maximum Width	Minimum Depth	Maximum Depth
IWB-1	17 1/8"	18"	25 3/16"	26"
IWB-2	30 3/8"	31"	25 3/16"	26"
IWB-3	43 3/8"	44"	25 3/16"	26"
IWB-4	56 3/8"	57"	25 3/16"	26"
IWB-5	69 3/8"	70"	25 3/16"	26"
IWB-6	82 3/8"	83"	25 3/16"	26"

Drop-In Slim Ice Wells

Hatco Drop-In Slim Ice Wells provide all the quality features of our Refrigerated Drop-Ins, but without any refrigeration or electrical components. Now available in a slim configuration providing customers with a complete well within easy reach, regardless of the sneeze guards.

Ideal for salad bars, cold buffets and chilled beverage bars. Pan dividers give you greater flexibility in your variety of featured food products.

- Holds 1- to 4-full-size pan configurations, but placed lengthwise
- Optimal insulation on sides and bottom to ensure better cold retention and cost savings
- Bezel design allows clear viewing and easy food access
- Larger 1" NPT (National Pipe Thread) brass drain with flat screen simplifies cleaning
- False bottom accessory conveniently holds ice above drain for ease of draining



IWB-S4
with optional
IWB-S4SLANT



IWB-S2

DROP-IN INSULATED SLIM ICE WELLS

Model	Dimensions W x D x H	Ship Weight	List Price
IWB-S1	27 ¹ / ₁₆ " x 19" x 12"	58 lbs.	\$1903
IWB-S2	48 ¹ / ₈ " x 19" x 12"	105 lbs.	2181
IWB-S3	69 ³ / ₁₆ " x 19" x 12"	145 lbs.	2516
IWB-S4	90 ¹ / ₄ " x 19" x 12"	202 lbs.	2905

OPTIONS (available at time of purchase only)

Slant Options –

IWB-S1SLANT	Slant Option for IWB-S1	\$269
IWB-S2SLANT	Slant Option for IWB-S2	290
IWB-S3SLANT	Slant Option for IWB-S3	311
IWB-S4SLANT	Slant Option for IWB-S4	332

Gasket Options –

BEZELGASKET-S1	Factory installed for IWB-S1	\$ 87
BEZELGASKET-S2	Factory installed for IWB-S2	87
BEZELGASKET-S3	Factory installed for IWB-S3	114
BEZELGASKET-S4	Factory installed for IWB-S4	114

ACCESSORIES – PAGE 22

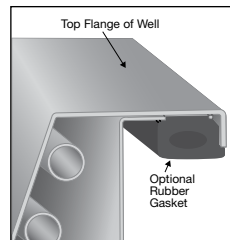
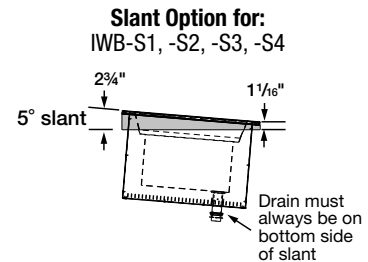

BEZELGASKET-S1
Factory installed option (eliminates the need for silicone or other sealants)

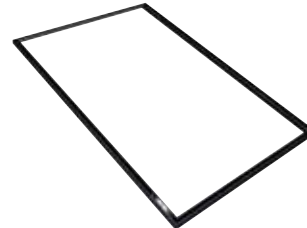

DROP-IN SLIM ICE WELLS COUNTERTOP CUT-OUTS

Model	Minimum Width	Maximum Width	Minimum Depth	Maximum Depth
IWB-S1	25 ¹ / ₄ "	26 ¹ / ₁₆ "	17 ¹ / ₁₆ "	17 ¹⁵ / ₁₆ "
IWB-S2	46 ¹ / ₄ "	47 ¹ / ₈ "	17 ¹ / ₁₆ "	17 ¹⁵ / ₁₆ "
IWB-S3	67 ⁷ / ₁₆ "	68 ³ / ₁₆ "	17 ¹ / ₁₆ "	17 ¹⁵ / ₁₆ "
IWB-S4	88 ³ / ₈ "	89 ¹ / ₄ "	17 ¹ / ₁₆ "	17 ¹⁵ / ₁₆ "

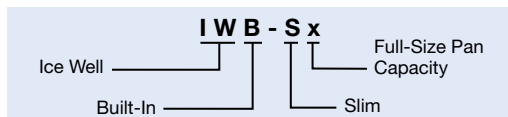

Drop-In Ice Well Accessories *(available for purchase at any time)*



IWB-6
with accessory food pan
(bowls not available)

PANS – TRIVETS *(available for purchase at any time)*

ST PAN 1/3	Third-Size Stainless Steel Pan – 12¾"W x 6⅞"D x 2½"H	\$ 64
ST PAN 1/2	Half-Size Stainless Steel Pan – 12¾"W x 10⅞"D x 2½"H	74
ST PAN 2	Full-Size Stainless Steel Pan – 12¾"W x 20¾"D x 2½"H	88
ST PAN 4	Full-Size Stainless Steel Pan – 12¾"W x 20¾"D x 4"H	110
HDW 6" PAN	Full-Size Stainless Steel Pan – 12¾"W x 20¾"D x 6"H	120
Wire Trivets Stainless –		
TRIVET (1/2)SS	Half-Size – 10⅞"W x 7⅞"D	\$119
TRIVET SS	Full-Size – 10⅞"W x 18"D	165

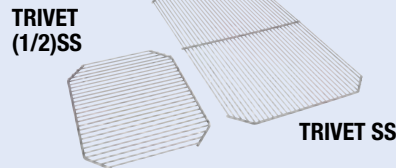

Support Bars
Choose the appropriate
kit for IWB or
CWB series

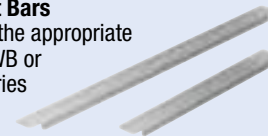

SUPPORT BARS – FALSE BOTTOMS *(available for purchase at any time)*

Bars –		
CWB12BAR	12" Pan Support Bar for Drop-In Ice or Refrigerated Wells	\$22
CWB20BAR	20" Pan Support Bar for Drop-In Ice or Refrigerated Wells	26

False Bottoms for Ice Wells (allows for 3½" of ice and sits on ledge of well) –		
1FB3.5	For IWB-1 models (includes one 1-pan Insert)	\$102
2FB3.5	For IWB-2 models (includes one 2-pan Insert)	187
3FB3.5	For IWB-3 models (includes one 1-pan Insert and one 2-pan Insert)	272
4FB3.5	For IWB-4 models (includes two 2-pan Inserts)	357
5FB3.5	For IWB-5 models (includes one 1-pan Insert and two 2-pan Inserts)	442
6FB3.5	For IWB-6 models (includes three 2-pan Inserts)	527

False Bottoms for Slim Ice Wells (allows for 3½" of ice and sits on ledge of well) –		
1FB3.5	For IWB-S1 models (includes one 1-pan Insert)	\$102
2FB3.5	For IWB-S2 models (includes one 2-pan Insert)	187
3FB3.5	For IWB-S3 models (includes one 1-pan Insert and one 2-pan Insert)	272
4FB3.5	For IWB-S4 models (includes two 2-pan Inserts)	357

False Bottoms for Ice Wells (allows for 8" of ice and sits on bottom of well) –		
1FB8	For IWB-1 models (includes one 1-pan Insert)	\$102
2FB8	For IWB-2 models (includes one 2-pan Insert)	187
3FB8	For IWB-3 models (includes one 1-pan Insert and one 2-pan Insert)	272
4FB8	For IWB-4 models (includes two 2-pan Inserts)	357
5FB8	For IWB-5 models (includes one 1-pan Insert and two 2-pan Inserts)	442
6FB8	For IWB-6 models (includes three 2-pan Inserts)	527

False Bottoms for Slim Ice Wells (allows for 8" of ice and sits on bottom of well) –		
1FB8	For IWB-S1 models (includes one 1-pan Insert)	\$102
2FB8	For IWB-S2 models (includes one 2-pan Insert)	187
3FB8	For IWB-S3 models (includes one 1-pan Insert and one 2-pan Insert)	272
4FB8	For IWB-S4 models (includes two 2-pan Inserts)	357

2FB8 Accessory

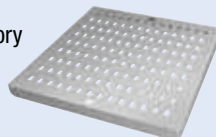

False Bottom Accessories

1-part, 2-part or 3-part(s) depending on pan size

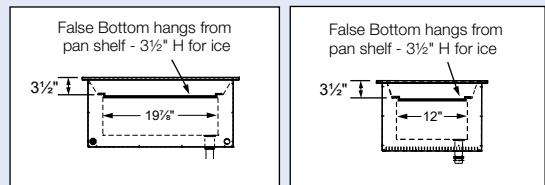

(1, 2, 3, 4, 5 or 6FB3.5)
for the IWB Series

(1, 2, 3 or 4FB3.5)
for the IWB-S Series

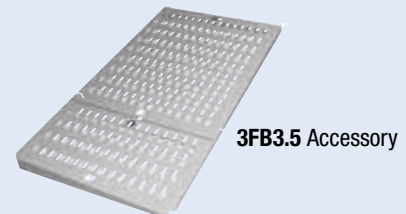

3FB3.5 Accessory

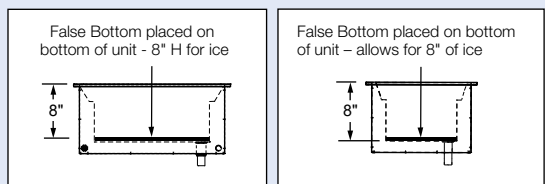

(1, 2, 3, 4, 5 or 6FB8)
for the IWB Series

(1, 2, 3 or 4FB8)
for the IWB-S Series

Refrigerated Drop-In Wells Ordering Instructions

Cutaway of CWB-6 with accessory food pans

NSF 7 Component approved cold wall construction, keeping food product cold without drying it out

A Refrigerated Well when combined with accessory support bars can house a variety of pans – full-size, half-size or third-size – showcasing a variety of your food products

The greater surface area of the angled wall and the placement of the coils allow cold air to more effectively blanket your food product

The unique top bezel design also provides easy access and clear views

3"

Larger brass drain ensures easy cleaning

Exclusive flat screen design ensures that pans sit flush

Adjustable condensing unit can rotate 90° or 180° on all models for easy venting adjustments and flexible installation

For the CWB-4, -5 or -6 and CWB-S2, -S3 or S4 models the mobile condensing unit can be mounted in several positions between the center of the well and the evaporator coil connections

The well cavity ensures energy efficiency with environmentally-friendly insulation used throughout

Long, flexible refrigerant lines for easy pull-out and service

Auto-defrost activated through an advanced electronic controller programmed at the customer location

Easy-to-service pull-out design

Please specify the following with each order:

- Desired Voltage:**
120V, single phase
- Number of Drop-In Wells Required:**
 - Standard Configuration**
1-, 2-, 3-, 4-, 5- or 6-pan as rectangular, full-size (12" x 20")
 - Slim configuration**
S1-, S2-, S3- or S4-pan as rectangular, full-size (12" x 20") but placed lengthwise
- Depth of Model:** Standard configuration (27"D) or Slim configuration (19"D)
- Agency** – UL, C-UL, NSF 7 Component
- Electronic Control Assembly** can be mounted on either side of the Condensing Unit or remotely mounted up to 4' from the unit (cannot be mounted over the Condensing Unit)

Options

- Additional four year parts only warranty on the Compressor available at the time of unit purchase
- Slant Option** for CWB-1, -2, -3, -4, -5, -6 or CWB-S1, -S2, -S3, -S4
- Gasket Option** for CWB-1, -2, -3, -4, -5, -6 or CWB-S1, -S2, -S3, -S4

Accessories

- Pan Support Bars:** 12" or 20"
- Stainless Steel Pans:**
 - Third-size
12¾"W x 6⅞"D x 2½"H
 - Half-size
12¾"W x 10⅞"D x 2½"H
 - Full-size at 2½" deep
12¾"W x 20¾"D x 2½"H
 - Full-size at 4" deep
12¾"W x 20¾"D x 4"H
 - Full-size at 6" deep
12¾"W x 20¾"D x 6"H
- Perforated False Bottom**

ACCESSORIES – PAGE 29

From below, you can see the condenser unit after being pulled out by the technician, allowing easy access and visibility to all service components



The sight glass gives an inside look into a usually closed system to determine if the refrigerant is low or if there is water in the system

REFRIGERATED DROP-IN WELLS COUNTERTOP CUT-OUTS

Model	Minimum Width	Maximum Width	Minimum Depth	Maximum Depth
CWB-1	17⅞"	18"	25⅞"	26"
CWB-2	30⅞"	31"	25⅞"	26"
CWB-3	43⅞"	44"	25⅞"	26"
CWB-4	56⅞"	57"	25⅞"	26"
CWB-5	69⅞"	70"	25⅞"	26"
CWB-6	82⅞"	83"	25⅞"	26"
Slim Series				
CWB-S1	25¼"	26⅞"	17⅞"	17⅞"
CWB-S2	46¼"	47⅞"	17⅞"	17⅞"
CWB-S3	67⅞"	68⅞"	17⅞"	17⅞"
CWB-S4	88⅞"	89¼"	17⅞"	17⅞"

The unique angled inside wall design provides easy access and clear views. The greater surface area of the angled wall and the placement of the coils allow cold air to more effectively blanket your food product.

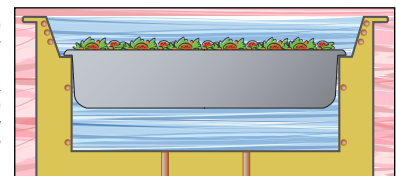

Refrigerated Drop-In Wells

Hatco's Refrigerated Drop-In Well is a full-size unit that blankets your pre-chilled food product to retain optimum freshness and taste in one efficient and easy operation – a winner for your foodservice operation.



CWB-6 with accessory food pans and pan support bars

- Full-size, insulated wells available in 1- to 6-pan configurations
- NSF 7 Component approved cold wall construction keeping food cold without drying it out
- Electronic control assembly can be mounted on either side of the condensing unit or remotely mounted up to 4 feet
- Adjustable condensing unit can be rotated 90° or 180° on all models for easy venting and flexibility at installation

- For the CWB-4, -5 or -6 models the mobile condensing unit can be mounted in several positions between the center of the well and the evaporator coil connections at installation
- Auto-defrost is activated through an advanced electronic controller programmed at the customer location
- Optimal insulation on sides and bottom to ensure better cold retention. Environmentally-friendly insulation used throughout
- Easy serviceability with a sight glass, service valves, dryer and a receiver. Long, flexible refrigerant line (ability to pull out condensing unit) for service
- 1" NPT (National Pipe Thread) brass drain simplifies cleaning

CWB-2 with slant option **CWB-2SLANT**



Quick-Ship Model pages 241-247

DROP-IN FULL-SIZE INSULATED RECTANGULAR WELLS

Model	Dimensions W x D x H	Voltage	HP and Watts @ 60 Hz			Ship Weight	List Price
			HP	Watts	Plug		
CWB-1	19" x 27" x 25½"	120	¼	300	NEMA 5-15P	133 lbs.	\$7122
CWB-2	32" x 27" x 25½"	120	¼	300	NEMA 5-15P	155 lbs.	7583
CWB-3	45" x 27" x 25½"	120	¼	300	NEMA 5-15P	173 lbs.	8133
CWB-4	58" x 27" x 25½"	120	½	450	NEMA 5-15P	211 lbs.	8717
CWB-5	71" x 27" x 25½"	120	¾	800	NEMA 5-15P	248 lbs.	9447
CWB-6	84" x 27" x 25½"	120	¾	800	NEMA 5-15P	292 lbs.	10022

All Refrigerated Drop-In Well Models Feature:

Voltage: Single phase.

Models Shipped with: Electronic temperature control, pan support bars for full-size pans, condensing unit (can be rotated), auto-defrost, sight glass, service valves and dryer. Consult factory for refrigerant specifications.

OPTIONS (available at time of purchase only)

EWC	Additional Four Year Parts Only Warranty on the Compressor	\$200
Slant Options –		
CWB-1SLANT	Slant Option for CWB-1	\$357
CWB-2SLANT	Slant Option for CWB-2	378
CWB-3SLANT	Slant Option for CWB-3	399
CWB-4SLANT	Slant Option for CWB-4	420
CWB-5SLANT	Slant Option for CWB-5	441
CWB-6SLANT	Slant Option for CWB-6	462
Gasket Options –		
BEZELGASKET-1	Factory installed for CWB-1	\$ 87
BEZELGASKET-2	Factory installed for CWB-2	87
BEZELGASKET-3	Factory installed for CWB-3	114
BEZELGASKET-4	Factory installed for CWB-4	114
BEZELGASKET-5	Factory installed for CWB-5	122
BEZELGASKET-6	Factory installed for CWB-6	122

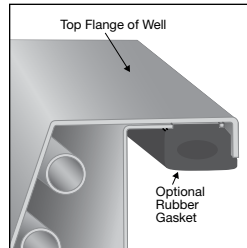

BEZELGASKET-1
Factory installed option (eliminates the need for silicone or other sealants)

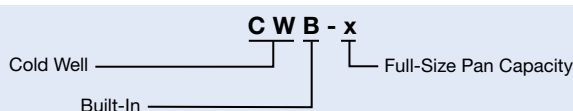
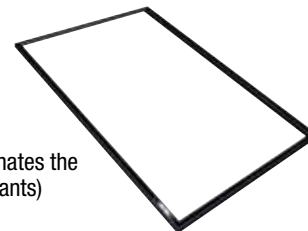
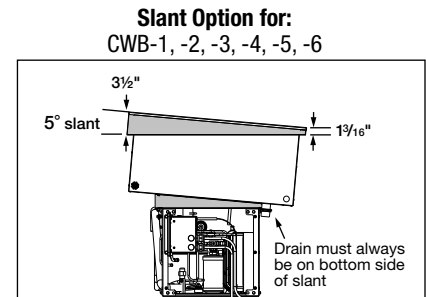

COUNTERTOP CUT-OUT DIMENSIONS – PAGE 23
ACCESSORIES – PAGE 29

Refrigerated Slim Drop-In Wells

Hatco's Refrigerated Slim Drop-In Well is a full-size unit that blankets your pre-chilled food product to retain optimum freshness and taste in one efficient and easy operation – but placed lengthwise. This provides customers with a complete cold well within easy reach, regardless of the sneeze guards.

- Insulated wells available in 1 to 4 full-size pan configurations
- NSF 7 Component approved cold wall construction keeping food product cold without drying it out
- Adjustable condensing unit can rotate 180° on all models for easy venting adjustments and flexibility at installation
- Mobile condensing unit can be moved in 4¹⁵/₁₆" increments from left end to center on the 2-, 3- and 4-pan units at installation (CWB-S1 is rotatable only)
- Easy serviceability with a sight glass, service valves, dryer/filter and a receiver. Long, flexible refrigerant line (ability to pull out condensing unit) for service
- Auto-defrost is activated through an advanced electronic controller programmed at customer location
- Optimal insulation on sides and bottom ensure better cold retention
- 1" NPT (National Pipe Thread) brass drain simplifies cleaning

CWB-S2 with accessory (hotel) food pans and additional pan support bars



CWB-S4 with optional slant kit, accessory (hotel) food pans and additional pan support bars

REFRIGERATED SLIM DROP-IN WELLS

Model	Dimensions W x D x H	HP and Watts @ 60 Hz			Ship Weight	List Price
		HP	Watts	Plug		
CWB-S1	27 ¹ / ₁₆ " x 19" x 33 ¹ / ₂ "	1/2	300	NEMA 5-15P	146 lbs.	\$ 7122
CWB-S2	48 ¹ / ₈ " x 19" x 26 ¹ / ₁₆ "	1/2	300	NEMA 5-15P	190 lbs.	7804
CWB-S3	69 ³ / ₁₆ " x 19" x 26 ¹ / ₁₆ "	1/2	450	NEMA 5-15P	221 lbs.	8999
CWB-S4	90 ¹ / ₄ " x 19" x 26 ¹ / ₁₆ "	3/4	800	NEMA 5-15P	283 lbs.	10825

All Refrigerated Slim Drop-In Well Models Feature:

Voltage: 120V, single phase.

Models Shipped with: Electronic temperature control, pan support bars for full-size pans, condensing unit (can be rotated 180°), auto-defrost, sight glass, service valves and dryer. Consult factory for refrigerant specifications.

Slant Option for:
CWB-S1, -S2, -S3, -S4

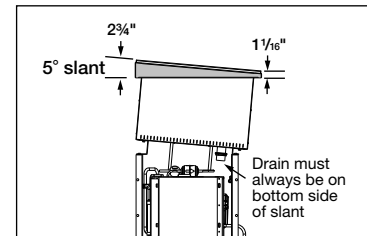

OPTIONS (available at time of purchase only)

EWC	Additional Four Year Parts Only Warranty on the Compressor	\$200
Slant Options –		
CWB-S1SLANT	Slant Option for CWB-S1	\$297
CWB-S2SLANT	Slant Option for CWB-S2	318
CWB-S3SLANT	Slant Option for CWB-S3	339
CWB-S4SLANT	Slant Option for CWB-S4	360
Gasket Options –		
BEZELGASKET-S1	Factory installed for CWB-S1	\$ 87
BEZELGASKET-S2	Factory installed for CWB-S2	87
BEZELGASKET-S3	Factory installed for CWB-S3	114
BEZELGASKET-S4	Factory installed for CWB-S4	114

COUNTERTOP CUT-OUT DIMENSIONS – PAGE 23 ACCESSORIES – PAGE 29

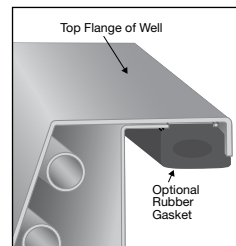

BEZELGASKET-S1
Factory installed option (eliminates the need for silicone or other sealants)

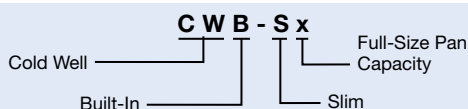

Remote Refrigerated Drop-In Wells Ordering Instructions

Wells

Cutaway of **CWBR-6** with accessory food pans

Cold Well with: Temperature Probe

NSF 7 Component approved cold wall construction, keeping food product cold without drying it out

A Refrigerated Well can house a variety of pans – full-size, half-size or third-size – showcasing a variety of your food products

The unique top bezel design also provides easy access and clear views

The greater surface area of the angled wall and the placement of the coils allow cold air to more effectively blanket your food product

Larger brass drain ensures easy cleaning
Exclusive flat screen design ensures that pans sit flush

Auto-defrost activated through an advanced electronic controller programmed at the customer location



CWBR: with a Condensing Unit
CWBX: without a Condensing Unit

The well cavity ensures energy efficiency with environmentally-friendly insulation used throughout

Please specify the following with each order:

- Number of Drop-In Wells Required:
 - Standard Configuration
1-, 2-, 3-, 4-, 5- or 6-pan as rectangular, full-size (12" x 20")
 - Slim configuration
S1-, S2-, S3- or S4-pan as rectangular, full-size (12" x 20") but placed lengthwise
- Depth of Model: Standard configuration (27"D) or Slim configuration (19"D)
- Remote Refrigeration
NOTE: Shipped loose: Cold Well with Temperature Probe, Control Panel (Probe Wires are 9') and a TXV Valve
 - CWBR with a Condensing Unit – may be field mounted up to 50' of tubing from the unit (shipped loose)
 - CWBX without a Condensing Unit (Solenoid Valve attached to Cold Well)
- Agency – UL, C-UL, NSF 7 Component (CWBR units UL, C-UL only)

Options

- Additional four year parts only warranty on the Compressor available at the time of unit purchase (CWBR only)
- Slant Option for CWBR- and CWBX-1, -2, -3, -4, -5, and -6 or -S1, -S2, -S3, -S4
- Gasket Option for CWBR- and CWBX-1, -2, -3, -4, -5, -6 or CWBR or CWBX-S1, -S2, -S3, -S4

Accessories

- Pan Support Bars: 12" or 20"

2. Stainless Steel Pans:

- Third-size at 2½" deep
12¾"W x 6⅞"D x 2½"H
- Half-size at 2½" deep
12¾"W x 10⅞"D x 2½"H
- Full-size at 2½" deep
12¾"W x 20¾"D x 2½"H
- Full-size at 4" deep
12¾"W x 20¾"D x 4"H
- Full-size at 6" deep
12¾"W x 20¾"D x 6"H

3. Perforated False Bottom

4. Trivets:

- Half-size
10⅜"W x 7⅞"D
- Full-size
10⅜"W x 18"D

ACCESSORIES – PAGE 29

REMOTE REFRIGERATED DROP-IN WELLS COUNTERTOP CUT-OUTS

Model	Minimum Width	Maximum Width	Minimum Depth	Maximum Depth
CWBR-1, CWBX-1	17⅞"	18"	25⅜"	26"
CWBR-2, CWBX-2	30⅞"	31"	25⅜"	26"
CWBR-3, CWBX-3	43⅞"	44"	25⅜"	26"
CWBR-4, CWBX-4	56⅞"	57"	25⅜"	26"
CWBR-5, CWBX-5	69⅞"	70"	25⅜"	26"
CWBR-6, CWBX-6	82⅞"	83"	25⅜"	26"
Slim Series				
CWBR-S1, CWBX-S1	25¼"	26⅞"	17⅞"	18"
CWBR-S2, CWBX-S2	46¼"	47⅞"	17⅞"	18"
CWBR-S3, CWBX-S3	67⅞"	68⅞"	17⅞"	18"
CWBR-S4, CWBX-S4	88⅞"	89¼"	17⅞"	18"



Remote Refrigerated Drop-In Wells

Hatco's Remote Refrigerated Drop-In Wells keep pre-chilled food products at safe-serving temperatures but in a remote configuration that offers unlimited flexibility for your own particular dining design needs.

- Full-size, insulated wells available in 1- to 6-pan configurations
- NSF 7 Component approved cold wall construction keeping food cold without drying it out
- Optimal insulation on sides and bottom to ensure better cold retention. Environmentally-friendly insulation used throughout
- CWBR models include a condensing unit (shipped loose, can be field mounted up to 50 feet of tubing from unit) and control panel (shipped loose - probe wires are 9 feet) for installing in more convenient or desirable locations
- CWBX model include a control panel (shipped loose - probe wires are 9 feet) but without a condensing unit for the increased flexibility of multiple cold well configurations
- Easy serviceability with a sight glass, service valves, dryer and a receiver (CWBR models only)
- Auto-defrost is activated through an advanced electronic controller programmed at the customer location
- 1" NPT (National Pipe Thread) brass drain simplifies cleaning



Control panel and a condensing unit (shipped loose)

CWBR-6 with accessory food pans and pan support bars



Control panel (shipped loose)

CWBX-6 with accessory food pans and pan support bars

REMOTE REFRIGERATED DROP-IN FULL-SIZE WELLS – WITH CONDENSING UNIT AND REMOTE CONTROL PANEL

Model	Dimensions W x D x H	HP	Hz	Ship Weight	List Price
CWBR-1	19" x 27" x 12"	1/5	60	131 lbs.	\$6375
CWBR-2	32" x 27" x 12"	1/5	60	160 lbs.	6836
CWBR-3	45" x 27" x 12"	1/5	60	213 lbs.	7386
CWBR-4	58" x 27" x 12"	1/5	60	200 lbs.	7970
CWBR-5	71" x 27" x 12"	5/8	60	271 lbs.	8700
CWBR-6	84" x 27" x 12"	5/8	60	313 lbs.	9275

All Remote Refrigerated Drop-In Well Models with Condensing Unit and Remote Control Panel Feature:

Voltage: CWBR-1, -2, -3: 120V, 300 watts, single phase.

CWBR-4: 120V, 450 watts, single phase.

CWBR-5, -6: 120V, 800 watts, single phase.

Models Shipped with: Electronic temperature control, condensing unit and TXV valve (all shipped loose). Consult factory for refrigerant specifications.

REMOTE REFRIGERATED DROP-IN FULL-SIZE WELLS – WITH REMOTE CONTROL PANEL

Model	Dimensions W x D x H	BTU/ Hour	Hz	Ship Weight	List Price
CWBX-1	19" x 27" x 17 1/16"	330	60	94 lbs.	\$5167
CWBX-2	32" x 27" x 17 1/16"	630	60	123 lbs.	5628
CWBX-3	45" x 27" x 17 1/16"	930	60	150 lbs.	6178
CWBX-4	58" x 27" x 17 1/16"	1230	60	176 lbs.	6762
CWBX-5	71" x 27" x 17 1/16"	1530	60	211 lbs.	7492
CWBX-6	84" x 27" x 17 1/16"	1830	60	250 lbs.	8067

All Remote Refrigerated Drop-In Well Models with Remote Control Panel Feature:

Voltage: 120V, single phase.

Models Shipped with: Electronic temperature control, TXV valve (shipped loose) and a solenoid valve attached to well.

COUNTERTOP CUT-OUT DIMENSIONS – PAGE 26 ACCESSORIES – PAGE 29

OPTIONS (available at time of purchase only)

EWC	Additional Four Year Parts Only Warranty on the Compressor (CWBR only)	\$200
Slant Options –		
CWBR-1SLANT	Slant Option for CWBR-1, CWBX-1	\$269
CWBR-2SLANT	Slant Option for CWBR-2, CWBX-2	290
CWBR-3SLANT	Slant Option for CWBR-3, CWBX-3	311
CWBR-4SLANT	Slant Option for CWBR-4, CWBX-4	332
CWBR-5SLANT	Slant Option for CWBR-5, CWBX-5	353
CWBR-6SLANT	Slant Option for CWBR-6, CWBX-6	374

Gasket Options –

BEZELGASKET-1	Factory installed for CWBR-1, CWBX-1	\$ 87
BEZELGASKET-2	Factory installed for CWBR-2, CWBX-2	87
BEZELGASKET-3	Factory installed for CWBR-3, CWBX-3	114
BEZELGASKET-4	Factory installed for CWBR-4, CWBX-4	114
BEZELGASKET-5	Factory installed for CWBR-5, CWBX-5	122
BEZELGASKET-6	Factory installed for CWBR-6, CWBX-6	122

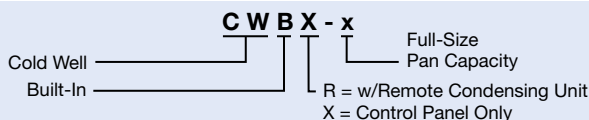

BEZELGASKET-1
Factory installed option (eliminates the need for silicone or other sealants)

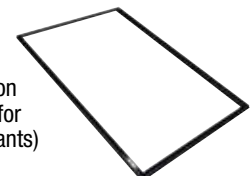

Remote Refrigerated Slim Drop-In Wells

Hatco's Remote Refrigerated Slim Drop-In Well is a full-size unit that blankets your pre-chilled food product to retain optimum freshness and taste in one efficient and easy operation – but placed lengthwise and in two remote configurations. This provides customers with a complete cold well within easy reach, regardless of the sneeze guards and unlimited flexibility for your design needs.

- Full-size, Insulated wells available in 1 to 4 full-size pan configurations
- NSF 7 Component approved cold wall construction keeping food product cold without drying it out
- Optimal insulation on sides and bottom to ensure better cold retention. Environmentally-friendly insulation used throughout
- CWBR-S models include a condensing unit (shipped loose, can be field mounted up to 50 feet of tubing from unit) and control panel (shipped loose - probe wires are 9 feet) for installing in more convenient or desirable locations
- CWBX-S model include a control panel (shipped loose - probe wires are 9 feet) but without a condensing unit for the increased flexibility of multiple cold well configurations
- Easy serviceability with a sight glass, service valves, dryer and a receiver (CWBR-S models only)
- Auto-defrost is activated through an advanced electronic controller programmed at customer location
- Optimal insulation on sides and bottom ensure better cold retention
- 1" NPT (National Pipe Thread) brass drain simplifies cleaning

Model **CWBR-S2** with accessory (hotel) food pans and additional support bars



Condensing unit (shipped loose)



Model **CWBX-S4** with accessory (hotel) food pans and additional support bars



Control panel (Shipped loose)

REMOTE REFRIGERATED SLIM DROP-IN FULL-SIZE WELLS – WITH CONDENSING UNIT AND REMOTE CONTROL PANEL

Model	Dimensions	HP	Watts	Ship Weight	List Price
	W x D x H				
CWBR-S1	27 ¹ / ₁₆ " x 19" x 12"	1/8	300	131 lbs.	\$6375
CWBR-S2	48 ¹ / ₈ " x 19" x 12"	1/8	300	162 lbs.	7057
CWBR-S3	69 ³ / ₁₆ " x 19" x 12"	1/8	450	213 lbs.	8252
CWBR-S4	90 ¹ / ₄ " x 19" x 12"	5/8	800	235 lbs.	10078

All Remote Refrigerated Slim Drop-In Well Models with Condensing Unit and Remote Control Panel Feature:

Voltage: 120V, single phase.

Models Shipped with: Electronic temperature control, condensing unit and TXV valve (all shipped loose). Consult factory for refrigerant specifications.

REMOTE REFRIGERATED SLIM DROP-IN FULL-SIZE WELLS – WITH REMOTE CONTROL PANEL

Model	Dimensions	Load/ BTU/H	Hz	Ship Weight	List Price
	W x D x H				
CWBX-S1	27 ¹ / ₁₆ " x 19" x 17 ¹ / ₈ "	330	60	94 lbs.	\$5167
CWBX-S2	48 ¹ / ₈ " x 19" x 17 ¹ / ₈ "	630	60	123 lbs.	5628
CWBX-S3	69 ³ / ₁₆ " x 19" x 17 ¹ / ₈ "	930	60	150 lbs.	6178
CWBX-S4	90 ¹ / ₄ " x 19" x 17 ¹ / ₈ "	1230	60	221 lbs.	6762

All Remote Refrigerated Slim Drop-In Well Models with Remote Control Panel Feature:

Voltage: 120V, single phase.

Models Shipped with: Electronic temperature control, TXV valve (all shipped loose) and a soleoid valve attached to the well.

OPTIONS (available at time of purchase only)

EWC	Additional Four Year Parts Only Warranty on the Compressor	\$200
Slant Options –		
CWB-S1SLANT	Slant Option for CWBR-S1 and CWBX-S1	297
CWB-S2SLANT	Slant Option for CWBR-S2 and CWBX-S2	318
CWB-S3SLANT	Slant Option for CWBR-S3 and CWBX-S3	339
CWB-S4SLANT	Slant Option for CWBR-S4 and CWBX-S4	359

Gasket Options –

BEZELGASKET-S1	Factory installed for CWBR-S1 and CWBX-S1	\$ 87
BEZELGASKET-S2	Factory installed for CWBR-S2 and CWBX-S2	87
BEZELGASKET-S3	Factory installed for CWBR-S3 and CWBX-S3	114
BEZELGASKET-S4	Factory installed for CWBR-S4 and CWBX-S4	114

COUNTERTOP CUT-OUT DIMENSIONS – PAGE 26 ACCESSORIES – PAGE 29

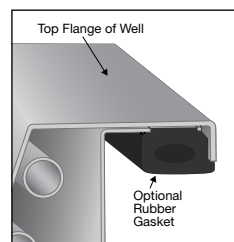
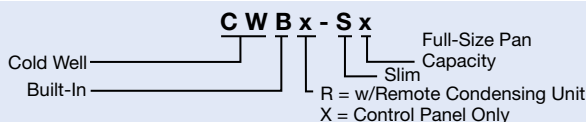

BEZELGASKET-S1
Factory installed option (eliminates the need for silicone or other sealants)



Refrigerated Drop-In Well Accessories *(available for purchase at any time)*



CWB-2 with optional CWB-2SLANT, and accessory food pans and pan support bars

Wells

PANS – TRIVETS *(available for purchase at any time)*

ST PAN 1/3	Third-Size Stainless Steel Pan – 12¾"W x 6⅞"D x 2½"H	\$ 64
ST PAN 1/2	Half-Size Stainless Steel Pan – 12¾"W x 10⅝"D x 2½"H	74
ST PAN 2	Full-Size Stainless Steel Pan – 12¾"W x 20¾"D x 2½"H	88
ST PAN 4	Full-Size Stainless Steel Pan – 12¾"W x 20¾"D x 4"H	110
HDW 6" PAN	Full-Size Stainless Steel Pan – 12¾"W x 20¾"D x 6"H	120
Wire Trivets Stainless –		
TRIVET (1/2)SS	Half-Size – 10⅞"W x 7⅞"D	\$119
TRIVET SS	Full-Size – 10⅞"W x 18"D	165

SUPPORT BARS – FALSE BOTTOMS *(available for purchase at any time)*

CWB12BAR	12" Pan Support Bar for Drop-In Ice or Refrigerated Wells	\$22
CWB20BAR	20" Pan Support Bar for Drop-In Ice or Refrigerated Wells	26

False Bottom for Drop-In Refrigerated Wells (Perforated False Bottom Accessory, choose your appropriate pan size) –

CWB-1FB	For CWB-1 Series (1-Part Accessory)	\$102
CWB-2FB	For CWB-2 Series (1-Part Accessory)	187
CWB-3FB	For CWB-3 Series (2-Part Accessory)	272
CWB-4FB	For CWB-4 Series (2-Part Accessory)	357
CWB-5FB	For CWB-5 Series (3-Part Accessory)	442
CWB-6FB	For CWB-6 Series (3-Part Accessory)	527

False Bottom for Slim Refrigerated Wells (choose your appropriate pan size) –

1FBS8	For CWB-S1 Series (1-Part Accessory)	\$102
2FBS8	For CWB-S2 Series (1-Part Accessory)	187
3FBS8	For CWB-S3 Series (2-Part Accessory)	272
4FBS8	For CWB-S4 Series (2-Part Accessory)	357

False Bottom Accessories

1-part, 2- or 3-part(s) depending on pan size

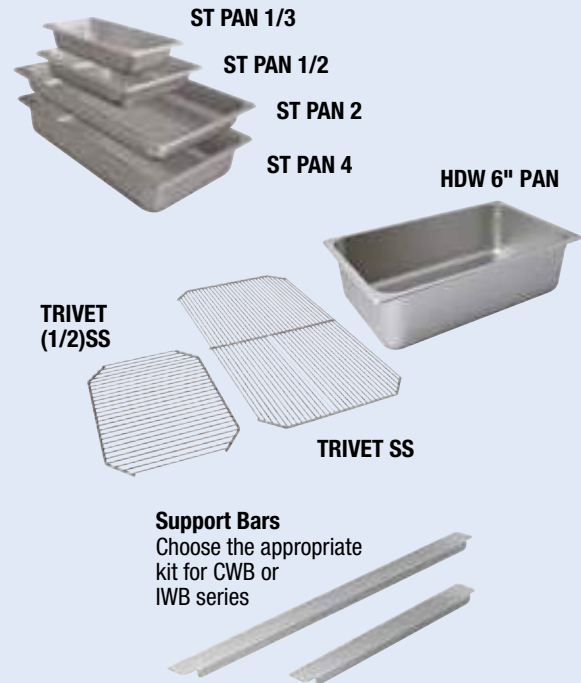
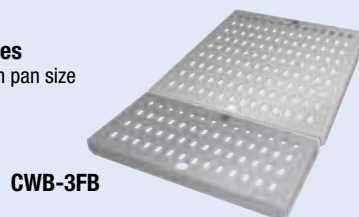

Support Bars
Choose the appropriate kit for CWB or IWB series

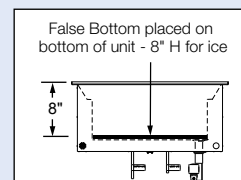

(CWB-1, -2, -3, -4, -5 or -6FB) for the CWB series

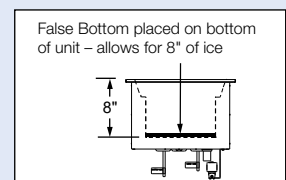

(1, 2, 3, or 4FBS8) for the CWB-S series

Drop-In Frost Top Ordering Instructions

Wells

Cutaway of **FTB-3**
with accessory sheet pans



NSF 7 Component approved, keeping food product cold without drying it out

1" NPT brass drain simplifies cleaning and flat drain strainer ensures pans set flush (not available on a one pan unit)

Recessed walls designed to prevent food pan slippage

Adjustable condensing unit can rotate 90° or 180° on all models for easy venting adjustments and flexible installation

Condensing unit may be moved in 6.5" increments from end to center in the FTB-3, FTB-S2, -S3 units, and in 3" increments from end to center in the FTB-2

Easy-to-service and removable

Auto-defrost activated through an advanced electronic controller programmed at the customer location

Environmentally-friendly insulation used throughout

Long, flexible refrigerant lines for easy pull-out and service

Please specify the following with each order:

1. Number of Full-Size Sheet Pans Accommodated:

1-, 2- or 3-pan as rectangular sheet pans with a Slim or Standard configuration

2. Depth of Model: Standard configuration (28¹⁵/₁₆"D) or Slim configuration (21¹⁵/₁₆"D)

3. Drain – 1" NPT Drain for FTB-2, FTB-3, FTB-S2, FTB-S3 only (drain plumbing to be installed per local codes)

4. Agency – UL, C-UL, NSF 7 Component

5. Electronic Control Assembly can be mounted on either side of the Condensing Unit or remotely mounted up to 4' from the unit (cannot be mounted over the Condensing Unit)

Option

- Additional four year parts only warranty on the Compressor available at the time of unit purchase

Accessories

- Pans –**
 - Half-size sheet pan 18"W x 13"D
 - Full-size sheet pan 18"W x 26"D

From below, you can see the condenser unit after being pulled out by the technician, allowing easy access and visibility to all service components



The sight glass gives an inside look into a usually closed system to determine if the refrigerant is low or if there is water in the system

DROP-IN FROST TOP COUNTERTOP CUT-OUTS

Model	Minimum Width	Maximum Width	Minimum Depth	Maximum Depth
FTB-1	19 ¹ / ₁₆ "	20 ⁷ / ₈ "	27 ¹ / ₁₆ "	28"
FTB-2	37 ³ / ₈ "	38"	27 ³ / ₁₆ "	28"
FTB-3	55 ³ / ₈ "	56"	27 ³ / ₁₆ "	28"
FTB-S2	53 ³ / ₁₆ "	54"	19 ¹ / ₁₆ "	20 ¹ / ₈ "
FTB-S3	79 ³ / ₁₆ "	79 ⁷ / ₈ "	19 ¹ / ₁₆ "	20 ¹ / ₈ "



Drop-In Frost Tops

Convenience meets style with the Hatco Drop-In Frost Tops. Perfect for quick turn products on self-serve buffets. Ideal for snacks, hors d'oeuvre, side dishes, desserts... truly a unit for breakfast, lunch and dinner. Sturdy construction and easy clean-up while keeping things cool. Also available in a slim configuration, providing wider access to your food product.

- Accommodates full-size sheet pans
- Units include a 1" NPT (National Pipe Thread) brass drain (excluding one pan units) and refrigeration system
- Electronic adjustable temperature control can be mounted to either side of the condensing unit or remotely up to four feet from unit
- The condensing unit, mounted on the center of the unit, rotates 90° or 180°
- Mobile condensing unit may be moved in 6½" increments from end to center in the FTB-3, FTB-S2, -S3 units, and in 3" increments from end to center in the FTB-2 at installation
- Optimal insulation on sides and bottom to ensure better cold retention, and built with one of the most efficient condensing units on the market
- Auto-defrost is activated through an advanced electronic controller programmed at the customer location

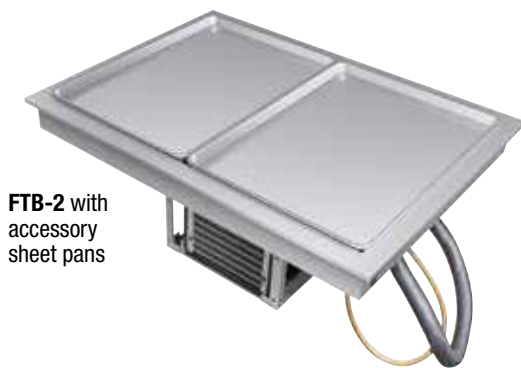

FTB-2 with accessory sheet pans



FTB-S2 with accessory sheet pans

DROP-IN FROST TOPS AND DROP-IN SLIM FROST TOPS

Model	Dimensions W x D x H	Drain (1" NPT Brass Drain)	HP	Hz	Watts	Plug	Ship Weight	List Price
FTB-1	21 ¹ / ₁₆ " x 28 ⁵ / ₁₆ " x 17 ¹ / ₄ "	None	1/5	60	300	NEMA 5-15P	132 lbs.	\$7278
FTB-2	39" x 28 ⁵ / ₁₆ " x 17 ¹ / ₄ "	Yes	1/5	60	300	NEMA 5-15P	170 lbs.	8103
FTB-3	57" x 28 ⁵ / ₁₆ " x 17 ¹ / ₄ "	Yes	1/5	60	300	NEMA 5-15P	213 lbs.	9029
Slim								
FTB-S2	54 ¹⁵ / ₁₆ " x 21 ¹ / ₁₆ " x 17 ¹ / ₄ "	Yes	1/5	60	300	NEMA 5-15P	182 lbs.	\$8186
FTB-S3	80 ³ / ₁₆ " x 21 ¹ / ₁₆ " x 17 ¹ / ₄ "	Yes	1/5	60	300	NEMA 5-15P	239 lbs.	9174

All Drop-In Frost Top Models Feature:

Voltage: 120V, single phase.

Models Shipped with: Electronic temperature control, condensing unit, compressor and flexible refrigerant lines to bottom of unit. Consult factory for refrigerant specifications.

OPTIONS (available at time of purchase only)

EWC	Additional Four Year Parts Only Warranty on the Compressor Available at the Time of Unit Purchase	\$200
------------	---	--------------

ACCESSORIES (available for purchase at any time)

ALUM PAN	Half-Size Sheet Pan – 18"W x 13"D	\$35
18" SHEET PAN	Full-Size Sheet Pan – 18"W x 26"D	49

COUNTERTOP CUT-OUT DIMENSIONS – PAGE 30

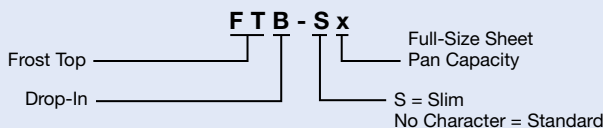

Remote Drop-In Frost Top Ordering Instructions

Wells

Cutaway of **FTBR-3**
with accessory sheet pans

Frost Top with:
Temperature Probe

1" NPT brass drain
simplifies cleaning and
flat drain strainer ensures
pans sit flush (not available
on a one pan unit)

Recessed walls designed to
prevent food pan slippage

Control Panel



Auto-defrost activated
through an advanced
electronic controller
programmed at the
customer location



FTBR: Condensing Unit
FTBX: No Condensing Unit

Environmentally-
friendly insulation
used throughout

NSF 7 Component approved cold
wall construction keeps food product
cold without drying it out

Please specify the following with each order:

- Number of Full-Size Sheet Pans Accommodated:**
1-, 2- or 3-pan as rectangular sheet pans
- Depth of Model:** Standard configuration (28¹⁵/₁₆"D)
or Slim configuration (21¹/₁₆"D)
- Remote Refrigeration**
Note: Shipped loose: Frost Top, Control Panel
(Probe Wires are 9') and a TXV Valve
A. FTBX without a Condensing Unit
(Solenoid Valve attached to Frost Top)
- Agency** – UL, C-UL, NSF 7 Component

Accessories

- Pans** –
A. Half-size sheet pan
18"W x 13"D
B. Full-size sheet pan
18"W x 26"D

REMOTE DROP-IN FROST TOP COUNTERTOP CUT-OUTS

Model	Minimum Width	Maximum Width	Minimum Depth	Maximum Depth
FTBR-1, FTBX-1	27 ⁷ / ₁₆ "	28"	19 ⁷ / ₁₆ "	20 ¹ / ₈ "
FTBR-2, FTBX-2	37 ³ / ₈ "	38"	27 ⁷ / ₁₆ "	28"
FTBR-3, FTBX-3	55 ⁵ / ₁₆ "	56"	27 ⁷ / ₁₆ "	28"
FTBR-S2, FTBX-S2	53 ⁵ / ₁₆ "	54"	19 ⁷ / ₁₆ "	20 ¹ / ₈ "
FTBR-S3, FTBX-S3	79 ¹ / ₁₆ "	79 ¹ / ₁₆ "	19 ⁷ / ₁₆ "	20 ¹ / ₈ "



Remote Drop-In Frost Tops

Keeping pre-chilled beverages, snacks, hors d'oeuvres and side dishes cool and ready-to-serve, the Hatco Remote Drop-In Frost Tops offer additional flexibility with remote configurations. Also available in a Slim configuration, providing wider access to your customer.

- Accommodates full-size sheet pans
- Units include a 1" NPT (National Pipe Thread) brass drain (excluding one pan units)
- FTBR models include a condensing unit (shipped loose, can be field mounted up to 50 feet of tubing from unit) and a control panel (shipped loose - probe wires are 9 feet) for installing in more convenient or desirable locations
- FTBX models include a control panel (shipped loose - probe wires are 9 feet) but shipped without a condensing unit for the increased flexibility of multiple Frost Top configurations
- Easy serviceability with a sight glass, service valves, dryer and a receiver (FTBR models only)
- Auto-defrost is activated through an advanced electronic controller programmed at the customer location (FTBR models only)
- Optimal insulation on sides and bottom to ensure better cold retention, and built with one of the most efficient condensing units on the market

FTBR-S2
with accessory
sheet pans



Frost Top with a
temperature
probe, control
panel and
a condensing
unit (both
shipped loose)

FTBX-1 (shipped
without condensing unit)

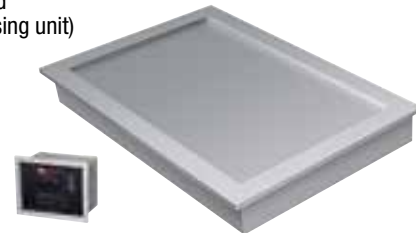

Control panel
(shipped loose)

REMOTE DROP-IN FROST TOPS – WITH CONDENSING UNIT AND CONTROL PANEL

Model	Dimensions W x D x H	HP	Ship Weight	List Price
FTBR-1*	28 ¹⁵ / ₁₆ " x 21 ¹ / ₁₆ " x 8 ⁵ / ₈ "	1/5	125 lbs.	\$6531
FTBR-2	39" x 28 ¹⁵ / ₁₆ " x 8 ⁵ / ₈ "	1/5	151 lbs.	7356
FTBR-3	57" x 28 ¹⁵ / ₁₆ " x 8 ⁵ / ₈ "	1/5	213 lbs.	8282
Slim				
FTBR-S2	54 ¹⁵ / ₁₆ " x 21 ¹ / ₁₆ " x 8 ⁵ / ₈ "	1/5	179 lbs.	\$7439
FTBR-S3	80 ¹³ / ₁₆ " x 21 ¹ / ₁₆ " x 8 ⁵ / ₈ "	1/5	230 lbs.	8427

* No drain

All Remote Drop-In Frost Top Models Feature:

Voltage – FTBR-1, -2, -3, -S2, -S3: 120V, 300 watts, 60 Hz, single phase.

Models Shipped with: Electronic temperature control, condensing unit and TXV valve (all shipped loose). Consult factory for refrigerant specifications.

REMOTE DROP-IN FROST TOPS – WITH CONTROL PANEL

Model	Dimensions W x D x H	BTU/ Hour	Ship Weight	List Price
FTBX-1	28 ¹⁵ / ₁₆ " x 21 ¹ / ₁₆ " x 8 ⁵ / ₈ "	330	85 lbs.	\$5323
FTBX-2	39" x 28 ¹⁵ / ₁₆ " x 8 ⁵ / ₈ "	630	138 lbs.	6148
FTBX-3	57" x 28 ¹⁵ / ₁₆ " x 8 ⁵ / ₈ "	930	220 lbs.	7074
Slim				
FTBX-S2	54 ¹⁵ / ₁₆ " x 21 ¹ / ₁₆ " x 8 ⁵ / ₈ "	630	130 lbs.	\$6231
FTBX-S3	80 ¹³ / ₁₆ " x 21 ¹ / ₁₆ " x 8 ⁵ / ₈ "	930	182 lbs.	7219

All Remote Drop-In Frost Top Models Feature:

Voltage: 120, single phase.

Models Shipped with: Electronic temperature control, TXV valve (shipped loose) and a solenoid valve attached to well.

OPTIONS (available at time of purchase only)

EWC	Additional Four Year Extended Parts Only Warranty on the Compressor (FTBR only)	\$200
------------	---	--------------

ACCESSORIES (available for purchase at any time)

ALUM PAN	Half-Size Sheet Pan – 18"W x 13"D	\$35
18" SHEET PAN	Full-Size Sheet Pan – 18"W x 26"D	49

COUNTERTOP CUT-OUT DIMENSIONS – PAGE 32

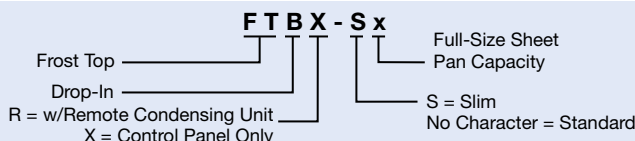

Modular/Ganged Heated Wells (Full and 4/3-Size) Ordering Instructions

Cutaway of **HWBI-5MA** with accessory food pans and optional split control boxes

Wells

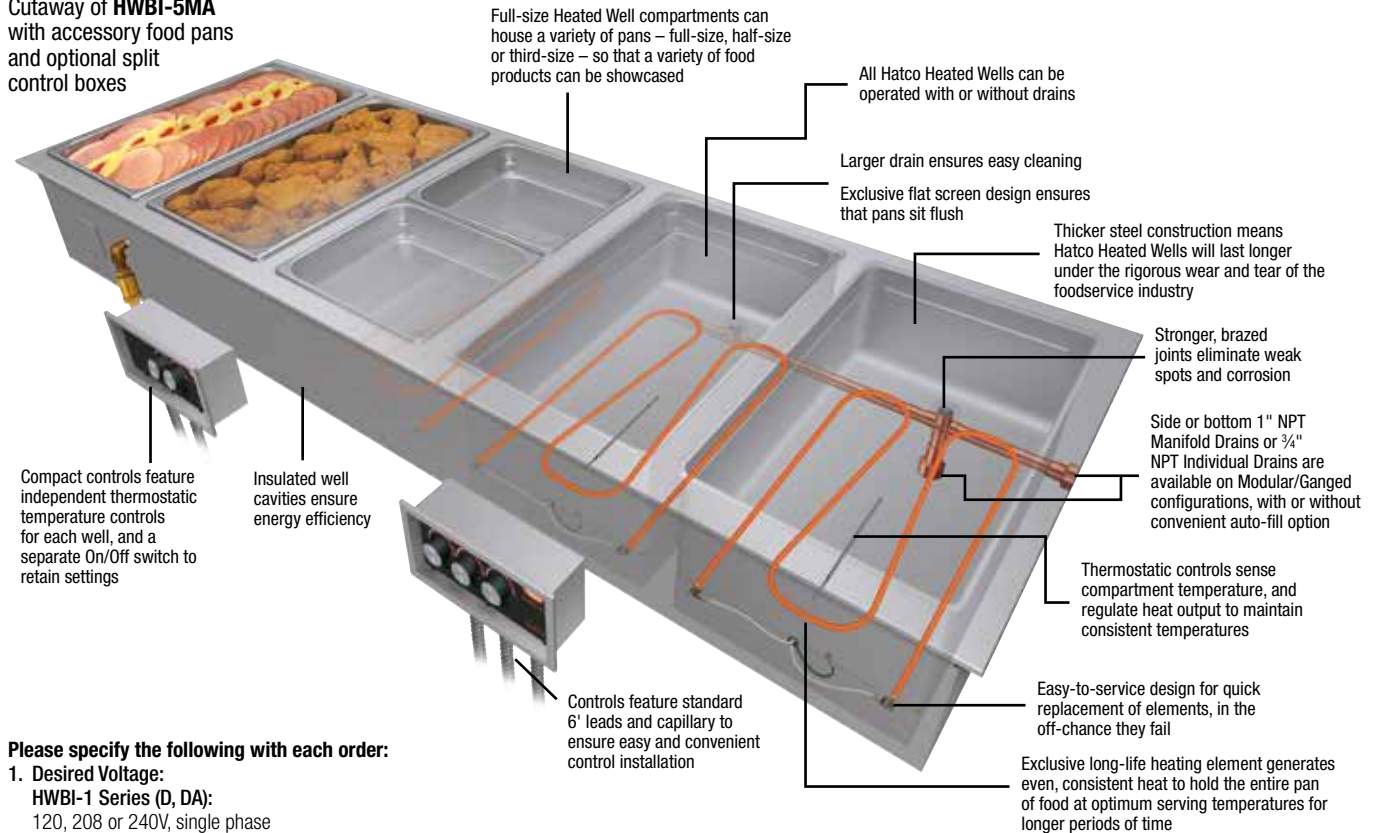

Please specify the following with each order:

- Desired Voltage:**
 - HWBI-1 Series (D, DA):** 120, 208 or 240V, single phase
 - HWBLI-1, -2, -3, -4, -5, -6 Series (D, DA, M, MA):** 120V, single phase
 - HWBI-2, -3, -4, -5, -6 Series (D, DA, M, MA):** 208 or 240V, single or optional three phase
 - HWBI43-1 (D, DA):** 120, 208 or 240V, single phase
 - HWBI43-2, -3, -6 Series (D, DA, M, MA):** 208 or 240V, single or optional three phase
 - HWBI43-4, -5 Series (D, DA, M, MA):** 240V, single or optional three phase
- Desired Wattage:**
 - A. Standard Watt
 - B. Low Watt (120V only) and not available for HWBI43 Series)
- Number of Modular/Ganged Heated Wells Required:**
 - 1-, 2-, 3-, 4-, 5- or 6-pan
 - NOTE:** Modular/Ganged units are only offered as rectangular, full-size (12" x 20") as 4/3-size wells (12" x 27")
- Drain (with or without – choose drain below):**
 - A. Standard Individual Well 3/4" NPT Drain
 - B. Manifold 1" NPT Drain with side drain, field selectable left or right side (available on HWBI- or HWBLI-2, -3, -4, -5, -6 models only)
 - C. Manifold 1" NPT Drain with bottom drain, field selectable left or right well (available on HWBI- or HWBLI-2, -3, -4, -5, -6 models only)
- Auto-fill (with or without)**
- Bezel** allows a 27" depth for modular units to match Hatco CWB models in a countertop display (not available for HWBI43 Series)
- Agency:**
 - A. UL, C-UL
 - B. UL-EPH (sanitary listing)
- Control:**
 - A. Single Control Box (standard on all units)
 - B. Split Controls Boxes (optional on 4-, 5-, 6-pan units, not available in Canada)

Accessories for Modular/Ganged Heated Wells

- Pan Support Bars:**
 - A. Standard or Slim configuration 12" or 20"
 - B. 4/3-size configuration 12"
- Adapters** to convert Modular/Ganged units to hold 4- or 7-quart round pans
- Stainless Steel Pans:**
 - A. Third-size (12 3/4"W x 6 7/8"D x 2 1/2"H)
 - B. Half-size (12 3/4"W x 10 3/8"D x 2 1/2"H)
 - C. Full-size at 2 1/2" deep (12 3/4"W x 20 3/4"D x 2 1/2"H)
 - D. Full-size at 4" deep (12 3/4"W x 20 3/4"D x 4"H)
 - E. Full-size at 6" deep (12 3/4"W x 20 3/4"D x 6"H)
- Valves:**
 - A. 3/4" or 1" NPT Ball Valve
 - B. 3/4" or 1" NPT Gate Valve
- Heated Well Covers** to convert Modular/Ganged units to heated shelves (not available for HWBI43 Series):
 - A. 1-Pan Heated Well Cover
 - B. 2-Pan Heated Well Cover

DROP-IN MODULAR/GANGED HEATED WELLS COUNTERTOP CUT-OUTS

Model	Minimum Width	Maximum Width	Minimum Depth	Maximum Depth
HWBI-, HWBLI-1 Series	14 1/8"	14 1/2"	22 1/4"	22 5/8"
HWBI-, HWBLI-2 Series	28 3/8"	28 3/2"	22 1/4"	22 5/8"
HWBI-, HWBLI-3 Series	42 1/8"	42 1/2"	22 1/4"	22 5/8"
HWBI-, HWBLI-4 Series	56 1/8"	56 1/2"	22 1/4"	22 5/8"
HWBI-, HWBLI-5 Series	70 1/8"	70 1/2"	22 1/4"	22 5/8"
HWBI-, HWBLI-6 Series	84 1/8"	84 1/2"	22 1/4"	22 5/8"
4/3-Size				
HWBI43-1 Series	14 3/16"	14 3/8"	29 1/8"	29 3/8"
HWBI43-2 Series	28 3/16"	28 3/8"	29 1/8"	29 3/8"
HWBI43-3 Series	42 3/16"	42 3/8"	29 1/8"	29 3/8"
HWBI43-4 Series	56 3/16"	56 3/8"	29 1/8"	29 3/8"
HWBI43-5 Series	70 3/16"	70 3/8"	29 1/8"	29 3/8"
HWBI43-6 Series	84 3/16"	84 3/8"	29 1/8"	29 3/8"

ACCESSORIES – PAGES 40, 51-52



From the top, the modular design allows the Modular/Ganged Heated Well to appear as one integrated unit. From below, you will see separate covers, with easy, independent access to each one. This makes installation and service easy

Modular/Ganged Heated Wells

Hatco Modular/Ganged Heated Wells are full-size units that are grouped together in a modular fashion to provide customers with a complete steam table contained within one piece of equipment for a clean, integrated look.

- Full-size, insulated wells available in 1- to 6-ganged units in either standard or low wattages
- Individual thermostatic controls for each well provide the ultimate in temperature regulation
- 6" conduit is standard for convenient placement of controls
- Wells empty quickly and easily with a manifold drain option
- Auto-fill option to automatically fill and replenish water without user maintenance and intervention
- Separate well assemblies with independent access to each one for easy service

HWBLI-5MA with accessory food pans and standard single control box



LOW WATT DROP-IN MODULAR/GANGED FULL-SIZE RECTANGULAR WELLS – INSULATED – TOP MOUNT

Model	Dimensions (W x D x H)	Watts	Ship Weight	List Price
HWBLI-1	15½" x 23¾" x 9⅝"	750	38 lbs.	\$1395
HWBLI-1D	15½" x 23¾" x 9⅝"	750	36 lbs.	1502
HWBLI-1DA	15½" x 23¾" x 9⅝"	750	38 lbs.	2123
HWBLI-2	29½" x 23¾" x 9⅝"	1500	82 lbs.	2950
HWBLI-2D	29½" x 23¾" x 9⅝"	1500	85 lbs.	3103
HWBLI-2DA*	29½" x 23¾" x 9⅝"	1500	87 lbs.	3708
HWBLI-2M	29½" x 23¾" x 9⅝"	1500	84 lbs.	3173
HWBLI-2MA	29½" x 23¾" x 9⅝"	1500	85 lbs.	3981
HWBLI-3	43½" x 23¾" x 9⅝"	2250	106 lbs.	3681
HWBLI-3D	43½" x 23¾" x 9⅝"	2250	110 lbs.	3956
HWBLI-3DA*	43½" x 23¾" x 9⅝"	2250	114 lbs.	4254
HWBLI-3M	43½" x 23¾" x 9⅝"	2250	105 lbs.	4206
HWBLI-3MA	43½" x 23¾" x 9⅝"	2250	124 lbs.	5014
HWBLI-4	57½" x 23¾" x 9⅝"	3000	134 lbs.	4774
HWBLI-4D	57½" x 23¾" x 9⅝"	3000	155 lbs.	5270
HWBLI-4DA*	57½" x 23¾" x 9⅝"	3000	133 lbs.	5874
HWBLI-4M	57½" x 23¾" x 9⅝"	3000	148 lbs.	5688
HWBLI-4MA	57½" x 23¾" x 9⅝"	3000	141 lbs.	6496
HWBLI-5	71½" x 23¾" x 9⅝"	3750	167 lbs.	5724
HWBLI-5D	71½" x 23¾" x 9⅝"	3750	166 lbs.	6561
HWBLI-5DA*	71½" x 23¾" x 9⅝"	3750	167 lbs.	7181
HWBLI-5M	71½" x 23¾" x 9⅝"	3750	188 lbs.	7109
HWBLI-5MA	71½" x 23¾" x 9⅝"	3750	193 lbs.	7896
HWBLI-6	85½" x 23¾" x 9⅝"	4500	194 lbs.	7415
HWBLI-6D	85½" x 23¾" x 9⅝"	4500	203 lbs.	8080
HWBLI-6DA*	85½" x 23¾" x 9⅝"	4500	200 lbs.	8658
HWBLI-6M	85½" x 23¾" x 9⅝"	4500	200 lbs.	8831
HWBLI-6MA	85½" x 23¾" x 9⅝"	4500	200 lbs.	9598

* Auto-fill located on left control only and fills left-hand well. To fill all wells, drains must be connected with external manifold by installer.

All Low Watt Drop-In Modular/Ganged Full-Size Rectangular Heated Well Models Feature:

Voltage: HWBLI-1DA, 2, -3, -4, -5, -6 Series: 120V, single phase.

Models Shipped with: EZ locking hardware for installation and remote thermostats with flexible conduits and lighted power switches.

Modular/Ganged Heated Wells Controls*

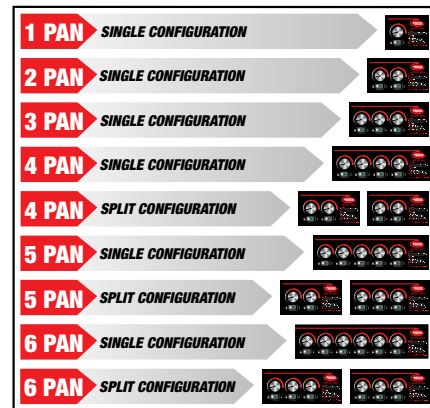

*4-, 5-, 6-pan units: Single control box is standard. If optional split control boxes are desired, it must be specified at order (for Canada, split control boxes not available).

OPTIONS (available at time of purchase only)

HWBI-SIDE	Copper Manifold Drain with side exit (not available on HWBLI-1)	No Charge
HWBI-BOTTOM	Copper Manifold Drain with bottom exit (not available on HWBLI-1)	No Charge
HWBLI-CORD-2	Cord for HWBLI-2 (single phase)	\$103
HWBLI-CORD-3	Cord for HWBLI-3 (single phase)	188
OS-BEZEL27	27" deep Bezel for Modular unit to match Hatco CWB in a countertop display	No Charge
COND-3	36" Flexible Conduit in lieu of 72" standard (For split control panel only)	No Charge

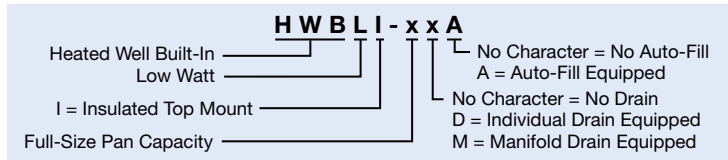

COUNTERTOP CUT-OUT DIMENSIONS – PAGE 34
ACCESSORIES – PAGES 40, 51-52

Modular/Ganged Heated Wells - Continued

Wells

HWBI-3MA with accessory food pans and optional cord for HWBI-3



STANDARD WATT DROP-IN MODULAR/GANGED FULL-SIZE RECTANGULAR WELLS – INSULATED – TOP MOUNT

Model	Dimensions W x D x H	Watts	Ship Weight	List Price
HWBI-1	15½" x 23¾" x 9⅞"	1215	34 lbs.	\$1395
HWBI-1D	15½" x 23¾" x 9⅞"	1215	38 lbs.	1502
HWBI-1DA	15½" x 23¾" x 9⅞"	1215	38 lbs.	2123
HWBI-2	29½" x 23¾" x 9⅞"	2415	73 lbs.	2950
HWBI-2D	29½" x 23¾" x 9⅞"	2415	77 lbs.	3103
HWBI-2DA*	29½" x 23¾" x 9⅞"	2415	87 lbs.	3708
HWBI-2M	29½" x 23¾" x 9⅞"	2415	74 lbs.	3173
HWBI-2MA	29½" x 23¾" x 9⅞"	2415	85 lbs.	3981
HWBI-3	43½" x 23¾" x 9⅞"	3615	103 lbs.	3681
HWBI-3D	43½" x 23¾" x 9⅞"	3615	114 lbs.	3956
HWBI-3DA*	43½" x 23¾" x 9⅞"	3615	114 lbs.	4254
HWBI-3M	43½" x 23¾" x 9⅞"	3615	108 lbs.	4206
HWBI-3MA	43½" x 23¾" x 9⅞"	3615	112 lbs.	5014
HWBI-4	57½" x 23¾" x 9⅞"	4815	132 lbs.	4774
HWBI-4D	57½" x 23¾" x 9⅞"	4815	136 lbs.	5270
HWBI-4DA*	57½" x 23¾" x 9⅞"	4815	133 lbs.	5874
HWBI-4M	57½" x 23¾" x 9⅞"	4815	138 lbs.	5688
HWBI-4MA	57½" x 23¾" x 9⅞"	4815	138 lbs.	6496
HWBI-5	71½" x 23¾" x 9⅞"	6015	167 lbs.	5724
HWBI-5D	71½" x 23¾" x 9⅞"	6015	167 lbs.	6561
HWBI-5DA*	71½" x 23¾" x 9⅞"	6015	167 lbs.	7181
HWBI-5M	71½" x 23¾" x 9⅞"	6015	167 lbs.	7109
HWBI-5MA	71½" x 23¾" x 9⅞"	6015	184 lbs.	7896
HWBI-6	85½" x 23¾" x 9⅞"	7215	189 lbs.	7415
HWBI-6D	85½" x 23¾" x 9⅞"	7215	189 lbs.	8080
HWBI-6DA*	85½" x 23¾" x 9⅞"	7215	193 lbs.	8658
HWBI-6M	85½" x 23¾" x 9⅞"	7215	189 lbs.	8831
HWBI-6MA	85½" x 23¾" x 9⅞"	7215	195 lbs.	9598

* Auto-fill located on left control only and fills left-hand well. To fill all wells, drains must be connected with external manifold by installer.

All Standard Watt Drop-In Modular/Ganged

Full-Size Rectangular Heated Well Models Feature:

Voltage: HWBI-1 Series: 120, 208 or 240V, single phase.

HWBI-2, -3, -4, -5, -6 Series: 208 or 240V, single phase or optional three phase.

Models Shipped with: EZ locking hardware for installation and remote thermostats with 6' flexible conduits and lighted power switches.

Modular/Ganged Heated Wells Controls*

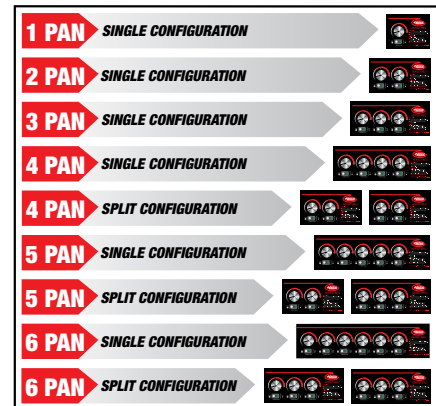

*4-, 5-, 6-pan units: Single control box is standard. If optional split control boxes are desired, it must be specified at order (for Canada, split control boxes not available).

DROP-IN MODULAR/GANGED 3 Ø AMP RATINGS

Model	208V/3 Ø Amps	240V/3 Ø Amps
HWBI-2	10.1	8.7
HWBI-3	10.1	8.8
HWBI-4	15.8	13.7
HWBI-5	20.1	17.4
HWBI-6	20.1	17.4

OPTIONS (available at time of purchase only)

HWBI-3PH	Three-Phase Wiring (not available on HWBI-1 series)	No Charge
HWBI-SIDE	Copper Manifold Drain with side exit (not available on HWBI-1)	No Charge
HWBI-BOTTOM	Copper Manifold Drain with bottom exit (not available on HWBI-1)	No Charge
HWBI-CORD-1, -2	Cord for HWBI-1, -2 (single phase)	\$103
HWBI-CORD-3, -4	Cord for HWBI-3, -4 (single phase/single control box only)	188
HWBI-CORD-5, -6	Cord for HWBI-5, -6 (single phase/single control box only)	362
OS-BEZEL27	27" deep Bezel for Modular unit to match Hatco CWB in a countertop display	No Charge
COND-3	36" Flexible Conduit in lieu of 72" standard (For split control panel only)	No Charge

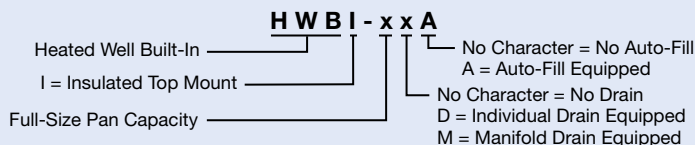

COUNTERTOP CUT-OUT DIMENSIONS – PAGE 34
ACCESSORIES – PAGES 40, 51-52

Drop-In Modular/ Ganged 4/3-Size Heated Wells

Hatco Modular/Ganged 4/3-Size Heated Wells maintain hot food at safe-serving temperatures, with better quality construction, longer holding times and more accurate temperatures. A deeper single unit can hold the equivalent of 4 third-size pans.

Choose the number of wells, from 1 to 6 unit configurations, as well as voltage, auto-fill, controls and drain options. Each well has its own individual control to regulate the temperature of each food offering.

- Longer holding times with more accurate temperatures
- Separate lighted On/Off rocker switch and temperature dial for easy operation

- 50% larger drain with flat screen simplifies cleaning and holds pans level
- Unique design allows quick change of element or thermostat if needed
- EZ locking hardware for quick installation
- Stainless steel construction and solid brazed drain fitting joints for durability
- A 6' (1829 mm) conduit is included for convenient placement of controls

DROP-IN MODULAR/GANGED 4/3-SIZE RECTANGULAR WELLS – INSULATED – TOP MOUNT

Model	Dimensions W x D x H	Voltage	Watts	Ship Weight	List Price
HWBI43-1	15½" x 30¾" x 9¾"	208 or 240	1215	42 lbs.	\$ 1967
HWBI43-1D	15½" x 30¾" x 9¾"	208 or 240	1215	42 lbs.	2025
HWBI43-1DA	15½" x 30¾" x 9¾"	208 or 240	1215	47 lbs.	2752
HWBI43-2	29½" x 30¾" x 9¾"	208 or 240	2415	88 lbs.	3281
HWBI43-2D	29½" x 30¾" x 9¾"	208 or 240	2415	96 lbs.	3402
HWBI43-2DA*	29½" x 30¾" x 9¾"	208 or 240	2415	95 lbs.	4157
HWBI43-2M	29½" x 30¾" x 9¾"	208 or 240	2415	82 lbs.	3731
HWBI43-2MA	29½" x 30¾" x 9¾"	208 or 240	2415	98 lbs.	4487
HWBI43-3	43½" x 30¾" x 9¾"	208 or 240	3615	115 lbs.	4480
HWBI43-3D	43½" x 30¾" x 9¾"	208 or 240	3615	112 lbs.	4658
HWBI43-3DA*	43½" x 30¾" x 9¾"	208 or 240	3615	124 lbs.	5391
HWBI43-3M	43½" x 30¾" x 9¾"	208 or 240	3615	135 lbs.	5035
HWBI43-3MA	43½" x 30¾" x 9¾"	208 or 240	3615	135 lbs.	5771
HWBI43-4	57½" x 30¾" x 9¾"	208 or 240	4815	166 lbs.	5902
HWBI43-4D	57½" x 30¾" x 9¾"	208 or 240	4815	152 lbs.	6139
HWBI43-4DA*	57½" x 30¾" x 9¾"	208 or 240	4815	149 lbs.	6874
HWBI43-4M	57½" x 30¾" x 9¾"	208 or 240	4815	154 lbs.	6565
HWBI43-4MA	57½" x 30¾" x 9¾"	208 or 240	4815	180 lbs.	7300
HWBI43-5	71½" x 30¾" x 9¾"	208 or 240	6015	197 lbs.	7191
HWBI43-5D	71½" x 30¾" x 9¾"	208 or 240	6015	186 lbs.	7498
HWBI43-5DA*	71½" x 30¾" x 9¾"	208 or 240	6015	187 lbs.	8255
HWBI43-5M	71½" x 30¾" x 9¾"	208 or 240	6015	186 lbs.	7984
HWBI43-5MA	71½" x 30¾" x 9¾"	208 or 240	6015	203 lbs.	8741
HWBI43-6	85½" x 30¾" x 9¾"	208 or 240	7215	214 lbs.	8587
HWBI43-6D	85½" x 30¾" x 9¾"	208 or 240	7215	214 lbs.	8977
HWBI43-6DA*	85½" x 30¾" x 9¾"	208 or 240	7215	217 lbs.	9767
HWBI43-6M	85½" x 30¾" x 9¾"	208 or 240	7215	214 lbs.	9606
HWBI43-6MA	85½" x 30¾" x 9¾"	208 or 240	7215	249 lbs.	10390

* Auto-fill located on left control only and fills left-hand well. To fill all wells, drains must be connected with external manifold by installer.

All Drop-In Modular/Ganged 4/3-Size Rectangular Heated Well Models Feature:

Phase: HWBI43-1 Series: Single only. HWBI43-2, -3, -4, -5, -6 Series: Single or optional three phase.

Models Shipped with: EZ locking hardware for installation and remote thermostats with 72" flexible conduits and lighted power switches.



HWBI43-3DA with
- 4 third-size pans,
- 2 half-size pans and 1 third-size pan
- 1 full-size pan and
1 third-size pan

Modular/Ganged Heated Wells Controls*

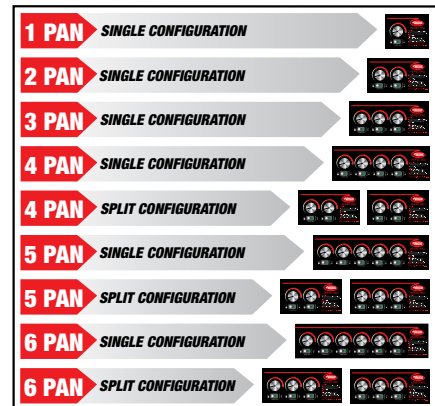

* 4-, 5-, 6-pan units: Single control box is standard. If optional split control boxes are desired, it must be specified at order (for Canada, split control boxes not available).

OPTIONS (available at time of purchase only)

HWBI-3PH	Three-Phase Wiring (not available on HWBI43-1 series)	No Charge
HWBI-SIDE	Copper Manifold Drain with side exit (not available on HWBI43-1)	No Charge
HWBI-BOTTOM	Copper Manifold Drain with bottom exit (not available on HWBI43-1)	No Charge
HWBI43-CORD-1, -2	Cord for HWBI43-1, -2 (single phase)	\$103
HWBI43-CORD-3, -4	Cord for HWBI43-3, -4 (single phase/single control box only)	188
HWBI43-CORD-5, -6	Cord for HWBI43-5, -6 (single phase/single control box only)	362
COND-3	36" Flexible Conduit in lieu of 72" standard (For split control panel only)	No Charge

HWBI43 - x x A

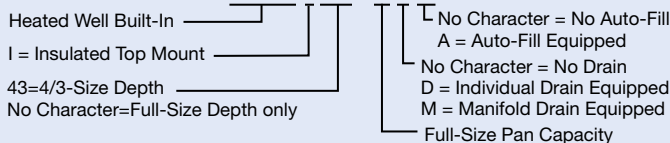

DROP-IN MODULAR/GANGED 4/3-SIZE 3 Ø AMP RATINGS

Model	208V/3 Ø Amps	240V/3 Ø Amps
HWBI43-2	10.1	8.7
HWBI43-3	10.1	8.8
HWBI43-4	-	13.7
HWBI43-5	-	17.4
HWBI43-6	20.1	17.4

COUNTERTOP CUT-OUT DIMENSIONS – PAGE 34
ACCESSORIES – PAGES 40, 51-52

Modular/Ganged Slim Heated Wells Ordering Instructions

Wells

Cutaway of **HWBI-S4MA** with accessory food pans and standard single controls

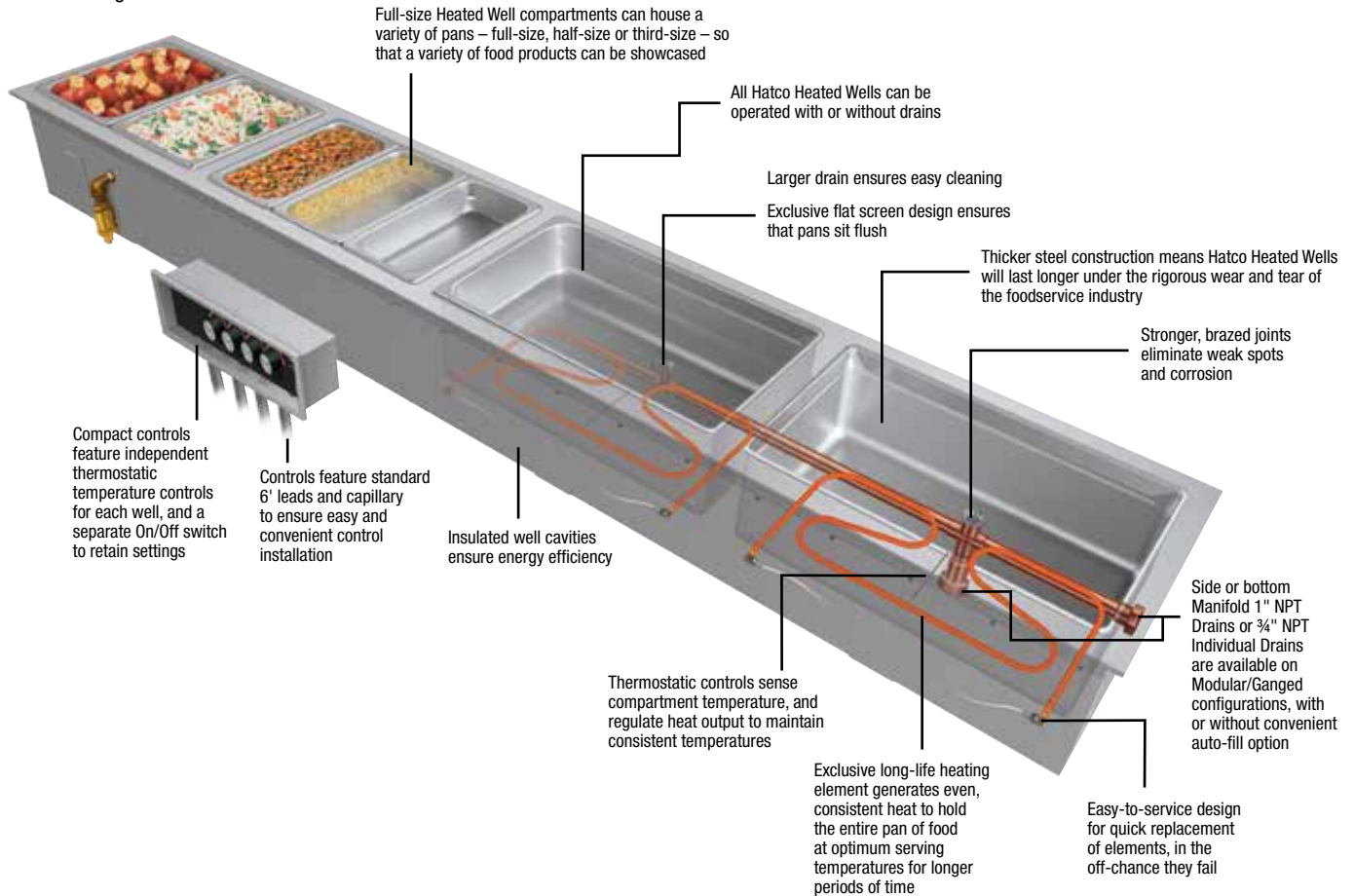

Please specify the following with each order:

1. **Desired Voltage:** 208 or 240V
 - A. Single phase (standard)
 - B. Three phase (optional)
2. **Number of Modular/Ganged Slim Heated Wells Required:** 2-, 3-, 4-pan

NOTE: Modular/Ganged Slim units are only offered as rectangular, full-size (12" x 20") but placed lengthwise
3. **Drain** (with or without – choose drain below):
 - A. Standard Individual Well 3/4" NPT Drain
 - B. Manifold 1" NPT Drain with side drain, field selectable left or right side
 - C. Manifold 1" NPT Drain with bottom drain, field selectable left or right well
4. **Auto-fill** (with or without)
5. **Bezel** allows a 19" D for modular units to match Hatco Refrigerated Slim Drop-In models in a countertop display
6. **Agency:**
 - A. UL
 - B. UL-EPH (sanitary listing)
7. **Control:**
 - A. Single Control Box (standard on all units)
 - B. Split Control Boxes (optional on 4-pan units, not available in Canada)

Accessories for Modular/Ganged Slim Heated Wells

1. **Pan Support Bars:** 12" or 20"
2. **Adapters** to convert Modular/Ganged Slim units to hold 4- or 7-quart round pans
3. **Stainless Steel Pans:**
 - A. Third-size at 2 1/2" deep (12 3/4"W x 6 7/8"D x 2 1/2"H)
 - B. Half-size at 2 1/2" deep (12 3/4"W x 10 3/8"D x 2 1/2"H)
 - C. Full-size at 2 1/2" deep (12 3/4"W x 20 3/4"D x 2 1/2"H)
 - D. Full-size at 4" deep (12 3/4"W x 20 3/4"D x 4"H)
 - E. Full-size at 6" deep (12 3/4"W x 20 3/4"D x 6"H)
4. **Valves:**
 - A. 3/4" or 1" NPT Ball Valve
 - B. 3/4" or 1" NPT Gate Valve
5. **Heated Well Covers** to convert Slim Modular/Ganged units to heated shelves:
 - A. 1-Pan Heated Well Cover

DROP-IN MODULAR/GANGED SLIM HEATED WELLS COUNTERTOP CUT-OUTS

Model	Minimum Width	Maximum Width	Minimum Depth	Maximum Depth
HWBI-S2 Series	44 1/8"	44 3/8"	14 1/4"	14 1/2"
HWBI-S3 Series	66 1/8"	66 3/8"	14 1/4"	14 1/2"
HWBI-S4 Series	88 1/8"	88 3/8"	14 1/4"	14 1/2"

ACCESSORIES – PAGES 40, 51-52

Modular/Ganged Slim Heated Wells

Hatco Modular/Ganged Slim Heated Wells are full-sized units that are grouped together in a modular fashion but placed lengthwise. This provides customers with a complete steam table within easy reach, regardless of the sneeze guards. Select the configuration that's right for your foodservice operation.

- Full-size, insulated wells available in 2- to 4-modular/ganged units
- Individual thermostatic controls for each well provide the ultimate in temperature regulation
- 6" conduit is standard for convenient placement of controls

- Wells empty quickly and easily with a manifold drain option
- Auto-fill option to automatically fill and replenish water without user maintenance and intervention
- Separate well assemblies with independent access to each one for easy service



HWBI-S4MA with accessory food pans and optional split control boxes

DROP-IN MODULAR/GANGED SLIM RECTANGULAR WELLS – INSULATED – TOP MOUNT

Model	Dimensions W x D x H	Watts	Ship Weight	List Price
HWBI-S2	45½" x 15⅝" x 9⅞"	2415	83 lbs.	\$3194
HWBI-S2D	45½" x 15⅝" x 9⅞"	2415	81 lbs.	3338
HWBI-S2DA*	45½" x 15⅝" x 9⅞"	2415	84 lbs.	3943
HWBI-S2M	45½" x 15⅝" x 9⅞"	2415	86 lbs.	3458
HWBI-S2MA	45½" x 15⅝" x 9⅞"	2415	90 lbs.	4261
HWBI-S3	67½" x 15⅝" x 9⅞"	3615	118 lbs.	4031
HWBI-S3D	67½" x 15⅝" x 9⅞"	3615	115 lbs.	4324
HWBI-S3DA*	67½" x 15⅝" x 9⅞"	3615	125 lbs.	4914
HWBI-S3M	67½" x 15⅝" x 9⅞"	3615	115 lbs.	4597
HWBI-S3MA	67½" x 15⅝" x 9⅞"	3615	125 lbs.	5402
HWBI-S4	89½" x 15⅝" x 9⅞"	4815	154 lbs.	5339
HWBI-S4D	89½" x 15⅝" x 9⅞"	4815	155 lbs.	5788
HWBI-S4DA*	89½" x 15⅝" x 9⅞"	4815	160 lbs.	6377
HWBI-S4M	89½" x 15⅝" x 9⅞"	4815	154 lbs.	6226
HWBI-S4MA	89½" x 15⅝" x 9⅞"	4815	153 lbs.	7007

* Auto-fill located on left control only and fills left-hand well. To fill all wells, drains must be connected with external manifold by installer.

All Drop-In Modular Slim Rectangular Heated Well Models Feature:
Voltage: HWBI-S2, -S3, -S4 Series: 208 or 240V, single phase or optional three phase.
Models Shipped with: EZ locking hardware for installation and remote thermostats with lighted power switches.

Modular/Ganged Slim Heated Wells Controls*

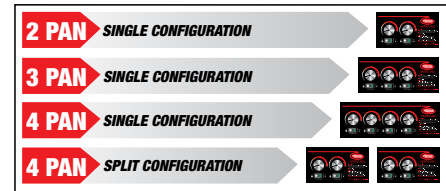

* 4-pan units: Single control box is standard. If optional split control boxes are desired, it must be specified at order (for Canada, split control boxes not available).

OPTIONS (available at time of purchase only)

HWBI-3PH	Three-Phase Wiring (field convertible)	No Charge
HWBI-SIDE	Copper Manifold Drain with side exit	No Charge
HWBI-BOTTOM	Copper Manifold Drain with bottom exit	No Charge
HWBI-CORD-S2	Cord for HWBI-S2 (single phase)	\$103
HWBI-CORD-S3, -S4	Cord for HWBI-S3, -S4 (single phase/single Control Box only)	103
OS-BEZEL19	19" D Bezel for Modular unit to match Hatco CWB Slim models in a countertop display	No Charge

COUNTERTOP CUT-OUT DIMENSIONS – PAGE 38 ACCESSORIES – PAGES 40, 51-52

DROP-IN SLIM MODULAR/GANGED 3 Ø AMP RATINGS

Model	208V/3 Ø Amps	240V/3 Ø Amps
HWBI-S2	10.1	8.7
HWBI-S3	10.1	8.8
HWBI-S4	15.8	13.7

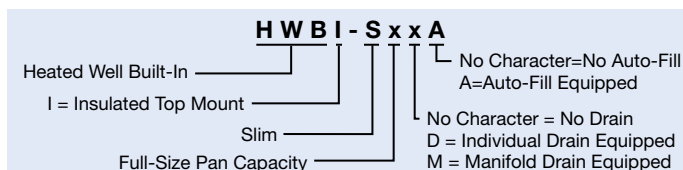

Modular/Ganged Heated Wells Accessories

(available for purchase at any time)

HEATED WELL COVERS (available for purchase at any time)

For Modular/Ganged Heated Wells and Modular/Ganged Slim Heated Wells. (Choose the number of heated well covers for your appropriate pan size in either 1 or 2-Pan sizes, not available for HWBI43 series) –

1-Pan Heated Well Cover (Overall: 14" W x 22" D x 2" H) –

1COVFUL-GGRAN	1 Heated Well Cover in Gray Granite	\$600
1COVFUL-BSAND	1 Heated Well Cover in Bermuda Sand	600
1COVFUL-NSKY	1 Heated Well Cover in Night Sky	600

2-Pan Heated Well Cover (Overall: 28" W x 22" D x 2" H) –

2COVFUL-GGRAN	2 Heated Well Cover in Gray Granite	\$1012
2COVFUL-BSAND	2 Heated Well Cover in Bermuda Sand	1012
2COVFUL-NSKY	2 Heated Well Cover in Night Sky	1012

ADDITIONAL ACCESSORIES – PAGES 51-52
COLORS AND FINISHES – INSIDE BACK COVER

HWBI-3
 (3-pan size) with accessory heated well covers (one 1-pan heated well cover and one 2-pan heated well cover)



1COVFUL-GGRAN
 accessory

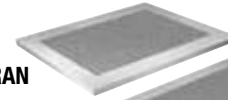

2COVFUL-GGRAN
 accessory

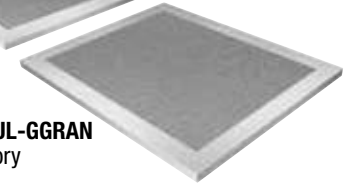

HEATED WELL COVER COMBINATIONS PER HWBI SERIES

Model Series	Using only: 1COVFUL	Model Series	Using both:	
			1COVFUL	2COVFUL
HWBI-1	1	HWBI-1	1	–
HWBI-2, -S2	2	HWBI-2	–	1
HWBI-3, -S3	3	HWBI-3	1	1
HWBI-4, -S4	4	HWBI-4	–	2
HWBI-5	5	HWBI-5	1	2
HWBI-6	6	HWBI-6	–	3



HWB-2-11Q

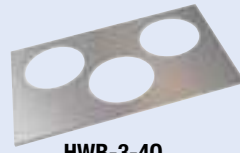

HWB-3-4Q

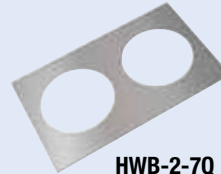

HWB-2-7Q

HWB-2-7Q
 shown with two 7QT-PAN and 7QT-LID-1



ADAPTERS – SUPPORT BARS

HWB-2-7Q	Adapter to convert warmer to hold two 7-Quart Inserts (HWBI and HWBI-S Modular Heated Wells only)	\$ 98
HWB-3-4Q	Adapter to convert warmer to hold three 4-Quart Inserts (HWBI and HWBI-S Modular Heated Wells only)	98
HWB-2-11Q	Adapter to convert warmer to hold two 11-Quart Inserts (HWBI43 Modular Heated Wells only)	123
HWBGM12BAR	12" Pan Support Bar for Drop-In Modular/Ganged Models	21
HWBGM20BAR	20" Pan Support Bar for Drop-In Modular/Ganged Models (not available for HWBI43 series)	25



Support Bars
 Choose the appropriate kit for HWBI or HWB series

MOUNTING KITS – VALVES

Necessary at your Well Installation –

HWB-MNT-REC	Kit allows mounting to thick, non-combustible countertops - 8 Brackets	\$90
--------------------	--	-------------

External Manifold includes Individual Ball Valve for each Well (HWBI only, not available for the Slim models) –

HWBI2MANIF	2-Pan Accessory	\$ 930
HWBI3MANIF	3-Pan Accessory	1320
HWBI4MANIF	4-Pan Accessory	1709
HWBI5MANIF	5-Pan Accessory	2099
HWBI6MANIF	6-Pan Accessory	2489

Necessary at your Well Installation –

BALLVALVE3/4	High Temperature 3/4" NPT Ball Valve for units with Individual Drain(s) and no Manifold	\$117
BALLVALVE1INCH	High Temperature 1" NPT Ball Valve for units with Manifold Drain	90
GATEVALVE3/4IN	High Temperature 3/4" NPT Gate Valve for units with Individual Drain(s) and no Manifold	135
GATEVALVE1INCH	High Temperature 1" NPT Gate Valve for units with Manifold Drain	200
HWB-RDHV	Heated Well Remote Handle for 3/4" Drains only and includes a Ball Valve	463



HWB-MNT-REC



HWBI2MANIF



BALLVALVE1INCH



GATEVALVE1INCH



HWB-RDHV
 Attaches to 3/4" Drain and includes a Ball Valve

Individual Built-In Heated Wells Ordering Instructions

Please specify the following with each order:

1. **Desired Voltage:** 120, 208 or 240V
2. **Base Size of Heated Well:**
 - A. Rectangular:
 - Full (12" x 20") or 4/3 (12" x 27")
 - B. Round:
 - 4-quart, 7-quart or 11-quart
3. **Drain** (with or without)
4. **Auto-fill** (with or without)
5. **Insulated or Uninsulated**



Insulated Well Construction
Full-size models are available with insulation for energy savings

6. **Mounting Style:**
 - A. Top Mounted
 - B. Bottom Mounted (rectangular full-size units only)
7. **Wattage:**
 - A. High watt
 - B. Standard watt
 - C. Low watt (120V only)

NOTE: Round Heated Wells are only available in standard and high watt configurations (4-quart available in standard watt only)
8. **Agency:**
 - A. UL and C-UL
 - B. UR (UL Recognized – Conduit and Control Enclosure not included [fabricators will need to obtain UL approvals])
 - C. C-UR (C-UL Recognized – Conduit and Control Enclosure not included [fabricators will need to obtain UL approvals])
 - D. UL-EPH (sanitary listing)



HWB-43D with accessory food pans (single unit holding 4 third-size pans – unit depth is 28 5/8")



Easy to access the heating elements, if it ever becomes necessary to change them

CONTROL BOXES, COUNTERTOP CUT-OUT DIMENSIONS – PAGE 42



Top Mounted Heated Well: Unit is mounted through the top surface of a sheet metal counter and secured with turn tabs (unit and food pan edge visible)



Bottom Mounted Heated Well: Full-size (only) unit is mounted to the bottom surface of a sheet metal counter and secured with customer provided turned bends and fasteners (only food pan edge visible)



H W B x x x - x D A

- Heated Well Built-In
- No Character = Standard Watt
- H = High Watt
- L = Low Wattage
- No Character = Uninsulated
- I = Insulated Top Mount
- IB=Insulated Bottom Mount
- RT = Thermostatic Control (UR Only)
- RN = Infinite Switch Control (UR Only)
- No Character = No Auto-Fill
- A = Auto-Fill Equipped
- No Character = No Drain
- D = Drain Equipped
- FUL = Full-Size Pan
- 43 = 4/3-Size Pan
- 4QT = Round 4-Liter Pan
- 7QT = Round 7-Liter Pan
- 11QT = Round 10-Liter Pan

Individual Built-In Heated Wells Ordering Instructions

Options for Individual Built-In Heated Wells

1. Control Box:

- A. Standard (compact) Thermostatic Control Box with Lighted On/Off Rocker Switch and Decorative Bezel. Can be front mounted or back mounted, and used with or without the Decorative Bezel (not available for auto-fill)
- B. Optional Larger (front mounted) Recessed Thermostatic Control Box with Lighted On/Off Rocker Switch and Angled Recessed Controls for easy readability (not available for auto-fill)
- C. Optional WM Control Assembly available that will replace most existing controls (not for auto-fill or Insulated Round Wells)
- D. Optional ITC Control (not available for auto-fill, 4-quart Round Wells, Insulated Round Wells or low watt configurations)
- E. Standard Control for auto-fill models only

2. Control Type:

- A. Thermostatic
- B. Infinite

NOTE: Infinite controls are only available on UR units (1 foot standard)

3. Leads – Extended high temp lead wire, per foot (1 foot standard)

4. Thermostat with 6' Capillary (3' standard)

5. Corners

- A. Standard (Rounded)
- B. Square Corners

Accessories for Individual Built-In Heated Wells

1. Mounting Kits for combustible countertops (individual drop-in top mount units only)

2. Pan Support Bars: 12" or 20"

3. Adapters to convert rectangular full-size units to hold 4- or 7-quart round pans, or 4/3-size units to hold 11-quart round pans

4. Stainless Steel Pans:

- A. Third-size at 2½" deep (12¾"W x 6⅞"D x 2½"H)
- B. Half-size at 2½" deep (12¾"W x 10⅞"D x 2½"H)
- C. Full-size at 2½" deep (12¾"W x 20¾"D x 2½"H)
- D. Full-size at 4" deep (12¾"W x 20¾"D x 4"H)
- E. Full-size at 6" deep (12¾"W x 20¾"D x 6"H)

CONTROLS FOR UL and C-UL MODELS

STANDARD CONTROLS

Standard Thermostatic Control with bezel



STANDARD CONTROL AUTO-FILL

Standard Control (only for auto-fill)



FABRICATOR CONTROLS ONLY – UR and C-UR Components

"RT" added to model number indicates unit with thermostatic control, lit rocker switch and 36" capillary



"RN" added to model number indicates unit with infinite switch control, pilot light and 36" leads



OPTIONAL CONTROLS



WM Control Assembly (not for auto-fill or Insulated Round Wells)



ITC Control (Not available for 4-quart Round Wells, low watt configurations, auto-fill or Insulated Round Wells)



Larger Recessed Thermostatic Control

CONTROL CUTOUT DIMENSIONS

Control Box	Width	Height
Standard Thermostatic (with bezel)	3¼"	3¾"
Optional WM Control Assembly	4¾"	5"
Optional Larger Recessed		
Thermostatic	5⅞"	6⅜"
Optional ITC	5⅞"	6⅜"
Standard Control for Auto-fill	10⅞"	4¾"

CONTROL CUTOUT DIMENSIONS

Control	Width	Height
Thermostatic	2⅞"	3⅜"
Infinite	2⅞"	3⅜"

5. Valve

- A. ¾" NPT Ball Valve for unit with Drain
- B. ¾" NPT Gate Valve for unit with Drain

6. Remote Handle for ¾" Drains only and includes a Ball Valve

How to Order a Hatco Heated Well in Video
Hatco has given you a variety of simple and easy ways to order your well. You can read the Ordering Instructions here or watch a video "How to Order a Hatco Heated Well." Go to hatcocorp.com and click on the Video Library. While you are there, watch the "Hatco Refrigerated Wells" video as well.

ACCESSORIES – PAGES 51-52



COMBUSTIBLE COUNTERTOP CUTOUTS – BUILT-IN AND DROP-IN HEATED WELLS

Model	Minimum Width	Maximum Width	Minimum Depth	Maximum Depth
HWB-FUL, -FULD, FULDA	14"	14¼"	22"	22¼"
HWBI-FUL, -FULD, FULDA	14"	14¼"	22"	22¼"
HWB-, HWBI-43	14"	14¼"	29"	29¼"
HWB-, HWBI-4QT	9"	9¼"	9"	9¼"
HWB-, HWBI-7QT	11"	11¼"	11"	11¼"
HWB-, HWBI-11QT	13"	13¼"	13"	13¼"

NON-COMBUSTIBLE COUNTERTOP CUTOUTS – BUILT-IN AND DROP-IN HEATED WELLS

Model	Minimum Width	Maximum Width	Minimum Depth	Maximum Depth
HWB-FUL, -FULD	12⅝"	12⅝"	20⅞"	20⅝"
HWB-FULDA	12⅝"	12⅝"	20⅞"	20⅝"
HWBI-FUL, -FULD	12¾"	12⅝"	20¾"	20⅝"
HWBI-FULDA*	12¾"	12⅝"	20⅞"	20⅝"
HWBIB-FUL*, -FULDA*	12⅜"	12⅜"	20⅜"	20⅜"
HWB-, HWBI-43	12⅜"	12⅜"	27⅜"	28"
HWB-4QT,	7⅞" Dia.	7⅞" Dia.	—	—
HWB-7QT	9⅞" Dia.	9⅞" Dia.	—	—
HWB-11QT	11⅞" Dia.	11⅞" Dia.	—	—
HWBI-4QT,	7⅞" Dia.	7⅞" Dia.	—	—
HWBI-7QT	9⅞" Dia.	9⅞" Dia.	—	—
HWBI-11QT	11⅞" Dia.	11⅞" Dia.	—	—

*Must be flanged.

Built-In Full-Size Heated Wells - UL and C-UL Models

Hatco Built-In Heated Wells hold heated foods at safe-serving temperatures. Compared to other models, Hatco units offer a larger drain with a flat drain screen, more consistent holding temperatures, heavier stainless steel construction, easier-to-service design for quick change of components and a remote thermostat with separate power switch.

- Rectangular full-size only in top or bottom mount, insulated or uninsulated
- Low (120V only), standard and high watt
- Available with or without a drain (easy to clean with a larger drain and a flat screen)
- Easy access design allows for quick element or thermostat change
- Available with optional square corners in lieu of standard round corners
- Accessory mounting kits for combustible countertops available
- Accessory adapters to convert full-size wells to hold round pans

Control Options

- See page 42



HWB-FULD with accessory food pan



HWBI-FULD with accessory food pan

HWBIB-FULD with accessory food pan

Wells

BUILT-IN FULL-SIZE RECTANGULAR UL AND C-UL WELLS

Model	Description	Dimensions W x D x H	Voltage	Watts	Ship Weight	List Price
Low Watt						
HWBL-FUL	Uninsulated Top or Bottom Mount	13 ¹¹ / ₁₆ " x 21 ³ / ₄ " x 9 ⁹ / ₁₆ "	120	750	22 lbs.	\$ 867
HWBL-FULD	Uninsulated Top or Bottom Mount w/Drain	13 ¹¹ / ₁₆ " x 21 ³ / ₄ " x 9 ⁹ / ₁₆ "	120	750	22 lbs.	916
HWBL-FULDA	Uninsulated Top or Bottom Mount w/Drain, Auto-fill	13 ¹¹ / ₁₆ " x 21 ³ / ₄ " x 9 ⁹ / ₁₆ "	120	765	21 lbs.†	1664
HWBLI-FUL	Insulated Top or Bottom Mount	13 ¹¹ / ₁₆ " x 21 ³ / ₄ " x 10 ⁹ / ₁₆ "	120	750	30 lbs.	986
HWBLI-FULD	Insulated Top or Bottom Mount w/Drain	13 ¹¹ / ₁₆ " x 21 ³ / ₄ " x 10 ⁹ / ₁₆ "	120	750	26 lbs.	1035
HWBLI-FULDA	Insulated Top Mount Only w/Drain, Auto-fill	13 ¹¹ / ₁₆ " x 21 ³ / ₄ " x 10 ⁹ / ₁₆ "	120	765	30 lbs.	1783
HWBLIB-FUL	Insulated Bottom Mount Only	13 ⁷ / ₈ " x 22 ¹ / ₈ " x 10 ⁹ / ₁₆ "	120	750	30 lbs.	986
HWBLIB-FULD	Insulated Bottom Mount Only w/Drain	13 ⁷ / ₈ " x 22 ¹ / ₈ " x 10 ⁹ / ₁₆ "	120	750	29 lbs.	1035
HWBLIB-FULDA	Insulated Bottom Mount Only w/Drain, Auto-fill	13 ⁷ / ₈ " x 22 ¹ / ₈ " x 10 ⁹ / ₁₆ "	120	765	35 lbs.	1783
Standard Watt						
HWB-FUL	Uninsulated Top or Bottom Mount	13 ¹¹ / ₁₆ " x 21 ³ / ₄ " x 9 ⁹ / ₁₆ "	120, 208 or 240	1200	22 lbs.	\$ 867
HWB-FULD	Uninsulated Top or Bottom Mount w/Drain	13 ¹¹ / ₁₆ " x 21 ³ / ₄ " x 9 ⁹ / ₁₆ "	120, 208 or 240	1200	22 lbs.	916
HWB-FULDA	Uninsulated Top or Bottom Mount w/Drain, Auto-fill	13 ¹¹ / ₁₆ " x 21 ³ / ₄ " x 9 ⁹ / ₁₆ "	120, 208 or 240	1215	31 lbs.†	1664
HWBI-FUL	Insulated Top or Bottom Mount	13 ¹¹ / ₁₆ " x 21 ³ / ₄ " x 10 ⁹ / ₁₆ "	120, 208 or 240	1200	26 lbs.	986
HWBI-FULD	Insulated Top or Bottom Mount w/Drain	13 ¹¹ / ₁₆ " x 21 ³ / ₄ " x 10 ⁹ / ₁₆ "	120, 208 or 240	1200	25 lbs.	1035
HWBI-FULDA	Insulated Top Mount Only w/Drain, Auto-fill	13 ¹¹ / ₁₆ " x 21 ³ / ₄ " x 10 ⁹ / ₁₆ "	120, 208 or 240	1215	30 lbs.	1783
HWBIB-FUL	Insulated Bottom Mount Only	13 ⁷ / ₈ " x 22 ¹ / ₈ " x 10 ⁹ / ₁₆ "	120, 208 or 240	1200	28 lbs.	986
HWBIB-FULD	Insulated Bottom Mount Only w/Drain	13 ⁷ / ₈ " x 22 ¹ / ₈ " x 10 ⁹ / ₁₆ "	120, 208 or 240	1200	28 lbs.	1035
HWBIB-FULDA	Insulated Bottom Mount Only w/Drain, Auto-fill	13 ⁷ / ₈ " x 22 ¹ / ₈ " x 10 ⁹ / ₁₆ "	120, 208 or 240	1215	35 lbs.	1783
High Watt						
HWBH-FUL	Uninsulated Top or Bottom Mount	13 ¹¹ / ₁₆ " x 21 ³ / ₄ " x 9 ⁹ / ₁₆ "	120, 208 or 240	1650	22 lbs.	\$ 867
HWBH-FULD	Uninsulated Top or Bottom Mount w/Drain	13 ¹¹ / ₁₆ " x 21 ³ / ₄ " x 9 ⁹ / ₁₆ "	120, 208 or 240	1650	22 lbs.	916
HWBH-FULDA	Uninsulated Top or Bottom Mount w/Drain, Auto-fill	13 ¹¹ / ₁₆ " x 21 ³ / ₄ " x 9 ⁹ / ₁₆ "	120, 208 or 240	1665	26 lbs.†	1664
HWBHI-FUL	Insulated Top or Bottom Mount	13 ¹¹ / ₁₆ " x 21 ³ / ₄ " x 10 ⁹ / ₁₆ "	120, 208 or 240	1650	26 lbs.	986
HWBHI-FULD	Insulated Top or Bottom Mount w/Drain	13 ¹¹ / ₁₆ " x 21 ³ / ₄ " x 10 ⁹ / ₁₆ "	120, 208 or 240	1650	31 lbs.	1035
HWBHI-FULDA	Insulated Top Mount Only w/Drain, Auto-fill	13 ¹¹ / ₁₆ " x 21 ³ / ₄ " x 10 ⁹ / ₁₆ "	120, 208 or 240	1665	30 lbs.	1783
HWBHIB-FUL	Insulated Bottom Mount Only	13 ⁷ / ₈ " x 22 ¹ / ₈ " x 10 ⁹ / ₁₆ "	120, 208 or 240	1650	30 lbs.	986
HWBHIB-FULD	Insulated Bottom Mount Only w/Drain	13 ⁷ / ₈ " x 22 ¹ / ₈ " x 10 ⁹ / ₁₆ "	120, 208 or 240	1650	30 lbs.	1035
HWBHIB-FULDA	Insulated Bottom Mount Only w/Drain, Auto-fill	13 ⁷ / ₈ " x 22 ¹ / ₈ " x 10 ⁹ / ₁₆ "	120, 208 or 240	1665	35 lbs.	1783

† Shipping weights are approximate.

All Built-In Full-Size Rectangular Heated Well Models Feature:

Voltage: Single phase.

Models Shipped with: EZ locking hardware for installation (top mounted only), 3' conduits between the control and well (except auto-fill unit) and a remote thermostat with lighted power switch.

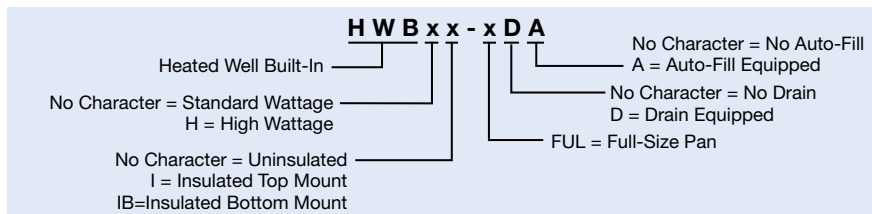

COUNTERTOP CUT-OUT DIMENSIONS - PAGE 42
OPTIONS - PAGE 44
ACCESSORIES - PAGES 51-52



HWBL-43D and HWBLI-FULD with accessory food pans (shown with **GR2AHL** with standard *Designer* non-adjustable stands and optional *Designer* Black and sneeze guards)



Standard Thermostatic Control with control box bezel in optional *Designer* Warm Red



HWB-ITC – Optional control (not available for auto-fill, units without a drain, or low watt configurations) shown in optional control box bezel in *Designer* White Granite

OPTIONS (available at time of purchase only)

Designer Colors for Flush Mount Control Box Bezel, not available for HWB-FUL w/cord – Non-standard colors are non-returnable – Stainless Steel is standard –

RED	Warm Red	\$46
BLACK	Black	46
GRAY	Gray Granite	46
WHITE	White Granite	46
NAVY	Navy Blue	46
GREEN	Hunter Green	46
COPPER	Antique Copper	46
HWB-LEAD	Power Supply Lead Wire (Lead Wire only – Conduit not included)	per foot \$13
HWB-CORD	HWB-FUL with Cord Standard (Shown below) (Not available for auto-fill models, low watt models available in 120V only)	add 39
HWBI-CORD	HWBI-FUL with Cord Standard (Shown below) All models except Insulated Top Mount with auto-fill, low watt models are available in 120V only)	add 39
HWBIB-BRKT	Mounting Bracket for Insulated Bottom Mount (HWBIB series)	add 26
HWB-SQUARE	Square Pan Corners (In lieu of standard round pan corners)	add 97
Control Options –		
HWB-TSTAT	Thermostat with 6' Capillary, (in lieu of standard 3', not available for auto-fill)	\$88
HWB-RTC	Larger Recessed Thermostatic Control Box (not available for auto-fill)	No Charge
HWB-ITC	ITC Control with Large Control Box (not available for auto-fill, units without a drain or low watt configurations)	\$294
WM Assembly	Control Assembly Replacement (not available for auto-fill models)	No Charge

HWB-FUL with optional HWB-CORD



HWBIB-FULD with optional HWBI-CORD and accessory food pan



ACCESSORIES – PAGE 51-52
COLORS AND FINISHES – INSIDE BACK COVER

Square Corner



Standard Corner



HWB-FUL with optional HWB-TSTAT Thermostat with 6' capillary (Not available for auto-fill)

Drop-In 4/3-Size Heated Wells - UL and C-UL Models

Convenient 4/3-Size Wells hold heated foods at safe-serving temperatures. Like the full-size models, Hatco units offer a larger drain with a flat drain screen, more consistent holding temperatures, heavier stainless steel construction, easier-to-service design for quick change of components and a remote thermostat with separate power switch.

- Rectangular 4/3-size wells
- Low (120V only), standard and high watt
- Available with or without a drain (easy to clean with larger drain and flat screen)
- Easy access design allows for quick element or thermostat change
- Accessory mounting kits for combustible countertops available
- Accessory adapters to convert 4/3-size wells to hold round pans available

Control Options

- See page 42

HWB-43D with accessory food pans (single unit holding 4 third-size pans)



HWBI-43D with accessory food pans (single unit holding 4 third-size pans)



DROP-IN 4/3-SIZE RECTANGULAR UL AND C-UL WELLS

Model	Description	Dimensions W x D x H	Voltage	Watts	Ship Weight	List Price
Low Watt						
HWBL-43	Uninsulated	13 ⁵ / ₈ " x 28 ⁵ / ₈ " x 9 ⁷ / ₁₆ "	120	750	35 lbs.	\$ 966
HWBL-43D	Uninsulated w/Drain	13 ⁵ / ₈ " x 28 ⁵ / ₈ " x 9 ⁷ / ₁₆ "	120	750	24 lbs.	1015
HWBL-43DA	Uninsulated w/Drain, Auto-fill	13 ⁵ / ₈ " x 28 ⁵ / ₈ " x 9 ⁷ / ₁₆ "	120	765	36 lbs.	1763
HWBLI-43	Insulated	13 ⁵ / ₈ " x 28 ⁵ / ₈ " x 10 ¹ / ₁₆ "	120	750	33 lbs.	1085
HWBLI-43D	Insulated w/Drain	13 ⁵ / ₈ " x 28 ⁵ / ₈ " x 10 ¹ / ₁₆ "	120	750	31 lbs.	1134
Standard Watt						
HWB-43	Uninsulated	13 ⁵ / ₈ " x 28 ⁵ / ₈ " x 9 ⁷ / ₁₆ "	120, 208 or 240	1200	24 lbs.	\$ 966
HWB-43D	Uninsulated w/Drain	13 ⁵ / ₈ " x 28 ⁵ / ₈ " x 9 ⁷ / ₁₆ "	120, 208 or 240	1200	24 lbs.	1015
HWB-43DA	Uninsulated w/Drain, Auto-fill	13 ⁵ / ₈ " x 28 ⁵ / ₈ " x 9 ⁷ / ₁₆ "	120, 208 or 240	1215	27 lbs.	1763
HWBI-43	Insulated	13 ⁵ / ₈ " x 28 ⁵ / ₈ " x 10 ¹ / ₁₆ "	120, 208 or 240	1200	30 lbs.	1085
HWBI-43D	Insulated w/Drain	13 ⁵ / ₈ " x 28 ⁵ / ₈ " x 10 ¹ / ₁₆ "	120, 208 or 240	1200	31 lbs.	1134
High Watt						
HWBH-43	Uninsulated	13 ⁵ / ₈ " x 28 ⁵ / ₈ " x 9 ⁷ / ₁₆ "	120, 208 or 240	1650	24 lbs.	\$ 966
HWBH-43D	Uninsulated w/Drain	13 ⁵ / ₈ " x 28 ⁵ / ₈ " x 9 ⁷ / ₁₆ "	120, 208 or 240	1650	24 lbs.	1015
HWBH-43DA	Uninsulated w/Drain, Auto-fill	13 ⁵ / ₈ " x 28 ⁵ / ₈ " x 9 ⁷ / ₁₆ "	120, 208 or 240	1665	30 lbs.	1763
HWBHI-43	Insulated	13 ⁵ / ₈ " x 28 ⁵ / ₈ " x 10 ¹ / ₁₆ "	120, 208 or 240	1650	30 lbs.	1085
HWBHI-43D	Insulated w/Drain	13 ⁵ / ₈ " x 28 ⁵ / ₈ " x 10 ¹ / ₁₆ "	120, 208 or 240	1650	30 lbs.	1134

All Drop-In 4/3-Size Rectangular Heated Well Models Feature:

Voltage: Single phase.

Models Shipped with: EZ locking hardware for installation, 3' conduits between the control and well (except auto-fill unit) and a remote thermostat with lighted power switch.

OPTIONS (available at time of purchase only)

HWB-LEAD	Power Supply Lead Wire (Lead Wire only - Conduit not included)	per foot \$13
HWB-AFL	Models HWB, HWBH, HWBL-43DA only - Left water fill hole (front is standard)	No Charge
HWB-AFR	Models HWB, HWBH, HWBL-43DA only - Right water fill hole (front is standard)	No Charge
Control Options -		
HWB-TSTAT	Thermostat with 6' Capillary (in lieu of standard 3', not available for auto-fill)	\$88
HWB-RTC	Larger Recessed Thermostatic Control Box (not available for auto-fill)	No Charge
WM Assembly	Control Assembly Replacement (not available for auto-fill models)	No Charge
HWB-ITC	ITC Control with Large Control Box (not available for auto-fill, units without a drain or low watt configurations)	\$294

Designer Colors (Control Box Bezel) -

Non-standard colors are non-returnable - Stainless Steel is standard -

RED	Warm Red	\$46
BLACK	Black	46
GRAY	Gray Granite	46
WHITE	White Granite	46
NAVY	Navy Blue	46
GREEN	Hunter Green	46
COPPER	Antique Copper	46

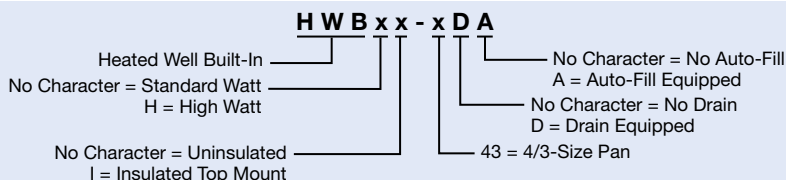

COUNTERTOP CUT-OUT DIMENSIONS - PAGE 42
ACCESSORIES - PAGES 51-52
COLORS AND FINISHES - INSIDE BACK COVER

Drop-In Round Uninsulated Heated Wells – UL And C-UL Models

Keeping hot food at safe-serving temperatures is critical to any foodservice operation – and Hatco has the Heated Wells to meet the demands of any serving application. Thermostatic controls monitor and regulate the temperature of the well for more accurate heat and energy savings. Hatco controls feature a separate On/Off switch, which allows a previously determined setting to be maintained.

- 4-, 7- and 11-quart Round Wells
- Standard or high watt (4-quart standard watt only)
- With or without drain
- EZ locking hardware for easy top mount installation
- Accessory mounting kits for combustible countertops available



Control Options

- Standard (compact) thermostatic control box with lighted On/Off rocker switch and decorative bezel. Can be front mounted or back mounted, and used with or without the decorative bezel
- Optional larger (front mounted) recessed thermostatic control box with lighted On/Off rocker switch and angled recessed controls for easy readability
- Optional WM control assembly available to replace most existing controls on a customer's Drop-In Heated Well unit for easier reading
- Optional ITC control with large control box available for easier reading on 7- or 11-quart standard or high watt configurations

DROP-IN ROUND UL AND C-UL WELLS – UNINSULATED

Model	Description	Dimensions Dia. x H	Watts			Ship Weight	List Price
			120V	208V	240V		
4-Quart – Standard Watt							
HWB-4QT	Top Mount	8 ³ / ₈ " x 10 ⁵ / ₈ "	500	536	600	11 lbs.	\$825
HWB-4QTD	Top Mount w/Drain	8 ³ / ₈ " x 10 ⁵ / ₈ "	500	536	600	10 lbs.	874
7-Quart – Standard Watt							
HWB-7QT	Top Mount	10 ¹ / ₁₆ " x 9 ⁹ / ₈ "	500	536	600	12 lbs.	\$825
HWB-7QTD	Top Mount w/Drain	10 ¹ / ₁₆ " x 9 ⁹ / ₈ "	500	536	600	12 lbs.	874
7-Quart – High Watt							
HWBH-7QT	Top Mount	10 ¹ / ₁₆ " x 9 ⁹ / ₈ "	800	715	800	12 lbs.	\$825
HWBH-7QTD	Top Mount w/Drain	10 ¹ / ₁₆ " x 9 ⁹ / ₈ "	800	715	800	12 lbs.	874
11-Quart – Standard Watt							
HWB-11QT	Top Mount	12 ⁵ / ₁₆ " x 9 ⁵ / ₈ "	500	536	600	13 lbs.	\$825
HWB-11QTD	Top Mount w/Drain	12 ⁵ / ₁₆ " x 9 ⁵ / ₈ "	500	536	600	14 lbs.	874
11-Quart – High Watt							
HWBH-11QT	Top Mount	12 ⁵ / ₁₆ " x 9 ⁵ / ₈ "	800	715	800	13 lbs.	\$825
HWBH-11QTD	Top Mount w/Drain	12 ⁵ / ₁₆ " x 9 ⁵ / ₈ "	800	715	800	13 lbs.	874



Optional larger recessed thermostatic control



Standard thermostatic control with bezel



WM control assembly



Optional ITC control – (not for 4-quart Round Wells or units without drains) shown in optional control box bezel in Designer White Granite

All Drop-In Round Heated Well Models Feature:

Voltage: Single phase.

Models Shipped with: EZ locking hardware for installation, 3' conduits between the control and well and a remote thermostat with lighted power switch.

OPTIONS (available at time of purchase only)

HWB-LEAD	Power Supply Lead Wire (Lead Wire only – Conduit not included)	per foot \$13
HWB-CORD	Optional cord available on models attached to control box in lieu of conduit and lead wire (120V only)	add 39
Control Options –		
HWB-TSTAT	Thermostat with 6' Capillary (in lieu of standard 3', not available for auto-fill)	\$88
HWB-RTC	Larger Recessed Thermostatic Control Box (not available for auto-fill)	No Charge
WM Assembly	Control Assembly Replacement	No Charge
HWB-ITC	ITC Control with large Control Box for 7- and 11-Quart Drop-In Round Wells only	\$294

Designer Colors (Control Box Bezel) –

Non-standard colors are non-returnable –

Stainless Steel is standard –

RED	Warm Red	\$46
BLACK	Black	46
GRAY	Gray Granite	46
WHITE	White Granite	46
NAVY	Navy Blue	46
GREEN	Hunter Green	46
COPPER	Antique Copper	46

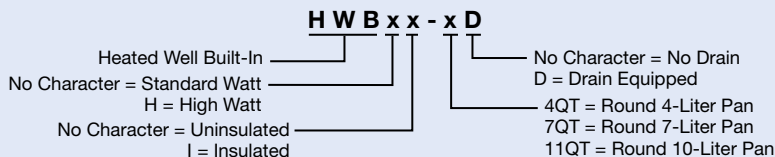

COUNTERTOP CUT-OUT DIMENSIONS – PAGE 42
ACCESSORIES – PAGES 51-52
COLORS AND FINISHES – INSIDE BACK COVER

Drop-In Round Insulated Heated Wells - UL And C-UL Models

Hatco Drop-In Round Insulated Heated Wells provide flexibility and quality, with many options to choose from. These units hold steam table food hot and fresh with self-adjusting thermostats that monitor the actual temperatures and control the heat only when needed.

- Available in insulated 4-, 7- and 10-liter Round Wells
- Standard or high watt (4-liter standard watt only)
- Controls feature a separate lighted ON/OFF rocker switch and temperature dial, allowing preset temperatures to be maintained
- Easy service access to heating elements and thermostats
- Mounting kits for combustible countertops available
- Auto-Fill models available in 7 and 10 liter round wells

Control Options

- Larger front-mounted recessed thermostatic control box with lighted On/Off rocker switch and angled recessed controls for easy readability



Larger recessed thermostatic control at no charge



HWBI-7QTD
with accessory
food pan

HWBI-11QTD with
accessory food pan

DROP-IN ROUND UL AND C-UL WELLS – INSULATED

Model	Description	Dimensions Dia. x H	Watts			Ship Weight	List Price
			120V	208V	240V		
4-Liter (4-Quart) – Standard Watt							
HWBI-4QT	Top Mount	8 ⁵ / ₁₆ " x 10 ¹ / ₁₆ "	500	536	600	12 lbs.	\$944
HWBI-4QTD	Top Mount w/Drain	8 ⁵ / ₁₆ " x 10 ¹ / ₁₆ "	500	536	600	13 lbs.	993
7-Liter (7-Quart) – Standard Watt							
HWBI-7QT	Top Mount	10 ⁵ / ₁₆ " x 9 ³ / ₄ "	500	536	600	12 lbs.	\$ 944
HWBI-7QTD	Top Mount w/Drain	10 ⁵ / ₁₆ " x 9 ³ / ₄ "	500	536	600	15 lbs.	993
HWBI-7QTD A	Top Mount w/Drain, Auto-fill	10 ⁵ / ₁₆ " x 9 ³ / ₄ "	515	551	615	15 lbs.	1741
7-Liter (7-Quart) – High Watt							
HWBHI-7QT	Top Mount	10 ⁵ / ₁₆ " x 9 ³ / ₄ "	800	715	800	13 lbs.	\$ 944
HWBHI-7QTD	Top Mount w/Drain	10 ⁵ / ₁₆ " x 9 ³ / ₄ "	800	715	800	15 lbs.	993
HWBHI-7QTD A	Top Mount w/Drain, Auto-fill	10 ⁵ / ₁₆ " x 9 ³ / ₄ "	815	730	815	19 lbs.	1741
10-Liter (11-Quart) – Standard Watt							
HWBI-11QT	Top Mount	12 ⁵ / ₁₆ " x 9 ³ / ₄ "	500	536	600	16 lbs.	\$ 944
HWBI-11QTD	Top Mount w/Drain	12 ⁵ / ₁₆ " x 9 ³ / ₄ "	500	536	600	21 lbs.	993
HWBI-11QTD A	Top Mount w/Drain, Auto-fill	12 ⁵ / ₁₆ " x 9 ³ / ₄ "	515	551	615	23 lbs.	1741
10-Liter (11-Quart) – High Watt							
HWBHI-11QT	Top Mount	12 ⁵ / ₁₆ " x 9 ³ / ₄ "	800	715	800	16 lbs.	\$ 944
HWBHI-11QTD	Top Mount w/Drain	12 ⁵ / ₁₆ " x 9 ³ / ₄ "	800	715	800	16 lbs.	993
HWBHI-11QTD A	Top Mount w/Drain, Auto-fill	12 ⁵ / ₁₆ " x 9 ³ / ₄ "	815	730	815	27 lbs.	1741

All Drop-In Round Insulated Heated Well Models Feature:

Voltage: Single phase.

Models Shipped with: EZ locking hardware for installation, 3' conduit and a remote thermostat with lighted power switch.

OPTIONS (available at time of purchase only)

HWB-LEAD	Power Supply Lead Wire (Lead Wire only – Conduit not included)	per foot \$13
HWBI-CORD	Optional cord available on models attached to control box in lieu of conduit and lead wire (120V only)	add 39
Control Options –		
HWB-TSTAT	Thermostat with 6' Capillary (in lieu of standard 3', not available for auto-fill)	\$88
HWB-RTC	Larger Recessed Thermostatic Control (not available for auto-fill)	No Charge

HWB x x - x D A

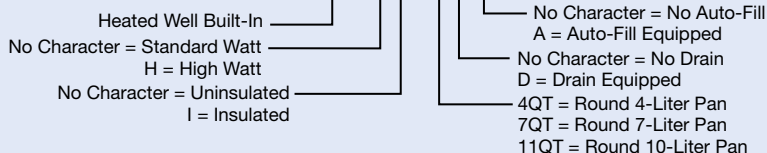

COUNTERTOP CUT-OUT DIMENSIONS – PAGE 42
ACCESSORIES – PAGES 51-52



Built-In Full-Size Heated Wells - UR and C-UR Components

Having the same great features as all of the Hatco Heated Wells, plus the added benefit of allowing fabricators the freedom to design their own steam tables, these units hold hot food products at safe-serving temperatures.

- Without conduit and control box enclosure
- Thermostatic or infinite controls available (infinite switch option not available on 120V high watt)
- With or without drains
- Low, standard and high watt models
- Available with optional square corners in lieu of standard round corners



HWBRT-FULD with accessory food pan

Control Options

- See page 42

HWBIBRT-FULD with accessory food pan



HWBIBRT-FULD with accessory food pan

NOTE: Fabricators will need to obtain UL approvals.

BUILT-IN FULL-SIZE RECTANGULAR WELLS UR AND C-UR COMPONENTS

Model #	Description	Dimensions (W x D x H)	Voltage	Watts	Ship Weight	List Price
Low Watt						
HWBLRT-FUL	Uninsulated Top or Bottom Mount	13 ¹¹ / ₁₆ " x 21 ³ / ₄ " x 9 ³ / ₈ "	120	750	21 lbs.	\$772
HWBLRT-FULD	Uninsulated Top or Bottom Mount w/Drain	13 ¹¹ / ₁₆ " x 21 ³ / ₄ " x 9 ³ / ₈ "	120	750	20 lbs.	821
HWBLRN-FUL	Uninsulated Top or Bottom Mount	13 ¹¹ / ₁₆ " x 21 ³ / ₄ " x 9 ³ / ₈ "	120	750	19 lbs.	772
HWBLRN-FULD	Uninsulated Top or Bottom Mount w/Drain	13 ¹¹ / ₁₆ " x 21 ³ / ₄ " x 9 ³ / ₈ "	120	750	20 lbs.	821
HWBLIRT-FUL	Insulated Top or Bottom Mount	13 ¹¹ / ₁₆ " x 21 ³ / ₄ " x 10 ⁵ / ₁₆ "	120	750	27 lbs.	891
HWBLIRT-FULD	Insulated Top or Bottom Mount w/Drain	13 ¹¹ / ₁₆ " x 21 ³ / ₄ " x 10 ⁵ / ₁₆ "	120	750	19 lbs.	940
HWBLIBRT-FUL	Insulated Bottom Mount Only	13 ⁷ / ₈ " x 22 ¹ / ₈ " x 10 ⁵ / ₁₆ "	120	750	28 lbs.	891
HWBLIBRT-FULD	Insulated Bottom Mount Only w/Drain	13 ⁷ / ₈ " x 22 ¹ / ₈ " x 10 ⁵ / ₁₆ "	120	750	26 lbs.	940
Standard Watt						
HWBRT-FUL	Uninsulated Top or Bottom Mount	13 ¹¹ / ₁₆ " x 21 ³ / ₄ " x 9 ³ / ₈ "	120, 208 or 240	1200	19 lbs.	\$772
HWBRT-FULD	Uninsulated Top or Bottom Mount w/Drain	13 ¹¹ / ₁₆ " x 21 ³ / ₄ " x 9 ³ / ₈ "	120, 208 or 240	1200	20 lbs.	821
HWBRN-FUL	Uninsulated Top or Bottom Mount	13 ¹¹ / ₁₆ " x 21 ³ / ₄ " x 9 ³ / ₈ "	120, 208 or 240	1200	19 lbs.	772
HWBRN-FULD	Uninsulated Top or Bottom Mount w/Drain	13 ¹¹ / ₁₆ " x 21 ³ / ₄ " x 9 ³ / ₈ "	120, 208 or 240	1200	20 lbs.	821
HWBIRT-FUL	Insulated Top or Bottom Mount	13 ¹¹ / ₁₆ " x 21 ³ / ₄ " x 10 ⁵ / ₁₆ "	120, 208 or 240	1200	24 lbs.	891
HWBIRT-FULD	Insulated Top or Bottom Mount w/Drain	13 ¹¹ / ₁₆ " x 21 ³ / ₄ " x 10 ⁵ / ₁₆ "	120, 208 or 240	1200	26 lbs.	940
HWBIBRT-FUL	Insulated Bottom Mount Only	13 ⁷ / ₈ " x 22 ¹ / ₈ " x 10 ⁵ / ₁₆ "	120, 208 or 240	1200	26 lbs.	891
HWBIBRT-FULD	Insulated Bottom Mount Only w/Drain	13 ⁷ / ₈ " x 22 ¹ / ₈ " x 10 ⁵ / ₁₆ "	120, 208 or 240	1200	26 lbs.	940
High Watt						
HWBHRT-FUL	Uninsulated Top or Bottom Mount	13 ¹¹ / ₁₆ " x 21 ³ / ₄ " x 9 ³ / ₈ "	120, 208 or 240	1650	21 lbs.	\$772
HWBHRT-FULD	Uninsulated Top or Bottom Mount w/Drain	13 ¹¹ / ₁₆ " x 21 ³ / ₄ " x 9 ³ / ₈ "	120, 208 or 240	1650	18 lbs.	821
HWBHRN-FUL	Uninsulated Top or Bottom Mount	13 ¹¹ / ₁₆ " x 21 ³ / ₄ " x 9 ³ / ₈ "	208 or 240	1650	21 lbs.	772
HWBHRN-FULD	Uninsulated Top or Bottom Mount w/Drain	13 ¹¹ / ₁₆ " x 21 ³ / ₄ " x 9 ³ / ₈ "	208 or 240	1650	20 lbs.	821
HWBHIRT-FUL	Insulated Top or Bottom Mount	13 ¹¹ / ₁₆ " x 21 ³ / ₄ " x 10 ⁵ / ₁₆ "	120, 208 or 240	1650	26 lbs.	891
HWBHIRT-FULD	Insulated Top or Bottom Mount w/Drain	13 ¹¹ / ₁₆ " x 21 ³ / ₄ " x 10 ⁵ / ₁₆ "	120, 208 or 240	1650	28 lbs.	940
HWBHBRT-FUL	Insulated Bottom Mount Only	13 ⁷ / ₈ " x 22 ¹ / ₈ " x 10 ⁵ / ₁₆ "	120, 208 or 240	1650	28 lbs.	891
HWBHBRT-FULD	Insulated Bottom Mount Only w/Drain	13 ⁷ / ₈ " x 22 ¹ / ₈ " x 10 ⁵ / ₁₆ "	120, 208 or 240	1650	28 lbs.	940

"RT" added to model name indicates unit with thermostat control, lit rocker switch and 36" capillary. "RN" added to model name indicates unit with infinite switch control, pilot light and 36" leads.

All Built-In Full-Size Rectangular UR and C-UR Heated Well Models Feature:

Voltage: Single phase.

Models Shipped with: EZ locking hardware for installation (top mounted only).

OPTIONS (available at time of purchase only), UR and C-UR COMPONENTS ONLY

HWB-LEAD-UR	Power Supply Lead Wire for "RN" Components (Lead Wire only - Conduit not included)	per foot	\$13
HWB-SQUARE	Square Pan Corners (In lieu of standard round pan corners)	add	97
Control Options -			
HWB-TSTAT-UR	Thermostat with 6' Capillary for "RT" Components (in lieu of standard 3', Thermostat only - Conduit not included)		62

Standard Corner



Square Corner



HWB x x x - x D

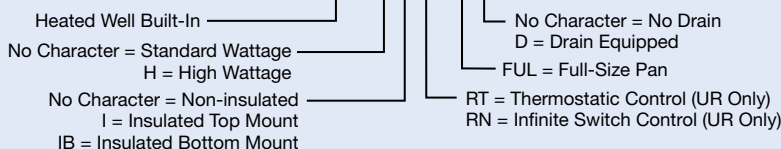

COUNTERTOP CUT-OUT DIMENSIONS - PAGE 42
ACCESSORIES - PAGES 51-52

Drop-In 4/3-Size Heated Wells – UR and C-UR Components

Having the same great features as all of the Hatco Heated Wells, plus the added benefit of allowing fabricators the freedom to design their own steam tables with UL recognized components, these units hold hot food products at safe-serving temperatures.

- Without conduit and control box enclosure
- Thermostatic or infinite controls available (infinite switch option not available on 120V high watt)
- With or without drains
- Low, standard and high watt models



HWBRT-43D with accessory food pans (single unit can hold 4 third-size pans)

NOTE: Fabricators will need to obtain UL approvals.

Control Options

The UR and C-UR models can have the following control choices:

- Thermostatic controls, which feature an On/Off switch with light
- Infinite controls – available with indicator light (infinite switch option not available on 120V high watt)



Thermostatic control



Infinite control

CONTROL CUTOUT DIMENSIONS

Control	Width	Height
Thermostatic	2 1/8"	3 3/8"
Infinite	2 1/8"	3 3/8"

DROP-IN 4/3-SIZE RECTANGULAR WELLS UR AND C-UR COMPONENTS

Model #	Description	Dimensions W x D x H	Voltage	Watts	Ship Weight	List Price
Low Watt						
HWBLRT-43	Uninsulated	13 5/8" x 28 5/8" x 9 3/8"	120	750	30 lbs.	\$871
HWBLRT-43D	Uninsulated w/Drain	13 5/8" x 28 5/8" x 9 3/8"	120	750	33 lbs.	920
HWBLRN-43	Uninsulated	13 5/8" x 28 5/8" x 9 3/8"	120	750	21 lbs.	871
HWBLRN-43D	Uninsulated w/Drain	13 5/8" x 28 5/8" x 9 3/8"	120	750	33 lbs.	920
Standard Watt						
HWBRT-43	Uninsulated	13 5/8" x 28 5/8" x 9 3/8"	120, 208 or 240	1200	23 lbs.	\$871
HWBRT-43D	Uninsulated w/Drain	13 5/8" x 28 5/8" x 9 3/8"	120, 208 or 240	1200	21 lbs.	920
HWBRN-43	Uninsulated	13 5/8" x 28 5/8" x 9 3/8"	120, 208 or 240	1200	21 lbs.	871
HWBRN-43D	Uninsulated w/Drain	13 5/8" x 28 5/8" x 9 3/8"	120, 208 or 240	1200	21 lbs.	920
High Watt						
HWBHRT-43	Uninsulated	13 5/8" x 28 5/8" x 9 3/8"	120, 208 or 240	1650	30 lbs.	\$871
HWBHRT-43D	Uninsulated w/Drain	13 5/8" x 28 5/8" x 9 3/8"	120, 208 or 240	1650	21 lbs.	920
HWBHRRN-43	Uninsulated	13 5/8" x 28 5/8" x 9 3/8"	208 or 240	1650	30 lbs.	871
HWBHRRN-43D	Uninsulated w/Drain	13 5/8" x 28 5/8" x 9 3/8"	208 or 240	1650	33 lbs.	920

"RT" added to model name indicates unit with thermostat control, lit rocker switch and 36" capillary.
 # "RN" added to model name indicates unit with infinite switch control, pilot light and 36" leads.

All Drop-In 4/3-Size Rectangular UR and C-UR Heated Well Models Feature:

Voltage: Single phase.

Models Shipped with: EZ locking hardware for installation.

OPTIONS (available at time of purchase only), UR and C-UR COMPONENTS ONLY

HWB-LEAD-UR	Power Supply Lead Wire for "RN" Components (Lead Wire only – Conduit not included)	per foot \$13
Control Options –		
HWB-TSTAT-UR	Thermostat with 6' Capillary for "RT" Components (in lieu of standard 3', Thermostat only – Conduit not included)	62

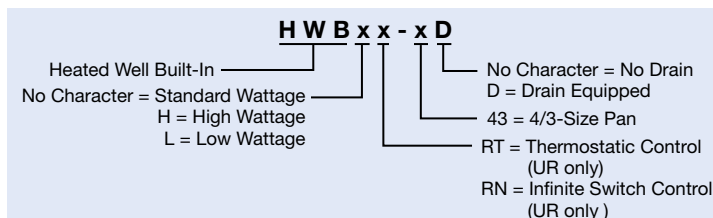

COUNTERTOP CUT-OUT DIMENSIONS – PAGE 42
ACCESSORIES – PAGES 51-52

Drop-In Round Heated Wells - UR and C-UR Components

Ideal for the fabricator who wants to design a specific steam table layout. Easy to install, and easy to service, the Round Heated Wells come with control, size, drain and wattage choices.

- 4-, 7- and 11-quart Round Heated Wells
- Standard or high watt (4-quart standard watt only)
- With or without drain
- Thermostatic or infinite controls available
- Without conduit and control box enclosure

HWBRT-7QT with accessory food pan (not included)



HWBRT-11QT with accessory food pan (not included)

HWBRT-4QT with accessory food pan (not included)

NOTE: Fabricators will need to obtain UL approvals.

DROP-IN ROUND WELLS UR AND C-UR COMPONENTS – UNINSULATED

Model #	Description	Dimensions Dia. x H	Watts			Ship Weight	List Price
			120V	208V	240V		
4-Quart – Standard Watt							
HWBRT-4QT	Top Mount	8 3/8" x 10 5/8"	500	536	600	9 lbs.	\$730
HWBRT-4QTD	Top Mount w/Drain	8 3/8" x 10 5/8"	500	536	600	9 lbs.	779
HWBRN-4QT	Top Mount	8 3/8" x 10 5/8"	500	536	600	6 lbs.	730
HWBRN-4QTD	Top Mount w/Drain	8 3/8" x 10 5/8"	500	536	600	10 lbs.	779
7-Quart – Standard Watt							
HWBRT-7QT	Top Mount	10 5/16" x 9 5/8"	500	536	600	11 lbs.	\$730
HWBRT-7QTD	Top Mount w/Drain	10 5/16" x 9 5/8"	500	536	600	11 lbs.	779
HWBRN-7QT	Top Mount	10 5/16" x 9 5/8"	500	536	600	7 lbs.	730
HWBRN-7QTD	Top Mount w/Drain	10 5/16" x 9 5/8"	500	536	600	10 lbs.	779
7-Quart – High Watt							
HWBHRT-7QT	Top Mount	10 5/16" x 9 5/8"	800	715	800	11 lbs.	\$730
HWBHRT-7QTD	Top Mount w/Drain	10 5/16" x 9 5/8"	800	715	800	9 lbs.	779
HWBHRTN-7QT	Top Mount	10 5/16" x 9 5/8"	800	715	800	7 lbs.	730
HWBHRTN-7QTD	Top Mount w/Drain	10 5/16" x 9 5/8"	800	715	800	13 lbs.	779
11-Quart – Standard Watt							
HWBRT-11QT	Top Mount	12 5/16" x 9 5/8"	500	536	600	10 lbs.	\$730
HWBRT-11QTD	Top Mount w/Drain	12 5/16" x 9 5/8"	500	536	600	11 lbs.	779
HWBRN-11QT	Top Mount	12 5/16" x 9 5/8"	500	536	600	10 lbs.	730
HWBRN-11QTD	Top Mount w/Drain	12 5/16" x 9 5/8"	500	536	600	11 lbs.	779
11-Quart – High Watt							
HWBHRT-11QT	Top Mount	12 5/16" x 9 5/8"	800	715	800	15 lbs.	\$730
HWBHRT-11QTD	Top Mount w/Drain	12 5/16" x 9 5/8"	800	715	800	11 lbs.	779
HWBHRTN-11QT	Top Mount	12 5/16" x 9 5/8"	800	715	800	10 lbs.	730
HWBHRTN-11QTD	Top Mount w/Drain	12 5/16" x 9 5/8"	800	715	800	13 lbs.	779

"RT" added to model name indicates unit with thermostatic control, lit rocker switch and 36" capillary.
 # "RN" added to model name indicates unit with infinite switch control, pilot light and 36" leads.

All Drop-In Round UR and C-UR Heated Well Models Feature:

Voltage: Single phase.

Models Shipped with: EZ locking hardware for installation.

Control Options

The UR and C-UR models can have the following control choices:

- Thermostatic controls, which feature an On/Off switch with light
- Infinite controls – available with indicator light



Thermostatic control



Infinite control

CONTROL CUTOUT DIMENSIONS

Control	Width	Height
Thermostatic	2 1/8"	3 3/8"
Infinite	2 1/8"	3 3/8"

OPTIONS (available at time of purchase only), UR and C-UR COMPONENTS ONLY

HWB-LEAD-UR	Power Supply Lead Wire for "RN" Components (Lead Wire only – Conduit not included)	per foot \$13
Control Options –		
HWB-TSTAT-UR	Thermostat with 6' Capillary for "RT" Components (in lieu of standard 3', Thermostat only – Conduit not included)	\$62

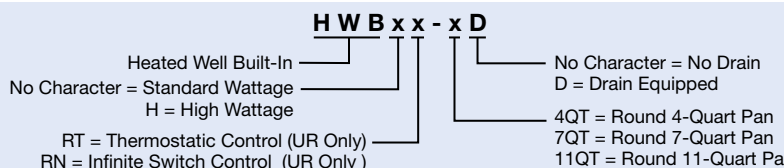

COUNTERTOP CUT-OUT DIMENSIONS – PAGE 42
ACCESSORIES – PAGES 51-52

Drop-In Hot/Cold Well and Heated Well Accessories

(available for purchase at any time)



FTB-2
with accessory
full-size
sheet pans

HWBI-2
with accessory
half and third-size
food pans

ST PAN 1/3
ST PAN 1/2
ST PAN 2
ST PAN 4

HDW 6" PAN

PANS – LIDS – TRIVETS

ST PAN 1/3	Third-Size Stainless Steel Pan – 12 ³ / ₄ "W x 6 ⁷ / ₈ "D x 2 ¹ / ₂ "H	\$ 64
ST PAN 1/2	Half-Size Stainless Steel Pan – 12 ³ / ₄ "W x 10 ³ / ₈ "D x 2 ¹ / ₂ "H	74
ST PAN 2	Full-Size Stainless Steel Pan – 12 ³ / ₄ "W x 20 ³ / ₄ "D x 2 ¹ / ₂ "H	88
ST PAN 4	Full-Size Stainless Steel Pan – 12 ³ / ₄ "W x 20 ³ / ₄ "D x 4"H	110
HDW 6" PAN	Full-Size Stainless Steel Pan – 12 ³ / ₄ "W x 20 ³ / ₄ "D x 6"H	120
4QT-PAN	4-Quart Round Pan	114
7QT-PAN	7-Quart Round Pan	127
11QT-PAN	11-Quart Round Pan	139
Notched Lid for Round Pans –		
4QT-LID-1	4-Quart Round, Notched, Solid Lid	\$54
7QT-LID-1	7-Quart Round, Notched, Solid Lid	66
11QT-LID-1	11-Quart Round, Notched, Solid Lid	79
Hinged Lid for Round Pans –		
4QT-LID	4-Quart Round, Hinged and Notched Lid	\$ 71
7QT-LID	7-Quart Round, Hinged and Notched Lid	93
11QT-LID	11-Quart Round, Hinged and Notched Lid	116
Wire Trivets Stainless –		
TRIVET (1/2)SS	Half-Size – 10 ¹ / ₆ "W x 7 ⁵ / ₈ "D	\$119
TRIVET SS	Full-Size – 10 ¹ / ₆ "W x 18"D	165

11QT-LID **4QT-PAN** **7QT-PAN**

7QT-LID **4QT-LID**

7QT-LID-1 **11QT-LID-1**

TRIVET (1/2)SS **TRIVET SS** **4QT-LID-1**

ADAPTERS, SUPPORT BARS, MOUNTING KITS, VALVES – PAGE 52

Drop-In Hot/Cold Well and Heated Well Accessories

(available for purchase at any time)

HWB-2-7Q
shown with two
7QT-PAN and
7QT-LID-1

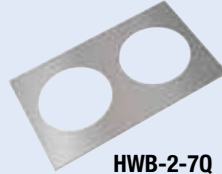

HWB-2-7Q



HWB-2-11Q



HWB-3-4Q

ADAPTERS – SUPPORT BARS

HWB-2-7Q	Adapter to convert warmer to hold two 7-Quart Inserts (HWB and HWBI Rectangular, HWBI and HWBI-S Modular Heated Wells only)	\$ 98
HWB-3-4Q	Adapter to convert warmer to hold three 4-Quart Inserts (HWB and HWBI Rectangular, HWBI and HWBI-S Modular Heated Wells only)	98
HWB-2-11Q	Adapter to convert warmer to hold two 11-Quart Inserts (HWB-43 Rectangular and HWBI43 Modular Heated Wells only)	123
HWB12BAR	12" Pan Support Bar for Built-In and Drop-In Heated Wells	21
HWB20BAR	20" Pan Support Bar for Built-In and Drop-In Heated Wells (not available for HWBI-43 series)	25
HWBGM12BAR	12" Pan Support Bar for Drop-In Modular/Ganged Models	21
HWBGM20BAR	20" Pan Support Bar for Drop-In Modular/Ganged Models (not available for HWBI43 series)	25

Support Bars
Choose the appropriate kit for HWBI or HWB series

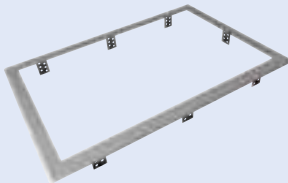
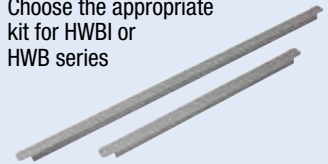

HWB-FUL-MNT
Choose the appropriate kit for HWB-FUL, HWB-43 or HWB-4Q, -7Q, -11Q series



HWB-MNT-REC or
HWB-MNT-RND



HWBI2MANIF



BALLVALVE1INCH

MOUNTING KITS – VALVES

Necessary at your Well Installation –

HWB-FUL-MNT	Mounting Kit for combustible countertops for HWB-FUL series only	\$126
HWB-43-MNT	Mounting Kit for combustible countertops for HWB-43 series only	151
HWB-4Q-MNT	Mounting Kit for combustible countertops for HWB-4Q series only	75
HWB-7Q-MNT	Mounting Kit for combustible countertops for HWB-7Q series only	82
HWB-11Q-MNT	Mounting Kit for combustible countertops for HWB-11Q series only	89

	Kit allows mounting to thick countertops - 8 Brackets (HWBI and HWB Rectangular Heated Wells, HWBI Modular Heated Wells only)	90
HWB-MNT-REC		
HWB-MNT-RND	Kit allows mounting to thick countertops - 4 Bracket (Round Heated Wells only)	45

External Manifold includes Individual Ball Valve for each Well (HWBI only, not available for the Slim models) –

HWBI2MANIF	2-Pan Accessory	\$ 930
HWBI3MANIF	3-Pan Accessory	1320
HWBI4MANIF	4-Pan Accessory	1709
HWBI5MANIF	5-Pan Accessory	2099
HWBI6MANIF	6-Pan Accessory	2489

Necessary at your Well Installation –

BALLVALVE3/4	High Temperature 3/4" NPT Ball Valve for units with Individual Drain(s) and no Manifold	\$117
BALLVALVE1INCH	High Temperature 1" NPT Ball Valve for units with Manifold Drain (Ganged Heated Wells only)	90
GATEVALVE3/4IN	High Temperature 3/4" NPT Gate Valve for units with Individual Drain(s) and no Manifold	135
GATEVALVE1INCH	High Temperature 1" NPT Gate Valve for units with Manifold Drain (Ganged Heated Wells only)	200
HWB-RDHV	Heated Well Remote Handle for 3/4" Drains only and includes a Ball Valve	463



GATEVALVE1INCH

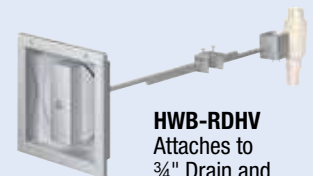

HWB-RDHV
Attaches to 3/4" Drain and includes a Ball Valve

Decorative Lamps & Display Lights

*Cafeterias • Convenience Stores
Supermarkets & Delis • Restaurants & Cafés
Clubs & Bars • Concessions*



DL-1100-SR in Clear Brushed Metal
Gloss finish *pg. 56-59*



DL-400-SN in Glossy Gray
Gloss finish *pg. 56-59*



DL-400-STR in Glossy Gray
Gloss finish *pg. 56-59*



DL-500-SR in Bright Brass
Plated finish *pg. 56-59*



DL-700-RL in Glossy Gray Gloss finish
(sneeze guards not available) *pg. 56-59*



DL-725-STR in Bright Nickel
Plated finish *pg. 56-59*



DL-750-STR in Bright Nickel
Plated finish *pg. 56-59*



HL5-60 in Standard Clear Anodized finish
(sneeze guards not available) *pg. 61*



(From left to right) DL-2300-ASN, -2200-SU, -2100-SR, -1800-RL, -2400-SU, -1600-CL and -1700-ASU

ORDERING INSTRUCTIONS

Luminaire lamps are for lighting only. LUMINAIRE option must be specified when lamps are utilized for decorative purposes only (no heating). This option is not field convertible. Maximum 100 watts.

CLEARANCE REQUIREMENTS

- NOTE:** Install Standard Watt (120V bulb, 250W) no closer than 3" from a sidewall and no closer than 16" above a combustible surface, or no closer than 5" to a non-combustible surface.
- NOTE:** Install HIGH WATT (120V, 375W bulb) no closer than 3" from a sidewall and no closer than 27" above a combustible surface, or no closer than 17" to a non-combustible surface.
- NOTE:** Multiple installation of Decorative Lamps must have a minimum clearance of 12" on center of shade between each unit.

Specify the following information with your order:

1. **Electrical:** Voltage 120V and Wattage 100 (Luminaire), 250 (Standard) or 375 (High)
2. **Mounting Style Code:** AS, AST, C, CT, R, RT, S, ST*
3. **Switch Location Code:** Lower (L), None (N), Remote (R) or Upper (U). DLH models must have remote switch or none
4. **Shade Style Code:** -400, -500, -600, -700, -725, -750, -760, -775, -800, -1100, -1400, -1500, -1600, -1700, -1800, -2100, -2200, -2300, -2400
5. **Shade and Canopy Colors:**
Warm Red, Black, Gray Granite, White Granite, Navy Blue, Hunter Green, Antique Copper, Smooth White, Gleaming Gold, Glossy Gray, Bold Black, Radiant Red* (lampshade only), Brilliant Blue* (lampshade only), Clear Coat Brushed Metal* (lampshade only), Bright Brass*, Bright Nickel*, Bright Copper*, Antique Nickel*, Antique Brass*, Antique Bronze*
6. **Overall Unit Length:** For C, CT, S, ST or AS, AST Mounts, from ceiling to bottom of warmer lamp shade
7. **Clearance:** From bulb to surface (see **NOTE** Clearance Requirements above)
8. **Accessory Bulb Color/Coating:**
40W Clear Coated (Luminaire only)
250W Clear Uncoated, Clear Coated, Red Uncoated or Red Coated
375W Clear Uncoated, Clear Coated
9. **Optional Cord/Track Color:** Black (standard), White (optional)

* Special process required and extended lead times, see page 58 for additional charge.
Specify your appropriate accessories with your order.
• Mounting Style availability dependent on Shade Style type. See page 56 & 57 for details.

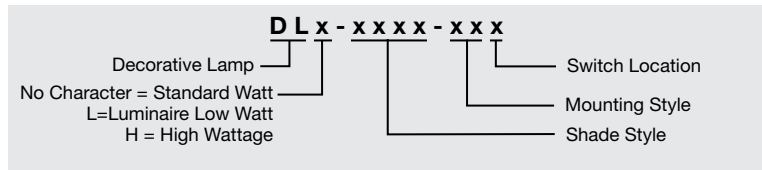
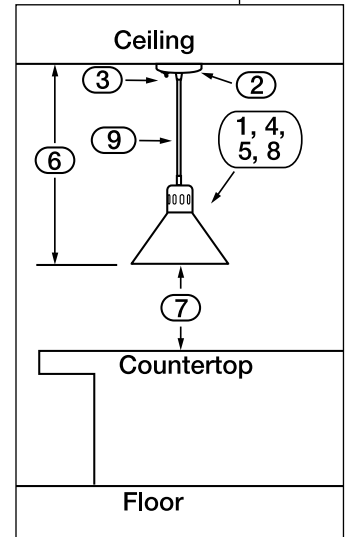

Decorative Lamps/ Luminaires

Hatco Decorative Lamps provide radiant heat to briefly hold food warm at kitchen work areas, wait staff pickup stations or customer serving points, while enhancing your décor. Versatile enough for any location, the range of lights are available with a selection of personalized choices: shade styles, colors, switch locations and mounting arrangements. Configurations for lighting (Luminaire), as well as foodwarming, are available.

NOTE: Decorative Lamps and Luminaires are non-returnable.

- Decorative Lamps and Luminaires available in nineteen shade styles
- Eight different mounting arrangements to choose from
- Seven *Designer* colors, seven Gloss finishes and six Plated finishes available
- Four power switch options:
Upper (on canopy)
Lower (at stem)
Remote
None
- Low, standard and high watt bulbs available (bulb not included in unit price)
- Available for food holding and display or lighting only applications

Rigid and Adjustable Stem Mounts in unit color (except for Gloss finishes Radiant Red, Brilliant Blue and Clear Brushed Metal)

Black cord is standard and white cord is optional. Various cord lengths available, starting at 17", while retractable can vary

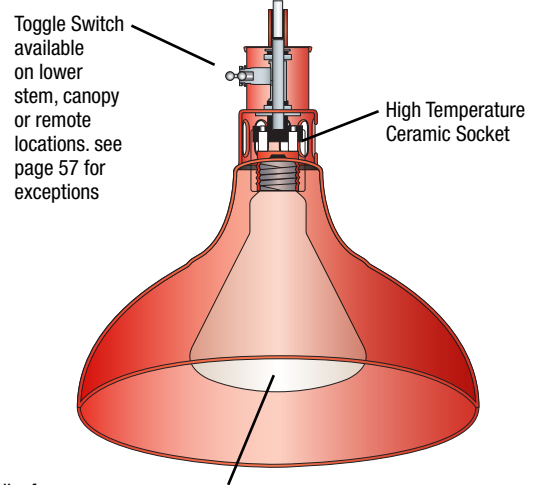

Bulbs for:
40W clear, coated (Luminaire only or DLL models)
250W (DL models) or 375W (DLH models) in clear, coated or uncoated
250W (DL models) red, uncoated or coated

Decorative Lamps & Display Lights

Build A Decorative Lamp

Hatco has given you a variety of simple and easy ways to "Build Your Decorative Lamp." You can go online or quickly do the work tables of "How to Build Your Lamp" on pages 56 through 59.

- GO online at: www.hatcocorp.com and click on "Build a Lamp" in the header. (Download a PDF of your lamp configuration in color and a Hatco List Price Quote)
- OR follow the six steps in the Hatco Price List (next four pages) to build your Hatco model code and List Price. Then look at the following page for the accessories, like a bulb or track, to easily complete your total order.



Hatco Website shown, click on "Build A Lamp" in the header to configure your choices



Now you can develop your own Hatco Decorative Lamp solutions with our online lamp configurator.

Visit www.hatcocorp.com
Click on "Build a Lamp"

HOW TO BUILD A LAMP

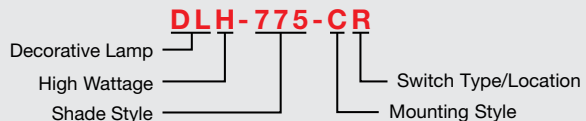

Specify the following options when ordering:

1 Electrical	DLH	(High Watt - 375 watt max)	No Charge
2 Mounting Style	C	(Cord Mount)	No Charge
3 Switch Location	R	(Remote Switch Location)	No Charge
4 Shade Style	-775	(See Shade Style on page 58)	\$460
Shade Color	BBRASS	(Bright Brass Plated Finish)	191
6 Overall Length	80"	(Overall Length) - Only C mounts & over 72"	24

(Specify to the nearest inch – CL, CU, CT, ASL, ASU, SL, SU, ST mounts only). **TOTAL \$675**
Information indicated in red are items that the customer must enter.
Bulbs are not included.



Build A Decorative Lamp Configurator Worksheet

Complete the six steps on this worksheet to configure your Hatco model code and List Price. In order to get exactly what you need in the least amount of time, have this handy when ordering your Hatco Decorative Lamp.



BUILD YOUR DECORATIVE/LUMINAIRE LAMPS – STEPS 1 AND 2
 (To determine your total list price and model code, pick all your options - bulb not included)

STEP 1: ELECTRICAL

Voltage	120	
Wattage –		No Charge
DLL- Luminaire	100 watt max	
DL- Standard	250 watt max	
DLH- High Watt	375 watt max	

STEP 2: MOUNTING STYLE

Mounting Style –		No Charge
C	Cord (specify Cord Color)	
	Cord Mount to Track Adapter	
CT *	(specify Cord and Track Color)	\$138
R	Retractable (specify Cord Color)	284
	Retractable Mount to Track Adapter (specify Cord and Track Color)	
RT *		419
S	Stem	77
ST *	Stem to Track Adapter	212

*** NOTE:** Lamp shade diameter and wattage may limit number of lamps per track. To ensure warranty coverage, do not install track systems in damp or wet locations (including above steam tables).

MOUNTING STYLES	SPECIFY:	Shade Height		
		8½" H	10½" H	
CORD	C Mount* Cord Mount to canopy. 	Overall Length	17" to any length	19" to any length
	CT Mount** Cord Mount to track adapter. 			
RETRACTABLE CORD	R Mount* Retractable Cord Mount. 	Adjusts to a maximum and minimum according to shade height	31" to 69½"	33" to 71½"
	RT Mount** Retractable Cord Mount to track adapter. 		33⅜" to 71⅞"	35⅜" to 73⅞"
STEM	S Mount* Rigid Stem Mount to canopy. 	Overall Length	14" to 71"	16" to 73"
	ST Mount** Rigid Stem Mount to track adapter. 		17" to 71"	19" to 73"
ADJUSTABLE	<p align="center">Go to next page to Continue Step 2 (Adjustable Stem Mounts) and for Step 3.</p>			

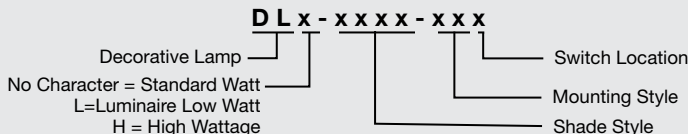

* Not available with a lower switch for DL-2100, -2200, -2300 or -2400
 ♦ Not available for DL-2100, -2200, -2300 or -2400

NOTE: Decorative Lamps and Luminaires are non-returnable.

Decorative Lamps & Display Lights

Build A Decorative Lamp Configurator Worksheet

Continued from page 56



Visit www.hatcocorp.com
Click on "Build a Lamp"

BUILD YOUR DECORATIVE/LUMINAIRE LAMPS – STEPS 2 AND 3 (To determine your total list price and model code, pick all your options - bulb not included)

MOUNTING STYLES	
Review Switch Locations below in Step 3 to determine your appropriate model code.	SPECIFY:
	Shade Height
	8½" H 10½" H
AS Mount* At install only, limited height adjustments with Rigid Stem Mount to canopy.	ASU, ASR, ASN
	14" to 16" 16" to 18" 16" to 19½" 18" to 21½" 20" to 27" 22" to 29" 27" to 42" 29" to 44" 42" to 72" 44" to 74"
	ASL
	16" to 17" 18" to 19" 18" to 22" 20" to 24" 22" to 28" 24" to 30" 29" to 43" 31" to 45" 44" to 73" 46" to 75"
AST* At install only, limited height adjustments with Rigid Stem Mount to track adapter.	ASTR, ASTN
	16" to 18" 18" to 20" 18" to 21" 20" to 23" 22" to 29" 24" to 31" 30" to 44" 32" to 46" 45" to 74" 47" to 76"
	ASTL
18" to 19" 20" to 21" 20" to 23" 22" to 25" 24" to 31" 26" to 33" 31" to 45" 33" to 47" 46" to 75" 48" to 77"	

*Not available with a lower switch for DL-2100, -2200, -2300 or -2400

STEP 2: MOUNTING STYLE – continued

Mounting Style –

AS	Adjustable Stem Mount (Limited height adjustment at install only, mount with rigid stem mount to canopy)	\$174
AST*	Adjustable Stem Track Mount (Limited height adjustment at install only, mount with rigid stem mount to track adapter)	298

*NOTE: Lamp shade diameter and wattage may limit number of lamps per track. To ensure warranty coverage, do not install track systems in damp or wet locations (including above steam tables).



Aluminum Plated Coupler provides a high strength hold for the Adjustable Stem Mount

Decorative Lamps & Display Lights

SWITCH LOCATIONS

L - Lower Switch
Not available on:
• DLH (high watt models)
• Not available for DL-2100, -2200, -2300 or -2400.

R - Remote Switch
• Accommodates 16 amps
• Up to seven 250W lamps, or five 375W lamps maximum per remote switch

U - Upper Switch
Not available on:
• DLH (high watt models)
• R Mount
• Track mounts (CT, RT, ST)

STEP 3: SWITCH LOCATION

Switch Location –	No Charge
L	Lower (not available on high watt models)
N	None
R	Remote
U	Upper (not available on high watt models)

Go to next page for Steps 4 and Steps 5.

NOTE: Decorative Lamps and Luminaires are non-returnable.

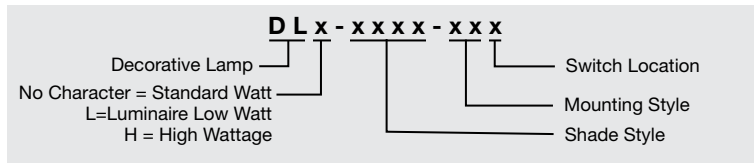

Build A Decorative Lamp Configurator Worksheet

Continued from page 57

BUILD YOUR DECORATIVE/LUMINAIRE LAMPS – STEPS 3 AND 4
 (To determine your total list price and model code, pick all your options - bulb not included)



Decorative Lamps & Display Lights

SHADE STYLES (height and width shown)

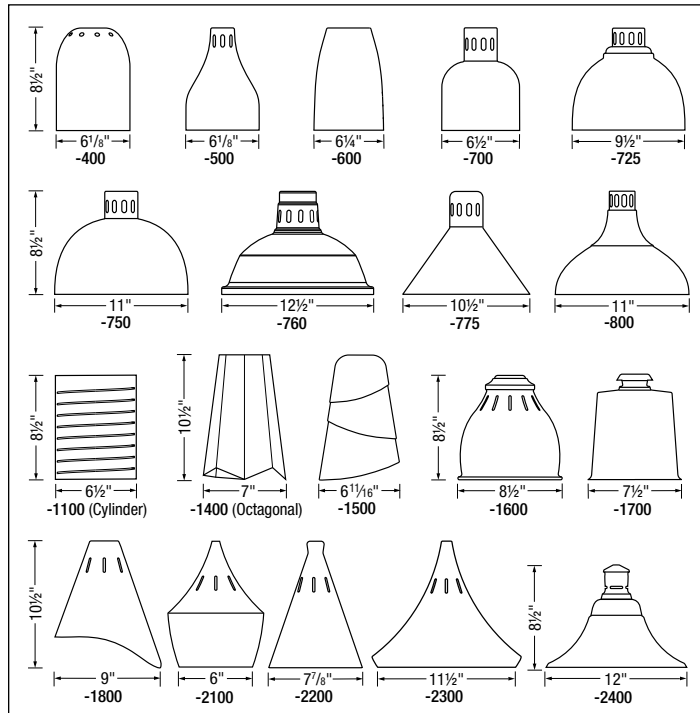

STEP 4: SHADE STYLE

Shade Code	Ship Weight <i>(depending on components)</i>	List Price
-400	6-10 lbs.	\$421
-500	6-10 lbs.	421
-600	6-10 lbs.	421
-700	6-10 lbs.	421
-725	6-10 lbs.	\$460
-750	6-10 lbs.	460
-760	6-10 lbs.	460
-775	6-10 lbs.	460
-800	6-10 lbs.	460
-1100	6-10 lbs.	460
-1400	6-10 lbs.	460
-1500	6-10 lbs.	\$524
-1600	6-10 lbs.	460
-1700	6-10 lbs.	460
-1800	6-10 lbs.	460
-2100	6-10 lbs.	\$401
-2200	6-10 lbs.	401
-2300	6-10 lbs.	401
-2400	6-10 lbs.	401

SHADE AND CANOPY COLORS

Designer Colors

Warm Red Black Gray Granite White Granite Navy Blue Hunter Green Antique Copper

Gloss Finishes

Smooth White Gleaming Gold Glossy Gray Bold Black

***Gloss Finishes for Shade Only – Special Process Required and Extended Lead Times**

Radiant Red Brilliant Blue Clear Brushed Metal

Printed colors are a representation and may not exactly match our Designer, Gloss and Plated Finishes.

STEP 5: SHADE AND CANOPY COLORS*

Designer Colors		No Charge
RED	Warm Red	NAVY Navy Blue
BLACK	Black	GREEN Hunter Green
GRAY	Gray Granite	COPPER Antique Copper
WHITE	White Granite	
Gloss Finishes		No Charge
SWHITE	Smooth White	GGRAY Glossy Gray
GGOLD	Gleaming Gold	BBLACK Bold Black

**Gloss Finishes for Shade Only – (must choose other finish for remainder of unit) – Special Process Required and Extended Lead Times –*

RRED	Radiant Red
BBLUE	Brilliant Blue
CL-COAT	Clear Brushed Metal

Go to next page to Continue Step 5 (Plated Finishes) and for Step 6.

NOTE: Decorative Lamps and Luminaires are non-returnable.

DLx - xxx - xxx

Decorative Lamp Switch Location
 No Character = Standard Watt Mounting Style
 L=Luminaire Low Watt Shade Style
 H = High Wattage

Build A Decorative Lamp Configurator Worksheet

Continued from page 58



Visit www.hatcocorp.com
Click on "Build a Lamp"

BUILD YOUR DECORATIVE/LUMINAIRE LAMPS – STEPS 5 AND 6
(To determine your total list price and model code, pick all your options - bulb not included)

STEP 5: SHADE AND CANOPY COLORS*

Plated Finishes –
Special Process Required and Extended Lead Times –

B BRASS	Bright Brass	\$191
B NICKEL	Bright Nickel	191
B COPPER	Bright Copper	191
A NICKEL	Antique Nickel	191
A BRASS	Antique Brass	191
A BRONZE	Antique Bronze	191

Plated Finishes – Special Process Required and Extended Lead Times



*Exception: DL-1500 for Shade Only –



*Gloss and Plated Finishes – Special Process Required and Extended Lead Times

Printed colors are a representation and may not exactly match our Designer, Gloss and Plated Finishes.

STEP 6: OVERALL LENGTH

Overall Length – For C or CT Mounts from ceiling to bottom of lamp shade.

Up to 72"	No Charge
Greater than 72" (C or CT Mount only)	\$24

Decorative Lamps & Display Lights

YOUR TOTAL LIST PRICE AND MODEL CODE

Add the total costs of options below (not for retrofit – bulb not included) –

Step 1	Electrical	\$ 0.00
Step 2	Mounting Style	<input type="text"/>
Step 3	Switch Location	0.00
Step 4	Shade Style	<input type="text"/>
Step 5	Shade and Canopy Colors	<input type="text"/>
Step 6	Overall Length	<input type="text"/>

Your Total Price \$

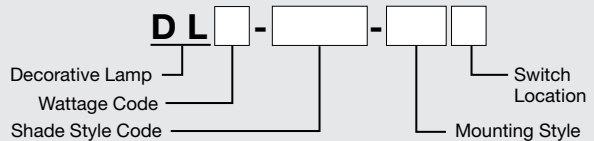

NOTE: Decorative Lamps and Luminaires are non-returnable.

BULBS AND ACCESSORIES – PAGE 60

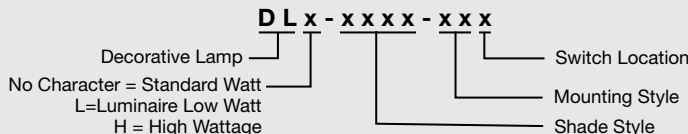



DL-750-STR in Bright Nickel finish

TRACK INSTALLATION AND MODIFICATION KIT – Highlighted components (for cutting Track Length into multiple sections)

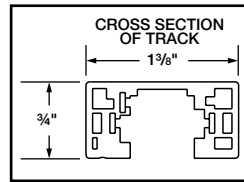
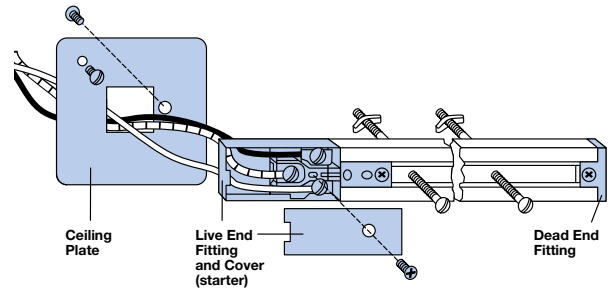

NOTE: Decorative Lamps and Luminaires are non-returnable.

OPTIONS (available at time of purchase only)

DL-CORD-BK	Black Cord – Standard (C=Cord, R=Retractable Mounts Only)	No Charge
DL-CORD-WHITE	White Cord (C=Cord, R=Retractable Mounts Only)	No Charge
Leads – For any Stem Mount or Adjustable Stem Mount unit, must specify Lead Length –		
LEADS5	1'-5' Extended Electrical Leads	\$ 27
LEADS10	6'-10' Extended Electrical Leads	54
LEADS15	11'-15' Extended Electrical Leads	81
LEADS20	16'-20' Extended Electrical Leads	108

ACCESSORIES (available for purchase at any time)

DL-TRACK-4B	4' Track Mount Bar, Black [‡]	\$285
DL-TRACK-4W	4' Track Mount Bar, White [‡]	285
DL-TRACK-8B	8' Track Mount Bar, Black [‡]	428
DL-TRACK-8W	8' Track Mount Bar, White [‡]	428
DL-TRACK-12B	One 8' plus one 4' Track Mount Bar with Coupler, Black [‡]	608
DL-TRACK-12W	One 8' plus one 4' Track Mount Bar with Coupler, White [‡]	608
DL-TRACK-16B	Two 8' Track Mount Bars with Coupler, Black [‡]	751
DL-TRACK-16W	Two 8' Track Mount Bars with Coupler, White [‡]	751
DL-TRACKBLK	Additional Track Installation and Modification Kit (includes Ceiling Plate, Live End Fitting and Cover (Starter) and Dead End Fitting) – Black (For cutting Track Length into multiple sections, see above)	114
DL-TRACKWHT	Additional Track Installation and Modification Kit (includes Ceiling Plate, Live End Fitting and Cover (Starter) and Dead End Fitting) – White (For cutting Track Length into multiple sections, see above)	114
DL-SWITCH-16AMP	16 Amp Lamp Toggle Switch	each 22
WHITE-CTD-120L	120 Volt, 40 Watt Clear Bulb, Coated (Luminaire models only)	each 16
WHITE-UCTD-120	120 Volt, 250 Watt Clear Bulb, Uncoated	each 26
WHITE-UCTD-120H	120 Volt, 375 Watt Clear Bulb, Uncoated (high watt models only)	each 47
WHITE-CTD-120	120 Volt, 250 Watt Clear Bulb, Coated	each 38
WHITE-CTD-120H	120 Volt, 375 Watt Clear Bulb, Coated (high watt models only)	each 61
RED-UCTD-120	120 Volt, 250 Watt Red Bulb, Uncoated	each 37
RED-CTD-120	120 Volt, 250 Watt Red Bulb, Coated	each 47

[‡] Tracks may be cut to fit any length by installer. Modification kits available.

[†] Maximum seven (7) 250 watt lamps or five (5) 375 watt lamps per 20 amp Track Bar Circuit. Maximum 1920 watts or 16 amps per any length track. Installer is responsible for properly sizing the supply circuit and the lamp load. Lamp shade diameter and wattage may limit number of lamps per track.

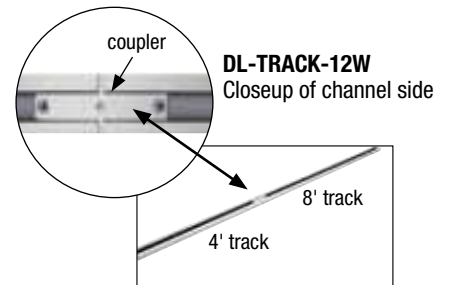

RED uncoated, **WHITE** uncoated, **RED** coated, **WHITE** coated



Glo-Rite® Curved Display Lights

A stylish choice for illuminating your serving area. The Glo-Rite® Curved Display Light offers the highest light output that is ideal for illuminating food products with either a warm white light (3050K) or a cool or neutral white light (4100K).

Hatco provides you with a wide variety of colors and lengths for any serving area.

- Features a patented curved housing design with energy efficient dual LED lights across the display lamp that provide longer performance and energy savings (compared to standard incandescent bulbs)
- Lengths available from 18"-72" in 6" increments
- Field replaceable dual LED lights
- Matches the Hatco line of Glo-Ray® Curved Infrared Strip Heaters for a fully integrated look
- Angle brackets and 6" LED leads are standard
- Optional non-adjustable tubular stands and top or bottom mounting stands available

HL5-36
Clear Anodized (standard) shown in top and underside views

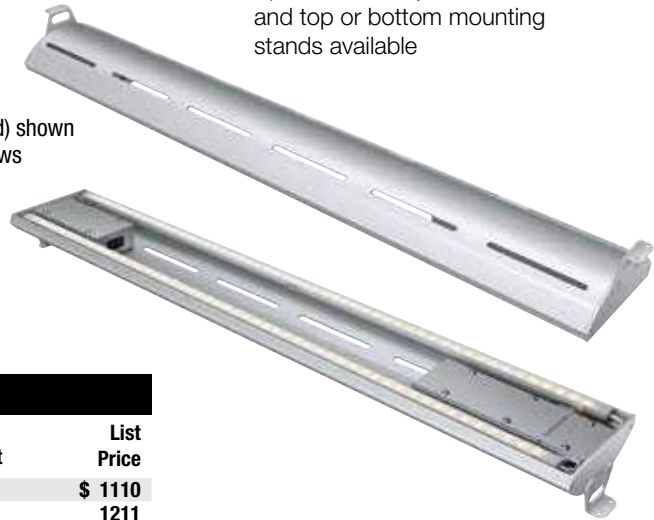

Decorative Lamps & Display Lights

GLO-RITE® CURVED DISPLAY LIGHTS

Model	Width	Voltage Single Phase	Watts	Ship Weight	List Price
HL5-18	18"	120	4.3	9 lbs.	\$ 1110
HL5-24	24"	120	5.9	12 lbs.	1211
HL5-30	30"	120	7.6	12 lbs.	1312
HL5-36	36"	120	9.2	12 lbs.	1413
HL5-42	42"	120	10.8	14 lbs.	1514
HL5-48	48"	120	12.4	16 lbs.	1615
HL5-54	54"	120	14.0	17 lbs.	1716
HL5-60	60"	120	15.7	18 lbs.	1817
HL5-66	66"	120	17.3	19 lbs.	1918
HL5-72	72"	120	18.9	20 lbs.	2019

All Curved Display Light Models Feature:

Voltage: 120, single phase.
Models Shipped with: End panels, angle brackets with rocker switch underunit on power side.
Leads: 6" leads - on power side.
Dimensions: 18"-72"W x 6"D x 3"H (height includes standard angle bracket).

OPTIONS (available at time of purchase only)

Designer Colors – Non-standard colors are non-returnable
Clear Anodized Standard –

RED	Warm Red	per foot \$32
BLACK	Black	per foot 32
GRAY	Gray Granite	per foot 32
WHITE	White Granite	per foot 32
NAVY	Navy Blue	per foot 32
GREEN	Hunter Green	per foot 32
COPPER	Antique Copper	per foot 32

Gloss Finishes – Non-standard colors are non-returnable

GGOLD	Gleaming Gold	per foot \$44
GGRAY	Glossy Gray	per foot 44
BBLACK	Bold Black	per foot 44
RRED	Radiant Red	per foot 44
BBLUE	Brilliant Blue	per foot 44

LED Light –

HL5-3050	Warm White (3050K)	Standard
HL5-4100	Cool or Neutral White (4100K)	No Charge

OPTIONS (available at time of purchase only)

LED Leads (must specify LED Lead Length) –

HL5-LEAD5	5' total LED Lead Length (includes a 3' conduit)	\$37
HL5-LEAD6	6' total LED Lead Length (includes a 3' conduit)	47
HL5-LEAD7	7' total LED Lead Length (includes a 3' conduit)	57
HL5-LEAD8	8' total LED Lead Length (includes a 3' conduit)	67
HL5-LEAD9	9' total LED Lead Length (includes a 3' conduit)	77
HL5-LEAD10	10' total LED Lead Length (includes a 3' conduit)	87
HL5-CORD	6' Cord with Plug (NEMA 5-15P)	37

Non-Adjustable Anodized Stands – Clear Anodized Standard

Bottom Mount Leg –

NTL5-10, -12	Tubular stands (specify 10" or 12" clearance)	1 pair \$166
NTL5-14, -16	Tubular stands (specify 14" or 16" clearance)	1 pair 207

Side Mount Leg –

SNTL5-10T, -12T	Top mounting stand (specify 10" or 12" clearance)	\$223
SNTL5-14T, -16T	Top mounting stand (specify 14" or 16" clearance)	254
SNTL5-10B, -12B	Bottom mounting stand (specify 10" or 12" clearance)	223
SNTL5-14B, -16B	Bottom mounting stand (specify 14" or 16" clearance)	254

Designer color or Gloss Finish for Non-Adjustable Tubular Stands–

NTL5-PAINT	Non-standard colors are non-returnable –	1 pair 46
-------------------	--	------------------

HL5 - x x

Glo-Rite Curved Display Light Width (Inches)
Aluminum Housing

COLORS AND FINISHES – INSIDE BACK COVER

Glo-Rite® Display Lights

Let the light shine on your work surface or display areas with the Glo-Rite® Display Lights. Durable and effective, Hatco light strips are made of extruded aluminum housings with bright-annealed reflectors for maximum brightness.

- Incandescent bulbs with special protective coating to guard against food contamination
- Extra lamps available on models from 24" to 72"
- Optional *Designer* colors: Warm Red, Black, Gray Granite, White Granite, Navy Blue, Hunter Green, Antique Copper



HL-24-2 including extra lamp assembly with lamps on 12" centers standard

Quick-Ship Model pages 241-247

Decorative Lamps & Display Lights

GLO-RITE DISPLAY LIGHTS

Model	Voltage Single Phase	No. of Bulbs	Width	Watts*	Ship Weight	List Price
✓ HL-18	120	2	18"	120	6 lbs.	\$ 398
✓ HL-24	120	2	24"	120	7 lbs.	421
HL-24-2	120	3	24"	180	6 lbs.	477
HL-30	120	2	30"	120	7 lbs.	444
HL-30-2	120	4	30"	240	8 lbs.	528
✓ HL-36	120	3	36"	180	8 lbs.	507
HL-36-2	120	5	36"	300	9 lbs.	600
HL-42	120	3	42"	180	10 lbs.	530
HL-42-2	120	6	42"	360	10 lbs.	650
✓ HL-48	120	4	48"	240	11 lbs.	593
HL-48-2	120	7	48"	420	12 lbs.	722
HL-54	120	4	54"	240	12 lbs.	616
HL-54-2	120	8	54"	480	13 lbs.	772
✓ HL-60	120	5	60"	300	13 lbs.	679
HL-60-2	120	9	60"	540	13 lbs.	844
HL-66	120	5	66"	300	14 lbs.	759
HL-66-2	120	10	66"	600	15 lbs.	944
HL-72	120	6	72"	360	18 lbs.	839
HL-72-2	120	10	72"	600	22 lbs.	1036

* Rated at 60 watt but comes with 40 watt incandescent bulb.

All Display Light Models Feature:

Toggle Switch (max. 15 amps) Location: Chef's left side (unless otherwise specified).

Leads: 6" leads – server's right.

Dimensions: 3"D x 2½"H.

OPTIONS (available at time of purchase only)

HAL	60 watt Halogen Bulb in lieu of standard Display Light	each \$63
NO BULB	No Bulb	No Charge
REM TOG	Remote Toggle Switch (max. 15 amps)	No Charge

Leads (must specify Lead Length) –

LEADS5	1'-5' Extended Electrical Leads	\$ 27
LEADS10	6'-10' Extended Electrical Leads	54
LEADS15	11'-15' Extended Electrical Leads	81
LEADS20	16'-20' Extended Electrical Leads	108

ACCESSORIES (available for purchase at any time)

HL-BRKT	Adjustable Angle Bracket	pair \$ 30
---------	--------------------------	------------

CHEF Bulbs (120V) adjustable bulb – Bulbs must be rotated down –

CLED-2700-120	Chef LED Bulb (similar to warm Incandescent light)	each 129
CLED-3000-120	Chef LED Bulb (similar to warm Halogen light)	each 129
CLED-4000-120	Chef LED Bulb (similar to cool Fluorescent light)	each 129

COLORS AND FINISHES – INSIDE BACK COVER

OPTIONS (available at time of purchase only)

Designer Colors – Non-standard colors are non-returnable –

RED	Warm Red	per foot \$32
BLACK	Black	per foot 32
GRAY	Gray Granite	per foot 32
WHITE	White Granite	per foot 32
NAVY	Navy Blue	per foot 32
GREEN	Hunter Green	per foot 32
COPPER	Antique Copper	per foot 32

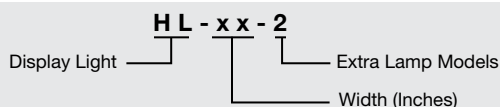
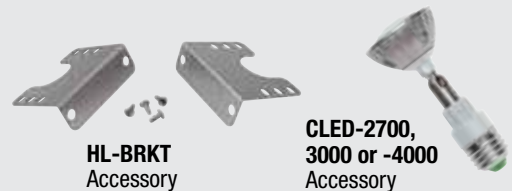



Save money lighting your
Hatco Glo-Ray® Strip Heater



GREEN ENERGY



Commit to going green in your foodservice operation with Hatco's patented Chef LED Bulbs! Heat strengthened glass lens protects the Light Emitting Diode (LED) while the exterior is made of rugged aluminum and prevents breakage of the components due to incidental contact in a busy kitchen environment. A Chef LED Bulb has substantial benefits and energy savings over other bulbs and are directional, so you can adjust it to your ideal setting.



Other features include:

- Designed to operate in high temperature areas
- Unique design allows operation over a steam table
- Illuminates instantly and can be rotated to showcase food product below
- Average of 184% increased light output, based on Foot Candle average delivered to surface from a height of 12" vs. 40 watt incandescent bulb
- Up to 91% energy savings vs. 40 watt incandescent bulb

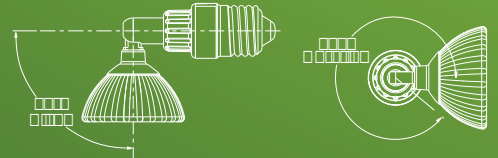

Go to www.hatcocorp.com and download the LED Cost Savings & Energy Analysis calculator to review your energy savings potential.



Scan to see how easy it is to install the Chef LED bulb, and direct the light, in your foodwarmer.



CLED-2700
(Warm Light)

3.5 watt

25,000 Hours*

Closest kelvin
Incandescent



CLED-3000
(Warm Light)

3.5 watt

25,000 Hours*

Closest kelvin
Halogen



CLED-4000
(Cool Light)

3.5 watt

25,000 Hours*

Closest kelvin
Fluorescent Tube

BULB:
Halogen

60 watt

1,500 Hours

BULB:
Incandescent*

40 watt

3,000 Hours

*Appliance bulb

* With 167°F ambient air temperature.

Used in HL, GRAL, GRAHL, GRAL-xxD, GRAHL-xxD, GRAIHL, GRAML, GR2AL, GR2AHL, GR2AL-xxD, GR2AHL-xxD, UGAL, UGAHL, UGAL-xxD, and UGAHL-xxD models.
Please contact factory for the most up-to-date listing of models that can use Chef LED Bulbs.

Strip Heaters

*Cafeterias • Buffets • Supermarkets & Delis
Restaurants & Cafés • Clubs & Bars*



GR5AL-60 in optional Radiant Red Gloss Finish above a **GRSB-54-1** *pg. 68*



GRAL-48 *pg. 71*



GRAH-42D with optional 6" spacer and optional non-adjustable tubular stands *pg. 73*



GRAML-60D with optional non-adjustable tubular stands *pg. 79*



GRNH-48 with standard Angle brackets and optional *Designer Warm Red* (Sneeze Guards as shown not available) *pg. 81*



GRAIHL-48, requires Remote Control Enclosure (RMB) *pg. 83*



GR2AHL-84 with optional *Designer Black* housing and Sneeze Guards *pg. 87*



UGA-24D in optional Radiant Red Gloss Finish *pg. 92*



UGAH-36D with Standard 3" spacer *pg. 92*

Ordering Instructions – Watch *How To Order A Hatco Strip Heater* on Hatco's website under Resources, Video Library

QUICK GUIDE – SOLUTIONS FOR ANY CLEARANCE – Detailed mounting and spacing requirements found on page 94

NARROW CLEARANCE

Infra-Black®

- Provides a very even and thermostatically controlled heat source
- For applications where the distance from the heat source to the target is narrow

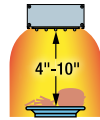

STANDARD CLEARANCE

Infrared Metal Sheathed Element:

- Pre-focused heat pattern directs infrared heat to the holding area
- Uniform heat distribution
- Energy efficient
- A wide variety of sizes and features available
- Our most popular solution

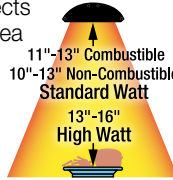

HIGH CLEARANCE

Ultra-Glo® Durable Ceramic Element

- Stronger, more intense heat source
- For applications where there is a greater distance between the heat source and target surface
- Ideal for French fry station applications

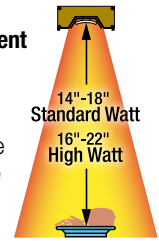

GR5AL-36 or GR5AHL-36



GR5A-36 or GR5AH-36

Glo-Ray® Curved Infrared Strip Heaters: (pages 67-69)

1. Choose a length
2. Standard or high watt
3. Lights or no lights
4. Voltage: 120, 208, 240
5. Choose control option for GR5A and GR5AH (GR5AL, GR5AHL have Remote Control Enclosure included)



GRA-72, GRAH-72 or GRAM-72



GRA-72D, GRAH-72D or GRAM-72D



GRAL-72, GRAHL-72 or GRAML-72



GRAL-72D, GRAHL-72D or GRAML-72D

Glo-Ray® Infrared Metal-Sheathed Strip Heaters: (pages 70-80)

1. Choose a length
2. Single or dual warmer
3. Standard, high or max watt
4. Lights or no lights
5. Voltage: 120, 208, 240 without lights or 120, 240, 120/208, 120/240 for units with lights
6. Choose control option, remote installation recommended (required on some models)*

GR-36 or GRH-36



Glo-Ray® Infrared Stainless Steel Strip Heaters: (pages 71-72)

1. Choose a length
2. Standard or high watt
3. Voltage: 120, 208 or 240
4. Choose control option, remote installation is recommended*

GRN-24, GRNH-24 or GRNM-24



Glo-Ray® Narrow Infrared Strip Heaters: (page 81-82)

1. Choose a length
2. Standard, high or max watt
3. Voltage: 120, 208, 240
4. Choose control option, remote installation is recommended*

* Multiple Strip Heaters may be connected to one RMB2 if the combined Amp draw of the warmers are less than the rating for the RMB2.

Strip Heaters

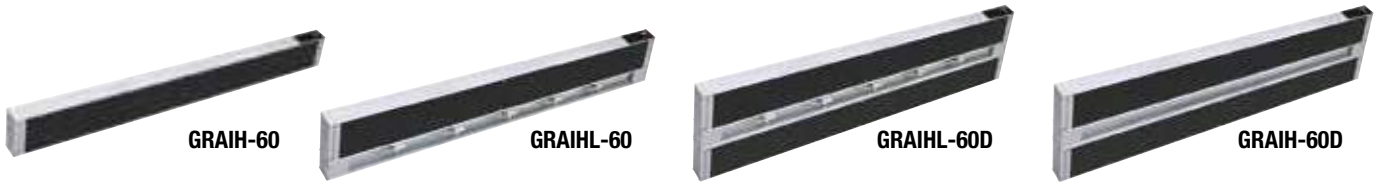

Glo-Ray® Infra-Black® Strip Heaters: (pages 83-85)

1. Choose a length
2. Single or dual warmer
3. Lights or no lights
4. Voltage: 120, 208, 240 without lights or 120/208, 120/240 for units with lights
5. Choose control option, remote installation is recommended*



Glo-Ray® Designer Infrared Strip Heaters: (pages 86-90)

1. Choose a length
2. Single or dual warmer
3. Standard or high watt
4. Lights or no lights
5. Voltage: 120, 208, 240 without lights or 120/208, 120/240 for units with lights
6. Choose control option, remote installation only*
7. Choose inset panel and corner cap color
8. Select Non-adjustable Stand Length or optional Overhead Mount (shown)

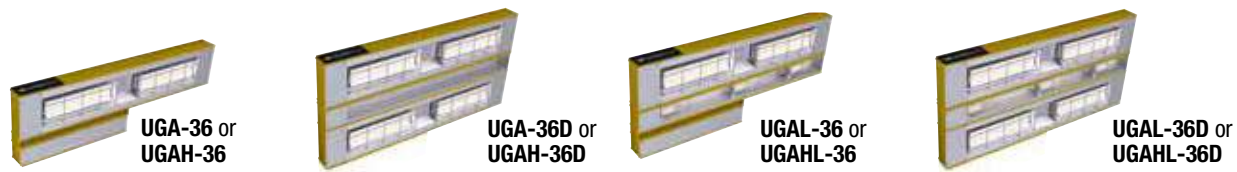

Ultra-Glo® Ceramic Strip Heaters: (pages 91-93)

1. Choose a length
2. Single or dual warmer
3. Standard or high watt
4. Lights or no lights
5. Voltage: 120, 208, 240 without lights or 120/208, 120/240 for units with lights
6. Choose control option, remote installation is recommended*

* Multiple Strip Heaters may be connected to one RMB2 if the combined Amp draw of the warmers are less than the rating for the RMB2.

Power and Switch Location

Each Strip Heater has specific Power and Switch locations (sample below). For information on other models, visit the *Document Library* under *Resources* on hatcocorp.com, and search *Power Locations*.

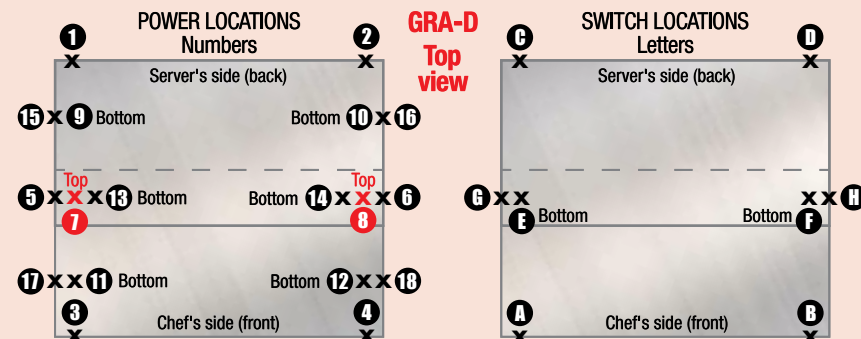

POWER: Numbers indicate potential power locations. Locations 9, 10, 11 and 12 are on the bottom of the warmer and are intended to be used in conjunction with the optional legs supplied by Hatco. Note: Maximum of 3 circuits down the leg. **SWITCH:** Letters indicate the potential control locations.

NOTE: Remote controls are available and recommended.

Typical Conduit Connection

Glo-Ray® Strip Heaters come standard with right angle attached 3' conduit and 42" leads on back of unit.

Narrow Strip Heaters have standard 6" leads, no conduit.

GR2A models - conduit exits non-adjustable stand or overhead mount only. GR5AL models have a 5' leadwire, which is 2' past the 3' conduit.

Ultra Glo® models - conduit exits through attached control box; if no control box, conduit exits side of unit.



Glo-Ray® Curved Infrared Strip Heaters

This stylish, patented design, based on our signature Glo-Ray Strip Heaters, is the perfect solution for your front-of-the-house applications. Superb for buffet and serving lines, the sleek curved design minimizes its size while accenting and warming the products below.

The entire holding surface is heated evenly with no “cold” spots thanks to Hatco's dependable infrared element technology.

- Narrow, curved design: 2"H x 6"D uses a very small footprint
- Lengths available from 18"-72" in 6" increments
- Patented housing design
- Angle brackets (mounting) are standard

- Pre-focused heat maintains safe serving temperatures longer without continuing to cook the food
- Available in standard or high watt
- End panels and mounting brackets match unit color
- Hatco's wide array of colors help provide the right look for your venue

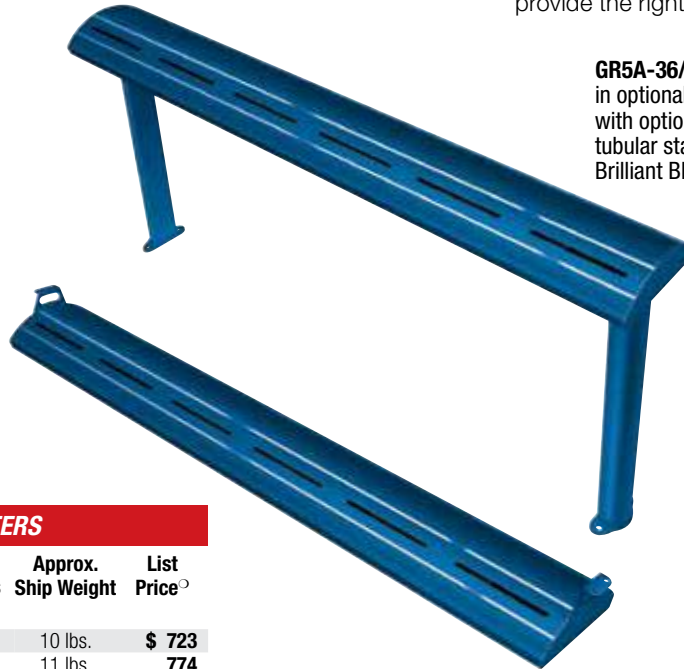

GR5A-36/GR5AH-36
in optional Brilliant Blue Gloss Finish with standard Angle Brackets

GR5A-36/GR5AH-36
in optional Brilliant Blue Gloss Finish with optional 16" non-adjustable tubular stands (legs) in optional Brilliant Blue Gloss Finish

GLO-RAY CURVED INFRARED STRIP HEATERS

Model	Width	Voltage Single Phase	Watts	Approx. Ship Weight	List Price ^o
Standard Watt					
GR5A-18	18"	120, 208 or 240	250	10 lbs.	\$ 723
GR5A-24	24"	120, 208 or 240	350	11 lbs.	774
GR5A-30	30"	120, 208 or 240	450	12 lbs.	825
GR5A-36	36"	120, 208 or 240	575	12 lbs.	876
GR5A-42	42"	120, 208 or 240	675	13 lbs.	927
GR5A-48	48"	120, 208 or 240	800	15 lbs.	978
GR5A-54	54"	120, 208 or 240	925	17 lbs.	1029
GR5A-60	60"	120, 208 or 240	1050	20 lbs.	1080
GR5A-66	66"	120, 208 or 240	1160	25 lbs.	1131
GR5A-72	72"	120, 208 or 240	1275	25 lbs.	1182
High Watt					
GR5AH-18	18"	120, 208 or 240	350	10 lbs.	\$ 731
GR5AH-24	24"	120, 208 or 240	500	11 lbs.	782
GR5AH-30	30"	120, 208 or 240	660	12 lbs.	833
GR5AH-36	36"	120, 208 or 240	800	12 lbs.	884
GR5AH-42	42"	120, 208 or 240	950	13 lbs.	935
GR5AH-48	48"	120, 208 or 240	1100	15 lbs.	986
GR5AH-54	54"	120, 208 or 240	1250	17 lbs.	1037
GR5AH-60	60"	120, 208 or 240	1400	20 lbs.	1088
GR5AH-66*	66"	120, 208 or 240	1560	25 lbs.	1139
GR5AH-72*	72"	120, 208 or 240	1725	25 lbs.	1190

^o Does not include Remote Control Enclosure (RMB), see pages 69, 96 and 97.

* Infinite switch not available on 120V.

All Glo-Ray Curved Infrared Models Feature:

Leads: 3' conduit, 5' Power Leads.

Angle Brackets: Provides 1" clearance between Strip Heater and overshelf.

Dimensions: 18"-72"W x 6"D x 2"H.

OPTIONS AND ACCESSORIES – PAGE 69
RECOMMENDED MOUNTING HEIGHTS – PAGE 94
COLORS AND FINISHES – INSIDE BACK COVER

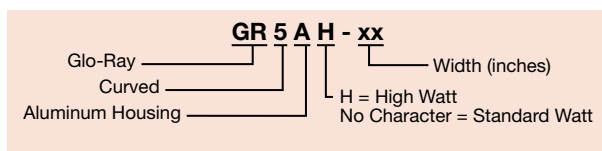

Strip Heaters



Glo-Ray® Curved Infrared Strip Heaters with LED Lights

Hatco's Glo-Ray Curved Infrared Strip Heaters with LED Lights feature a patented housing design that is low-profile, elliptical-shaped and stylish, the ideal solution for front-of-the-house applications where heat and/or lights are needed.

It can operate with just the dual LED lights; or the dual LED lights can be used simultaneously with the infrared emitter to provide the perfect balance of light and heat.

- Narrow, curved design: 2"H x 6"D uses a very small footprint with lengths available from 18"-72" in 6" increments
- Patented housing design has energy efficient dual LED lights across the entire strip heater, which provide longer performance and energy savings (compared to standard incandescent bulbs - 3.5 to 15.2 watts based on length)
- Angle brackets (mounting) are standard
- Pre-focused heat maintains safe serving temperatures longer without continuing to cook the food
- Can be used with lights only or heat only
- 100% linear infinite controls with adjustability from 0-100%, allow for precise settings
- Field replaceable LED available as:
 - Warm White* (standard)
 - Neutral (Cool) White*
 - Dual Color: Warm White/Neutral (Cool) White* (toggle between color temperatures to enhance foods displayed)
- Electronic Infinite Control Remote Box and power On/Off switch (controls lights, heat) included
- Available as lights only (see HL5 series in Decorative Lamps & Display Lights section)

GR5AL-36/GR5AHL-36
Top and bottom view.
Shown in optional Radiant Red Gloss Finish and standard Angle Brackets



GLO-RAY CURVED INFRARED STRIP HEATERS with LED LIGHTS

Model	Width	Voltage Single Phase	Watts	Approx. Ship Weight	List Price
Standard Watt					
GR5AL-18	18"	120, 208 or 240	254	16 lbs.	\$2399
GR5AL-24	24"	120, 208 or 240	356	18 lbs.	2536
GR5AL-30	30"	120, 208 or 240	458	23 lbs.	2673
GR5AL-36	36"	120, 208 or 240	584	21 lbs.	2810
GR5AL-42	42"	120, 208 or 240	686	24 lbs.	2947
GR5AL-48	48"	120, 208 or 240	812	24 lbs.	3084
GR5AL-54	54"	120, 208 or 240	939	28 lbs.	3221
GR5AL-60	60"	120, 208 or 240	1066	28 lbs.	3358
GR5AL-66	66"	120, 208 or 240	1177	36 lbs.	3495
GR5AL-72	72"	120, 208 or 240	1294	30 lbs.	3632
High Watt					
GR5AHL-18	18"	120, 208 or 240	354	16 lbs.	\$2407
GR5AHL-24	24"	120, 208 or 240	506	17 lbs.	2544
GR5AHL-30	30"	120, 208 or 240	668	21 lbs.	2681
GR5AHL-36	36"	120, 208 or 240	809	21 lbs.	2818
GR5AHL-42	42"	120, 208 or 240	961	22 lbs.	2955
GR5AHL-48	48"	120, 208 or 240	1112	25 lbs.	3092
GR5AHL-54	54"	120, 208 or 240	1264	25 lbs.	3229
GR5AHL-60	60"	120, 208 or 240	1416	29 lbs.	3366
GR5AHL-66	66"	120, 208 or 240	1577	29 lbs.	3503
GR5AHL-72	72"	120, 208 or 240	1744	30 lbs.	3640

All Glo-Ray Curved Infrared with Lights Models Feature:

Switch Location: Remote box with electronic infinite control and power On/Off switch (controls lights and heat) included.

Leads: 3' conduit, 5' Power Leads, 6½' (78") LED Leads. standard LED lead length is 1½' (18") longer than Power Lead length.

Angle Brackets: Provides 1" clearance between strip heater and overself.

Dimensions: 18"-72"W x 6"D x 2"H. **Control Box Dimensions:** 11"W x 5½"H.

Cut Out Dim.: 10⅞"W x 6¼"D x 4¾"H.

OPTIONS AND ACCESSORIES – PAGE 69

RECOMMENDED MOUNTING HEIGHTS – PAGE 94

COLORS AND FINISHES – INSIDE BACK COVER

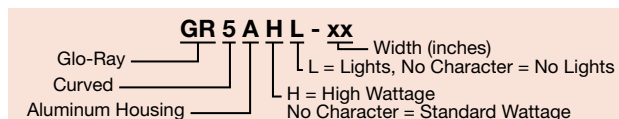

RECOMMENDED LIGHT USAGE

GR5A(H)L above...	Warm White*	Cool White*	Warm/Neutral (Cool) White*
Heated Well(s)	X		
Refrigerated Well(s)		X	
Heated Shelf (Shelves)	X		
Refrigerated Shelf (Shelves)		X	
Hot/Cold Well(s)			X
Hot/ Cold Shelf (Shelves)			X

* Warm White can range from 2700-3200K, Neutral (Cool) White from 4000-4300K



A **GR5AL** model in optional Radiant Red Gloss Finish above a **GRS-54**

OPTIONS (available at time of purchase only)

Designer Colors – End panels and Angle Brackets match unit color – Non-standard colors are non-returnable –					per foot \$32			
RED	Warm Red	BLACK	Black	GRAY	Gray Granite	COPPER	Antique Copper	
WHITE	White Granite	BLUE	Navy Blue	GREEN	Hunter Green			
Gloss Finishes – End panels and Angle Brackets match unit color – Non-standard colors are non-returnable –					per foot \$44			
GGOLD	Gleaming Gold	BBLUE	Brilliant Blue	GGRAY	Glossy Gray			
RRED	Radiant Red	BBLACK	Bold Black					
Non-Adjustable Tubular Stands – Clear Anodized standard –								
Bottom mount leg for bottom mount installation								
	NTL5-10, -12	Specify 10" or 12" clearance					1 pair	\$166
	NTL5-14, -16	Specify 14" or 16" clearance					1 pair	207
Side mount leg for bottom mount installation								
	SNTL5-10B, -12B	Specify 10" or 12" clearance					1 pair	\$223
	SNTL5-14B, -16B	Specify 14" or 16" clearance					1 pair	254
Side mount leg for top mount installation								
	SNTL5-10T, -12T	Specify 10" or 12" clearance					1 pair	\$223
	SNTL5-14T, -16T	Specify 14" or 16" clearance					1 pair	254
NTL5-PAINT	<i>Designer Color or Gloss Finish for Non-Adjustable Tubular Stands – Non-standard colors are non-returnable –</i>						1 pair	46
RED	Warm Red	GRAY	Gray Granite	NAVY	Navy Blue	COPPER	Antique Copper	
BLACK	Black	WHITE	White Granite	GREEN	Hunter Green			
RRED	Radiant Red	GGRAY	Glossy Gray	BBLACK	Bold Black			
GGOLD	Gleaming Gold	BBLUE	Brilliant Blue					
GR5AL-NW	Neutral (Cool) White LED – Neutral (Cool) White can range from 4000-4300K						No Charge	
GR5AL-WW/NW	Dual Warm/Neutral (Cool) White LED – Warm White can range from 2700-3200K, Neutral (Cool) White from 4000-4300K						\$342	
GR5AL-OPP	Power and LED wiring exit opposite ends of unit (Same end is the standard offering) – Must specify Power Lead length and LED Lead length required –						No Charge	
Power Wire Leads – GR5A(H) models– 5' Power Lead length standard –								
	GR5A-LEADS10	6'-10' total Power Lead length					\$27	
	GR5A-LEADS15	11'-15' total Power Lead length					54	
Power Wire Leads – GR5A(H)L models– 5' Power Lead length standard –								
	GR5AL-LEADS10	6'-10' total power Lead length					\$27	
	GR5AL-LEADS15	11'-15' total power Lead length					54	
LED Leads – 6½' (78") LED Lead length standard – Standard LED lead length is 1½' (18") longer than Power Lead length								
	LED-LEADS10	11½' (138") total LED Lead length					\$ 42	
	LED-LEADS15	16½' (198") total LED Lead length					84	
	LED-LEADS20	21½' (258") total LED Lead length					126	
NO CONTROL	GR5A(H) models only – No control included, requires selection of RMB2-xx control – page 96						No Charge	
REM INF	GR5A(H) models only – Remote Infinite Switches in lieu of Toggle (max. 12.2 Amps) –						each 47	
REM TOG	GR5A(H) models only – Remote Toggle Switches (max. 15 Amps) –						No Charge	
RMB	GR5A(H) models only – Remote Box – Available in <i>Designer Colors</i> or <i>Gloss Finishes</i> – see pages 97							
	Non-standard colors are non-returnable – Clear Anodized standard –							
RMB5-2R	Remote Box for GR5A(H)L models – Allows for up to two 72" wide units to be connected to a single control box at same set points – 14"W x 5 ¹⁵ / ₁₆ "D x 5 ¹ / ₂ "H (Cut out dimensions: 13 ¹ / ₈ "W x 4 ³ / ₄ "H)						\$1161	

RECOMMENDED MOUNTING HEIGHTS – PAGE 94
COLORS AND FINISHES – INSIDE BACK COVER

RMB5-2R





Glo-Ray® Aluminium Infrared Strip Heaters

Safely hold the temperature of your product without drying out or further cooking food with these Strip Heaters. The end result is hot, fresh food that's ready-to-serve. The continuous aluminum housing and heavy-duty mountings ensure the durability and quality of Hatco products. Heavy-duty Stainless Steel housings are available (next page).

- Ensures maximum flavor, safety and holding time
- Even heat distribution – no “cold spots”
- Sturdy extruded aluminum housings that do not sag, from 18" to 144" (12")
- Reflector does not blacken, maintaining a consistent heat pattern
- Heavy-duty insulation minimizes heat loss
- Optional Sneeze Guards (excludes Stainless Steel models)
- Available in Stainless Steel housing 18" to 96"
- Available with lights (shatter resistant incandescent lights or optional halogen lights - excludes Stainless Steel models)

- Pre-focused heat pattern bathes entire holding surface
- Additional reflector styles and lower wattage elements available, consult factory for more information



GRAH-36 High watt, toggle controlled with 2-S hooks, 2-6" chains (optional cord and plug attached)

Toggle Switch: Max. 15 Amps
Infinite Switch: Max. 12.2 Amps

Quick-Ship Model pages 241-247

ALUMINUM STRIP HEATERS with CONDUIT (Standard Watt)

Model	Width	Voltage Single Phase	Watts	Ship Weight	List Price ^o
Standard Watt					
✓ GRA-18	18"	120, 208 or 240	250	7 lbs.	\$ 325
✓ GRA-24	24"	120, 208 or 240	350	7 lbs.	342
✓ GRA-30	30"	120, 208 or 240	450	8 lbs.	366
✓ GRA-36	36"	120, 208 or 240	575	9 lbs.	389
✓ GRA-42	42"	120, 208 or 240	675	10 lbs.	413
✓ GRA-48	48"	120, 208 or 240	800	11 lbs.	439
✓ GRA-54	54"	120, 208 or 240	925	13 lbs.	467
✓ GRA-60	60"	120, 208 or 240	1050	14 lbs.	498
✓ GRA-66	66"	120, 208 or 240	1160	16 lbs.	548
✓ GRA-72	72"	120, 208 or 240	1275	17 lbs.	619
✓ GRA-84 ^v	84"	120, 208 or 240	1500	19 lbs.	716
✓ GRA-96 ^v	96"	120, 208 or 240	1725	21 lbs.	815
✓ GRA-108	108"	120, 208 or 240	1850	24 lbs.	1028
✓ GRA-120	120"	120, 208 or 240	2100	26 lbs.	1117
✓ GRA-132	132"	120, 208 or 240	2320	30 lbs.	1207
✓ GRA-144	144"	120, 208 or 240	2550	33 lbs.	1296

^o Does not include Remote Control Enclosure (RMB), see pages 96 and 97.
^v When using an infinite control with 120 volt model, additional switch(es) and tandem (end-to-end) elements are required, cord not available.
[^] 120 volt models require additional switches and tandem (end-to-end) elements.

All Glo-Ray Aluminium Infrared Models Feature:

Toggle Switch (max. 15 Amps) Location: Chef's left side (unless otherwise specified).
Leads: 3' conduit with leads – server's right. NEMA 5-15P cord available on 120 volt models 72" or less with C-leg, T-leg stand or chain-hook mount. GRAH-66 and GRAH-72 require NEMA 5-20P cord for Canada.
Dimensions: 18"-144"W x 6"D x 2½"H.

OPTIONS AND ACCESSORIES – PAGE 72
RECOMMENDED MOUNTING HEIGHTS – PAGE 94

ALUMINUM STRIP HEATERS with CONDUIT (High Watt)

Model	Width	Voltage Single Phase	Watts	Ship Weight	List Price ^o
High Watt					
✓ GRAH-18	18"	120, 208 or 240	350	7 lbs.	\$ 333
✓ GRAH-24	24"	120, 208 or 240	500	8 lbs.	350
✓ GRAH-30	30"	120, 208 or 240	660	8 lbs.	374
✓ GRAH-36	36"	120, 208 or 240	800	9 lbs.	397
✓ GRAH-42	42"	120, 208 or 240	950	11 lbs.	421
✓ GRAH-48	48"	120, 208 or 240	1100	11 lbs.	447
✓ GRAH-54	54"	120, 208 or 240	1250	13 lbs.	475
✓ GRAH-60	60"	120, 208 or 240	1400	14 lbs.	506
✓ GRAH-66 ^v	66"	120, 208 or 240	1560	16 lbs.	556
✓ GRAH-72 ^v	72"	120, 208 or 240	1725	17 lbs.	627
✓ GRAH-84 [^]	84"	120, 208 or 240	2050	19 lbs.	724
✓ GRAH-96 [^]	96"	120, 208 or 240	2400	21 lbs.	823
✓ GRAH-108	108"	120, 208 or 240	2500	23 lbs.	1036
✓ GRAH-120	120"	120, 208 or 240	2800	26 lbs.	1125
✓ GRAH-132	132"	120, 208 or 240	3120	31 lbs.	1215
✓ GRAH-144	144"	120, 208 or 240	3450	48 lbs.	1304

Quick-Ship Model pages 241-247

ALUMINUM STRIP HEATERS with S HOOKS, CHAINS and CORD and PLUG ATTACHED



Model	Item No.	Width	Voltage Single Phase	Watts	Ship Weight	List Price
Standard Watt – Toggle Controlled with S Hooks and Chain, Cord and Plug attached						
✓ GRA-24	GRA24120TCCS	24"	120	350	7 lbs.	\$393
✓ GRA-36	GRA36120TCCS	36"	120	575	9 lbs.	440
✓ GRA-48	GRA48120TCCS	48"	120	800	11 lbs.	490
✓ GRA-60	GRA60120TCCS	60"	120	1050	14 lbs.	549
High Watt – Toggle Controlled with S Hooks and Chain, Cord and Plug attached						
✓ GRAH-18	AH18120TCCS	18"	120	350	6 lbs.	\$384
✓ GRAH-24	AH24120TCCS	24"	120	500	7 lbs.	401
✓ GRAH-30	AH30120TCCS	30"	120	660	8 lbs.	425
✓ GRAH-36	AH36120TCCS	36"	120	800	9 lbs.	448
✓ GRAH-42	AH42120TCCS	42"	120	950	10 lbs.	472
✓ GRAH-48	AH48120TCCS	48"	120	1100	11 lbs.	498
✓ GRAH-60	AH60120TCCS	60"	120	1400	14 lbs.	557
✓ GRAH-72 ^s	AH72120TCCS.1	72"	120	1725	17 lbs.	678
High Watt – Infinite Controlled with S Hooks and Chain, Cord and Plug attached						
✓ GRAH-24	AH24120ICCS	24"	120	500	7 lbs.	\$448
✓ GRAH-36	AH36120ICCS	36"	120	800	9 lbs.	495
✓ GRAH-48	AH48120ICCS	48"	120	1100	11 lbs.	545
✓ GRAH-60	AH60120ICCS	60"	120	1400	14 lbs.	604

^s Not available for Canada

Strip Heaters

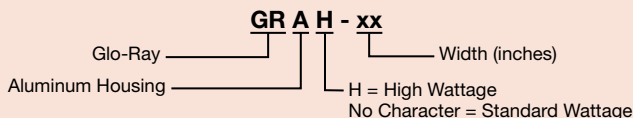



GRAHL-36 with optional Sneeze Guards and adjustable tubular stands

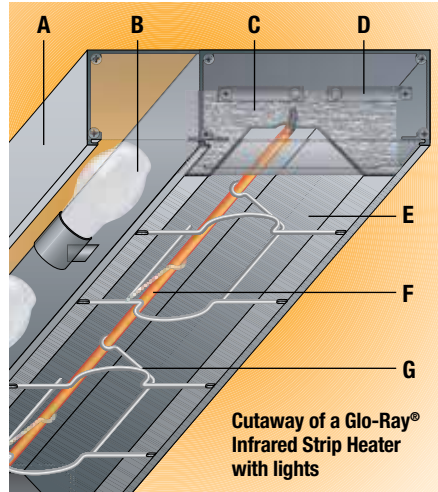

Cutaway of a Glo-Ray® Infrared Strip Heater with lights

- A** Stainless Steel or sturdy aluminum housings that do not sag, from 18" up to 144" (12') in 6" increments. Stainless Steel units available as single units without lights, up to 96" in width
- B** Shatter-resistant incandescent lights (standard on GRAL/GRAHL), optional halogen bulb available
- C** Heavy-duty insulation minimizes heat loss
- D** Standard Hanger Tabs are provided
- E** Aluminized reflector retains full heat intensity and directs more heat towards the edges of the holding surface
- F** Metal-sheathed heating element part guaranteed against burnout and breakage for two years
- G** Protective wire guard supports heating element without affecting heat distribution

Quick-Ship Model pages 241-247

ALUMINUM STRIP HEATERS with LIGHTS with CONDUIT

Model	Bulbs	Width	Voltage Single Phase	Watts	Ship Weight	List Price ^o
Standard Watt						
GRAL-18	2	18"	120, 120/208 or 120/240	370	9 lbs.	\$ 517
GRAL-24	2	24"	120, 120/208 or 120/240	470	10 lbs.	538
GRAL-30	2	30"	120, 120/208 or 120/240	570	12 lbs.	598
GRAL-36	3	36"	120, 120/208 or 120/240	755	13 lbs.	659
GRAL-42	3	42"	120, 120/208 or 120/240	855	15 lbs.	723
GRAL-48	4	48"	120, 120/208 or 120/240	1040	17 lbs.	786
GRAL-54	4	54"	120, 120/208 or 120/240	1165	19 lbs.	858
GRAL-60	5	60"	120, 120/208 or 120/240	1350	21 lbs.	933
GRAL-66	5	66"	120, 120/208 or 120/240	1460	22 lbs.	1021
GRAL-72	6	72"	120, 120/208 or 120/240	1635	24 lbs.	1138
GRAL-84 ^v	7	84"	120, 120/208 or 120/240	1920	28 lbs.	1315
GRAL-96 ^v	8	96"	120, 120/208 or 120/240	2205	32 lbs.	1492
GRAL-108	9	108"	120, 120/208 or 120/240	2390	36 lbs.	1796
GRAL-120	10	120"	120, 120/208 or 120/240	2700	40 lbs.	1970
GRAL-132	11	132"	120, 120/208 or 120/240	2980	44 lbs.	2145
GRAL-144	12	144"	120, 120/208 or 120/240	3270	48 lbs.	2323
High Watt						
GRAHL-18	2	18"	120, 120/208 or 120/240	470	8 lbs.	\$ 525
GRAHL-24	2	24"	120, 120/208 or 120/240	620	10 lbs.	546
GRAHL-30	2	30"	120, 120/208 or 120/240	780	11 lbs.	606
GRAHL-36	3	36"	120, 120/208 or 120/240	980	13 lbs.	667
GRAHL-42	3	42"	120, 120/208 or 120/240	1130	16 lbs.	731
GRAHL-48	4	48"	120, 120/208 or 120/240	1340	17 lbs.	794
GRAHL-54	4	54"	120, 120/208 or 120/240	1490	19 lbs.	866
GRAHL-60	5	60"	120, 120/208 or 120/240	1700	21 lbs.	941
GRAHL-66 ^v	5	66"	120, 120/208 or 120/240	1860	22 lbs.	1029
GRAHL-72 ^v	6	72"	120, 120/208 or 120/240	2085	34 lbs.	1146
GRAHL-84 [^]	7	84"	120, 120/208 or 120/240	2470	28 lbs.	1323
GRAHL-96 [^]	8	96"	120, 120/208 or 120/240	2880	53 lbs.	1500
GRAHL-108	9	108"	120, 120/208 or 120/240	3040	36 lbs.	1804
GRAHL-120	10	120"	120, 120/208 or 120/240	3400	40 lbs.	1978
GRAHL-132	11	132"	120, 120/208 or 120/240	3780	44 lbs.	2153
GRAHL-144	12	144"	120, 120/208 or 120/240	4170	48 lbs.	2331

^o Does not include Remote Control Enclosure (RMB), see pages 96 and 97.

^v When using an Infinite Control with 120 volt model, additional switch(es) and tandem (end-to-end) elements are required, cord not available.

[^] 120 volt models require additional switches and tandem (end-to-end) elements.

All Glo-Ray Aluminum Infrared Models with Conduit and Lights Feature:

Toggle Switch (max. 15 Amps) Location: Chef's left side – light side (unless otherwise specified).
Leads: 3' conduit with leads – server's right. NEMA 5-15P cord available on 120 volt models 72" or less with C-leg, T-leg stand or hook-chain mount. GRAHL-54, GRAHL-60, GRAL-66 & GRAL-72 require NEMA 5-20P cord for Canada. GRAHL-66 & GRAHL-72 require NEMA 5-20P cord - not available for Canada.

Dimensions: 18"-144"W x 9"D x 2 1/2"H.

OPTIONS AND ACCESSORIES – PAGE 72

RECOMMENDED MOUNTING HEIGHTS – PAGE 94

STAINLESS STEEL STRIP HEATERS with CONDUIT

Model	Width	Voltage Single Phase	Watts	Ship Weight	List Price ^o
Standard Watt					
GR-18	18"	120, 208 or 240	250	7 lbs.	\$ 481
GR-24	24"	120, 208 or 240	350	7 lbs.	506
GR-36	36"	120, 208 or 240	575	10 lbs.	572
GR-48	48"	120, 208 or 240	800	12 lbs.	622
GR-60	60"	120, 208 or 240	1050	15 lbs.	704
GR-72	72"	120, 208 or 240	1275	19 lbs.	838
GR-96 [*]	96"	120, 208 or 240	1725	24 lbs.	1015
High Watt					
GRH-18	18"	120, 208 or 240	350	8 lbs.	\$ 489
GRH-24	24"	120, 208 or 240	500	7 lbs.	514
GRH-36	36"	120, 208 or 240	800	10 lbs.	580
GRH-48	48"	120, 208 or 240	1100	13 lbs.	630
GRH-60	60"	120, 208 or 240	1400	16 lbs.	712
GRH-72 [*]	72"	120, 208 or 240	1725	19 lbs.	846
GRH-96	96"	208 or 240	2400	24 lbs.	1023

^o Does not include Remote Control Enclosure (RMB), see pages 96 and 97.

^{*} Infinite Switch not available in 120V.

All Stainless Steel Models Feature:

Toggle Switch (max. 15 Amps) Location: Chef's left side.

Leads: 3' conduit with leads – server's right. NEMA 5-15P cord available on 120 volt models 72" or less with C-leg, T-leg stand or chain-hook mount.

GRH-72 requires NEMA 5-20P cord for Canada.

Dimensions: 18"-96"W x 6"D x 2 1/4"H.

Contact factory for stainless marine applications.

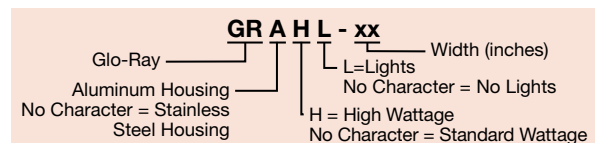



GRAHL-48
with optional
Sneeze Guard

OPTIONS (available at time of purchase only - not available as Quick-Ship)

Designer Colors, aluminum models 18"-144" – Non-standard colors are non-returnable – Clear Anodized standard –

COLOR-6	6" Housing for GRA and GRAH models (color selection below)				per foot	\$32
COLOR-9	9" Housing for GRAL and GRAHL models (color selection below)				per foot	32
	RED	Warm Red	GRAY	Gray Granite	NAVY	Navy Blue
	BLACK	Black	WHITE	White Granite	GREEN	Hunter Green
					COPPER	Antique Copper

Gloss Finishes, aluminum models 18"-144" – Non-standard colors are non-returnable – Clear Anodized standard –

GLOSS-6	6" Housing for GRA and GRAH models (finish selection below)				per foot	\$44
GLOSS-9	9" Housing for GRAL and GRAHL models (finish selection below)				per foot	44
	RRED	Radiant Red	GGRAY	Glossy Gray	BBLACK	Bold Black
	GGOLD	Gleaming Gold	BBLUE	Brilliant Blue		

IND. LGT	Indicator Light (Remote Control only on all Tandem Element units)		\$20
-----------------	---	--	------

Power Leads – Extended beyond standard 3' Conduit (must specify lead length) –

LEADS5	1'-5' extended Electrical Leads	\$ 27
LEADS10	6'-10' extended Electrical Leads	54
LEADS15	11'-15' extended Electrical Leads	81
LEADS20	16'-20' extended Electrical Leads	108

Sneeze Guards

9.375BP1	9¾" Sneeze Guard (aluminum models only) one side	per foot	\$ 71
9.375BP2	9¾" Sneeze Guard (aluminum models only) two sides	per foot	142
14BP1	14" Sneeze Guard (aluminum models only) one side	per foot	113
14BP2	14" Sneeze Guard (aluminum models only) two sides	per foot	226
HAL	60 Watt Halogen Bulb in lieu of standard Display Light (aluminum models only)	each	63
NO BULB	No bulb option (GRAL, GRAHL models only)		No Charge
LIGHTS-ADD'L	Extra Lamps – Installed (max. two per foot less one per foot is standard) must be ordered with remote switches only, aluminum models only	each	32
3 ANEAL REFL	Bright Annealed Reflector for Lights (aluminum models only)	per foot	27
NO CONTROL	No control included (GRA, GRAH, GRAL, GRAHL, GR, GRH models only) Requires selection of RMB2-xx control - see page 96		No Charge
BLT INF	Infinite Control Built-In in lieu of Toggle (max. 12.2 Amps) (remote installation recommended)	each	47
REM INF	Remote Infinite Switches in lieu of Toggle (max. 12.2 Amps)	each	47
REM TOG	Remote Toggle Switches (max. 15 Amps)		No Charge
RMB	Remote Control Enclosure (available in Designer Colors or Gloss Finishes) – Non-standard colors are non-returnable –		see pages 96 and 97

Stands

ATL	Adjustable Tubular Stands 10"-14" (not available in Designer Colors) – Not available with cord	1 pair	\$245
NTL-10, -12	Non-Adjustable Tubular Stands (specify 10" or 12" clearance) – Not available with cord	1 pair	113
NTL-14, -16	Non-Adjustable Tubular Stands (specify 14" or 16" clearance) – Not available with cord	1 pair	121
NTL-PAINT	Designer Color or Gloss Finish to match unit color for Non-Adjustable Tubular Stands – Non-standard colors are non-returnable –	1 pair	45
CL-LOW	C-Leg Stands, standard Watt – 10" clearance (for models up to 72" wide) – Only available with cord	1 pair	129
CL-HIGH	C-Leg Stands, High Watt – 13½" clearance (for models up to 72" wide) – Only available with cord	1 pair	145
TL-10	T-Leg Stands, standard Watt – 10" clearance (for models only up to 72" wide) – Only available with cord	1 pair	312
TL-13	T-Leg Stands, 13½" clearance (for models up to 72" wide) – Only available with cord	1 pair	344
TL-16	T-Leg Stands, 16" clearance (for models up to 72" wide) – Only available with cord	1 pair	366
TL-18	T-Leg Stands, 18" clearance (for models up to 72" wide) – Only available with cord	1 pair	393
CAP	Attached 6' Cord and Plug Set (120V only) on models up to 72" wide, requires standard Chain Mount Kit (two S Hooks with two 6" lengths of chain) or add optional C-leg Stands or T-leg Stands (see specific model for plug configuration)		37
CHAIN-HOOK	Two S Hooks with two 6" lengths of chain	each	14

ACCESSORIES (available for purchase at any time)

ADJ ANGLE	Adjustable Angle Brackets (GRA, GRAH models only) (see page 95 for illustration)	1 pair	\$ 29
ADJ ANGLE7	7" tall Adjustable Angle Brackets (see page 95 for illustration)	1 pair	34
GR-ANGLE	Adjustable Angle Brackets (GR models only) (see page 95 for illustration)	1 pair	29
CHAIN 1	Chain Suspension (see page 95 for illustration)	per foot	14
Chef LED Bulb 120V adjustable bulb – GRAL, GRAHL models only, all voltages – see page 63 for more information –		each	129
	GRAHL requires pass-through usage only and unit must be 10" or higher from surface – bulbs must be rotated down –		
	CLED-2700-120 Similar to warm Incandescent	CLED-3000-120 Similar to warm Halogen light	CLED-4000-120 Similar to cool Fluorescent light

COLORS AND FINISHES – INSIDE BACK COVER

Glo-Ray® Aluminium Dual Infrared Strip Heaters

Create a deeper holding area with Glo-Ray Aluminum Dual Infrared Strip Heaters mounted side-by-side, keeping hot food at optimum serving temperatures. The pre-focused heat pattern directs heat from a metal-sheathed element across the entire holding surface. The continuous aluminum housing and heavy-duty mountings ensure the durability and quality of Hatco products.

- Ensures maximum flavor, safety and holding time
- Provides even heat distribution, no "cold spots"
- Sturdy extruded aluminum housings that do not sag, from 18" to 144" (12')
- Reflector does not blacken, maintaining a consistent heat pattern
- Protective wire guard supports heating element without affecting heat distribution
- 3" or 6" spacer available
- Heavy-duty insulation minimizes heat loss
- Additional reflector styles and lower wattage elements available, consult factory for more information



GRAH-72D with optional Designer Warm Red, 6" spacer and tandem elements

GRA-36D with standard 3" spacer

Toggle Switch: Max. 15 Amps
Infinite Switch: Max. 12.2 Amps

NOTE: 120V models may require additional switches.

Quick-Ship Model pages 241-247

GLO-RAY ALUMINUM DUAL INFRARED STRIP HEATERS

Model	Width	Voltage		Watts	Ship Weight	List Price ^o	
		Single Phase				3" Spacer	6" Spacer
Standard Watt							
GRA-18D	18"	120, 208 or 240		500	14 lbs.	\$ 806	\$ 820
GRA-24D	24"	120, 208 or 240		700	16 lbs.	841	855
GRA-30D	30"	120, 208 or 240		900	18 lbs.	931	950
GRA-36D	36"	120, 208 or 240		1150	19 lbs.	1020	1039
GRA-42D	42"	120, 208 or 240		1350	23 lbs.	1110	1129
GRA-48D	48"	120, 208 or 240		1600	27 lbs.	1199	1225
GRA-54D	54"	120, 208 or 240		1850	30 lbs.	1288	1314
GRA-60D	60"	120, 208 or 240		2100	35 lbs.	1388	1428
GRA-66D	66"	120, 208 or 240		2320	36 lbs.	1526	1566
GRA-72D	72"	120, 208 or 240		2550	36 lbs.	1709	1749
GRA-84D ^v	84"	120, 208 or 240		3000	50 lbs.	1978	2032
GRA-96D ^v	96"	120, 208 or 240		3450	52 lbs.	2255	2309
GRA-108D	108"	120, 208 or 240		3700	59 lbs.	2713	2767
GRA-120D	120"	120, 208 or 240		4200	66 lbs.	2962	3044
GRA-132D ^h	132"	120, 208 or 240		4640	73 lbs.	3214	3296
GRA-144D	144"	120, 208 or 240		5100	80 lbs.	3472	3554
High Watt							
GRAH-18D	18"	120, 208 or 240		700	14 lbs.	\$ 822	\$ 836
✓ GRAH-24D	24"	120, 208 or 240		1000	16 lbs.	857	871
✓ GRAH-30D	30"	120, 208 or 240		1320	18 lbs.	947	966
✓ GRAH-36D	36"	120, 208 or 240		1600	19 lbs.	1036	1055
✓ GRAH-42D	42"	120, 208 or 240		1900	24 lbs.	1126	1145
✓ GRAH-48D	48"	120, 208 or 240		2200	27 lbs.	1215	1241
GRAH-54D	54"	120, 208 or 240		2500	30 lbs.	1304	1330
GRAH-60D	60"	120, 208 or 240		2800	34 lbs.	1404	1444
GRAH-66D ^v	66"	120, 208 or 240		3120	38 lbs.	1542	1582
GRAH-72D ^v	72"	120, 208 or 240		3450	36 lbs.	1725	1765
GRAH-84D ^h	84"	120, 208 or 240		4100	50 lbs.	1994	2048
GRAH-96D ^h	96"	120, 208 or 240		4800	52 lbs.	2271	2325
GRAH-108D	108"	120, 208 or 240		5000	59 lbs.	2729	2783
GRAH-120D ^h	120"	120, 208 or 240		5600	66 lbs.	2978	3060
GRAH-132D	132"	208 or 240		6240	73 lbs.	3230	3312
GRAH-144D	144"	208 or 240		6900	80 lbs.	3488	3570

^o Does not include Remote Control Enclosure (RMB), see pages 96 and 97.

^v When using an infinite control with 120 volt model, additional switch(es) and tandem (end-to-end) elements are required.

^h Available with RMB or remote switch only. Consult factory for additional charges.

^h 120 volt models require additional switches and tandem (end-to-end) elements.

All Glo-Ray Aluminum Dual Infrared Models Feature:

Toggle Switch (max. 15 Amps) Location: Chef's left side (unless otherwise specified).

Leads: 3' conduit with leads – server's right.

Dimensions: with 3" Spacer (standard): 18"-144"W x 15"D x 2½"H.

with 6" Spacer: 18"-144"W x 18"D x 2½"H.

OPTIONS AND ACCESSORIES – PAGE 75

RECOMMENDED MOUNTING HEIGHTS – PAGE 94

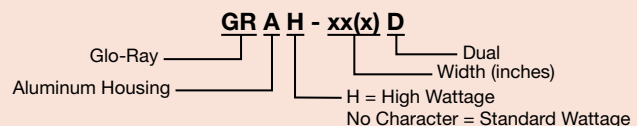

Glo-Ray® Aluminium Dual Infrared Strip Heaters *continued*

- A** Shown with optional lights (shatter-resistant incandescent lights or halogen bulbs available)
- B** Sturdy extruded aluminum housings that do not sag, from 18" up to 144" (12')
- C** Reflector does not blacken, maintaining a consistent heat pattern
- D** Standard Hanger Tab is provided for under shelf or chain installation
- E** Heavy-duty insulation minimizes heat loss
- F** Metal-sheathed heating element part guaranteed against burnout and breakage for two years
- G** Protective wire guard supports heating element without affecting heat distribution

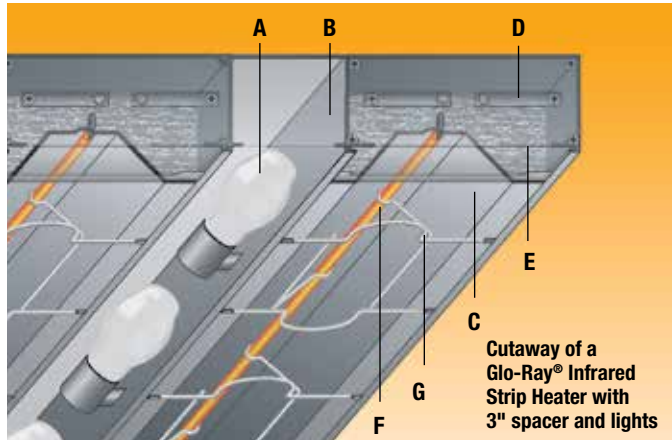

Cutaway of a Glo-Ray® Infrared Strip Heater with 3" spacer and lights

Toggle Switch: Max. 15 Amps
Infinite Switch: Max. 12.2 Amps

Quick-Ship Model pages 241-247

GLO-RAY ALUMINUM DUAL INFRARED STRIP HEATERS WITH LIGHTS

Strip Heaters

Model	Bulbs	Width	Voltage		Watts	Ship Weight	List Price ^o	
			Single Phase				3" Spacer	6" Spacer
Standard Watt								
GRAL-18D	2	18"	120, 120/208 or 120/240		620	14 lbs.	\$ 895	\$ 909
GRAL-24D	2	24"	120, 120/208 or 120/240		820	16 lbs.	925	939
GRAL-30D	2	30"	120, 120/208 or 120/240		1020	19 lbs.	1033	1052
GRAL-36D	3	36"	120, 120/208 or 120/240		1330	22 lbs.	1143	1162
GRAL-42D	3	42"	120, 120/208 or 120/240		1530	25 lbs.	1256	1275
GRAL-48D	4	48"	120, 120/208 or 120/240		1840	30 lbs.	1370	1396
GRAL-54D	4	54"	120, 120/208 or 120/240		2090	34 lbs.	1491	1517
GRAL-60D	5	60"	120, 120/208 or 120/240		2400	35 lbs.	1622	1662
GRAL-66D	5	66"	120, 120/208 or 120/240		2620	39 lbs.	1777	1817
GRAL-72D	6	72"	120, 120/208 or 120/240		2910	42 lbs.	1988	2028
GRAL-84D [▼]	7	84"	120, 120/208 or 120/240		3420	50 lbs.	2301	2355
GRAL-96D [▼]	8	96"	120, 120/208 or 120/240		3930	56 lbs.	2616	2670
GRAL-108D	9	108"	120, 120/208 or 120/240		4240	64 lbs.	3109	3163
GRAL-120D [▶]	10	120"	120, 120/208 or 120/240		4800	72 lbs.	3403	3485
GRAL-132D [▶]	11	132"	120, 120/208 or 120/240		5300	79 lbs.	3702	3784
GRAL-144D [▶]	12	144"	120, 120/208 or 120/240		5820	86 lbs.	4004	4086
High Watt								
GRAHL-18D	2	18"	120, 120/208 or 120/240		820	14 lbs.	\$ 911	\$ 925
✓ GRAHL-24D	2	24"	120, 120/208 or 120/240		1120	16 lbs.	941	955
GRAHL-30D	2	30"	120, 120/208 or 120/240		1440	19 lbs.	1049	1068
✓ GRAHL-36D	3	36"	120, 120/208 or 120/240		1780	22 lbs.	1159	1178
GRAHL-42D	3	42"	120, 120/208 or 120/240		2080	25 lbs.	1272	1291
✓ GRAHL-48D	4	48"	120, 120/208 or 120/240		2440	30 lbs.	1386	1412
GRAHL-54D	4	54"	120, 120/208 or 120/240		2740	33 lbs.	1507	1533
GRAHL-60D	5	60"	120, 120/208 or 120/240		3100	37 lbs.	1638	1678
GRAHL-66D [▼]	5	66"	120, 120/208 or 120/240		3420	38 lbs.	1793	1833
GRAHL-72D [▼]	6	72"	120, 120/208 or 120/240		3810	42 lbs.	2004	2044
GRAHL-84D [▲]	7	84"	120, 120/208 or 120/240		4520	50 lbs.	2317	2371
GRAHL-96D [▲]	8	96"	120, 120/208 or 120/240		5280	54 lbs.	2632	2686
GRAHL-108D [▶]	9	108"	120, 120/208 or 120/240		5540	64 lbs.	3125	3179
GRAHL-120D [▶]	10	120"	120, 120/208 or 120/240		6200	72 lbs.	3419	3501
GRAHL-132D [▶]	11	132"	120, 120/208 or 120/240		6900	79 lbs.	3718	3800
GRAHL-144D [▶]	12	144"	120/208 or 120/240		7620	86 lbs.	4020	4102

^o Does not include Remote Control Enclosure (RMB), see pages 96 and 97.

[▼] When using an infinite control with 120 volt model, additional switch(es) and tandem (end-to-end) elements required.

[▶] Available with RMB or remote switch only. Consult factory for additional charges.

[▲] 120 volt models require additional switches (available with remote switches only) and tandem (end-to-end) elements.

All Glo-Ray Aluminum Dual Models with Lights Feature:

Toggle Switch (max. 15 Amps) Location: Chef's left side (unless otherwise specified).

Leads: 3' conduit with leads – server's right.

Dimensions: with 3" Spacer (standard): 15"D x 2½"H.

with 6" Spacer: 18"D x 2½"H.

OPTIONS AND ACCESSORIES – PAGE 75

RECOMMENDED MOUNTING HEIGHTS – PAGE 94

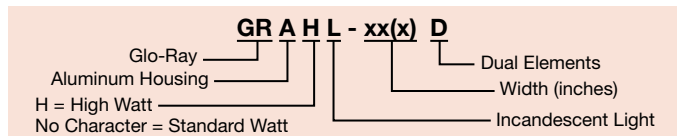



A series of **GRAH-60D** models

Strip Heaters

OPTIONS (available at time of purchase only - not available on Quick-Ship)

Designer Colors, aluminum models 18"-144" – Non-standard colors are non-returnable – Clear Anodized standard –

COLOR-15, -18	15" and 18" Housings for GRA, GRAH, GRAL and GRAHL Dual models (Clear Anodized standard)						per foot	\$46
	RED	Warm Red	GRAY	Gray Granite	NAVY	Navy Blue	COPPER	Antique Copper
	BLACK	Black	WHITE	White Granite	GREEN	Hunter Green		

Gloss Finishes, aluminum models 18"-144" – Non-standard colors are non-returnable – Clear Anodized standard –

GLOSS-15, -18	15" and 18" Housings for GRA, GRAH, GRAL and GRAHL Dual models (Clear Anodized standard)						per foot	\$59
	RRED	Radiant Red	GGRAY	Glossy Gray	BBLACK	Bold Black		
	GGOLD	Gleaming Gold	BBLUE	Brilliant Blue				

IND. LGT	Indicator Light (remote only)							\$20
-----------------	-------------------------------	--	--	--	--	--	--	-------------

Power Leads – Extended beyond standard 3' Conduit (must specify lead length) –

LEADS5	1'-5' extended Electrical Leads							\$ 27
LEADS10	6'-10' extended Electrical Leads							54
LEADS15	11'-15' extended Electrical Leads							81
LEADS20	16'-20' extended Electrical Leads							108

9.375BP1	9 3/8" Sneeze Guard, one side							per foot \$ 71
9.375BP2	9 3/8" Sneeze Guard, two sides							per foot 142
14BP1	14" Sneeze Guard, one side							per foot 113
14BP2	14" Sneeze Guard, two sides							per foot 226

HAL	60 Watt Halogen Bulb in lieu of standard Display Light							each 63
------------	--	--	--	--	--	--	--	----------------

NO BULB	No bulb option (GRAL-xxD, GRAHL-xxD models only)							No Charge
----------------	--	--	--	--	--	--	--	------------------

LIGHTS-ADD'L	Extra Lamps – Installed (maximum two per foot less one – one per foot is standard)							each 32
---------------------	--	--	--	--	--	--	--	----------------

3 ANEAL REFL	Bright Annealed Reflector for lights with 3" Spacer							per foot 27
---------------------	---	--	--	--	--	--	--	--------------------

6 ANEAL REFL	Bright Annealed Reflector for lights with 6" Spacer							per foot 40
---------------------	---	--	--	--	--	--	--	--------------------

NO CONTROL	No control included (GRA, GRAH, GRAL, GRAHL-xxD models only) Requires selection of RMB2-xx control (see page 96)							No Charge
-------------------	--	--	--	--	--	--	--	------------------

REM INF	Remote Infinite Switches (max. 12.2 Amps)							each 47
----------------	---	--	--	--	--	--	--	----------------

REM TOG	Remote Toggle Switches (max. 15 Amps)							No Charge
----------------	---------------------------------------	--	--	--	--	--	--	------------------

RMB	Remote Control Enclosure (available in Designer Colors or Gloss Finishes) – Non-standard colors are non-returnable – Clear Anodized standard –							see page 96 and 97
------------	--	--	--	--	--	--	--	--------------------

ATL-D	Adjustable Tubular Stands 10"-14" (not available in Designer Colors)							2 pair \$489
--------------	--	--	--	--	--	--	--	---------------------

NTL-10-D, -12-D	Non-Adjustable Tubular Stands (specify 10" or 12" clearance)							2 pair 227
------------------------	--	--	--	--	--	--	--	-------------------

NTL-14-D, -16-D	Non-Adjustable Tubular Stands (specify 14" or 16" clearance)							2 pair 242
------------------------	--	--	--	--	--	--	--	-------------------

NTL-PAINT-D	Designer Color or Gloss Finish for Non-Adjustable Tubular Stands to match unit color – Non-standard colors are non-returnable –							2 pair 90
--------------------	---	--	--	--	--	--	--	------------------

ACCESSORIES (available for purchase at any time)

ADJ ANGLE-D	Adjustable Angle Brackets for Dual models (see page 95 for illustration)							2 pair \$ 58
--------------------	--	--	--	--	--	--	--	---------------------

ADJ ANGLE7-D	7" tall Adjustable Angle Brackets for Dual models (see page 95 for illustration)							2 pair 68
---------------------	--	--	--	--	--	--	--	------------------

CHAIN 1	Chain Suspension (see page 95 for illustration)							per foot 14
----------------	---	--	--	--	--	--	--	--------------------

Chef LED 120V adjustable bulb – GRAL-xxD, GRAHL-xxD models only, all voltages – pass-through usage only –								each 129
--	--	--	--	--	--	--	--	-----------------

See page 63 for more information –

GRAL-xxD must be 15" or higher from surface, GRAHL-xxD must be 18" or higher from surface as pass through –

Bulbs must be rotated down –

CLED-2700-120 Similar to warm Incandescent **CLED-3000-120** Similar to warm Halogen light **CLED-4000-120** Similar to cool Fluorescent light

COLORS AND FINISHES – INSIDE BACK COVER



Glo-Ray® Aluminium Max Watt Infrared Strip Heaters

Safely hold the temperature of your product without drying out or further cooking food with Hatco's Glo-Ray Aluminium Max Watt Infrared Strip Heaters. The end result is hot, fresh food that's ready-to-serve. The continuous aluminum housing and heavy-duty mountings ensure the durability and quality of Hatco products.

- Features 25% greater wattage output than Glo-Ray high watt by comparison with single units varying in watts from 450 to 4150 watts; and units with lights varying from 570 to 4870 watts
- Sturdy extruded aluminum housings that do not sag, from 18" to 72" in 6" increments and 84" to 144" in 12" increments
- Protective wire guards under heating element
- Available options include Built-in Toggle Control, Toggle Control Remote Box, Electronic Infinite Control Remote Box or loose Remote Controls.
- Shatter-resistant incandescent lights (standard on GRAML models) enhance product display while safeguarding food products from bulb breakage. An optional halogen bulb may be used in lieu of incandescents
- Additional reflector styles available, consult factory for more information
- Heavy-duty insulation minimizes heat loss



GRAM-36



GRAML-36 with shatter-resistant incandescent lights and standard angle brackets

GLO-RAY ALUMINUM MAX WATT INFRARED STRIP HEATERS

Model	Width	Voltage Single Phase	Watts	Ship Weight [◇]	List Price [*]
Max Watt					
GRAM-18	18"	120, 208 or 240	450	9 lbs.	\$ 504
GRAM-24	24"	120, 208 or 240	650	10 lbs.	520
GRAM-30	30"	120, 208 or 240	825	10 lbs.	546
GRAM-36	36"	120, 208 or 240	1000	12 lbs.	560
GRAM-42	42"	120, 208 or 240	1175	12 lbs.	585
GRAM-48	48"	120, 208 or 240	1300	15 lbs.	611
GRAM-54	54"	120, 208 or 240	1500	16 lbs.	639
GRAM-60	60"	120, 208 or 240	1700	17 lbs.	668
GRAM-66 [▲]	66"	120, 208 or 240	1875	21 lbs.	732
GRAM-72 [▲]	72"	120, 208 or 240	2075	21 lbs.	799
GRAM-84 [▲]	84"	120, 208 or 240	2400	22 lbs.	886
GRAM-96 [▼]	96"	120, 208 or 240	2675	25 lbs.	977
GRAM-108 ^{▶*}	108"	208 or 240	3000	23 lbs.	1143
GRAM-120 ^{▶*}	120"	208 or 240	3400	26 lbs.	1224
GRAM-132 ^{▶*}	132"	208 or 240	3750	30 lbs.	1301
GRAM-144 ^{▶*}	144"	208 or 240	4150	33 lbs.	1385

- ◇ Add 2-8 lbs. depending on Remote Control Enclosure (RMB).
- * Includes either Remote Control Enclosure (RMB) with toggle switch(es) and indicator light(s) or Attached Control Enclosure with toggle switch(es) except as noted (please specify).
- ▲ 120V models require additional switches and tandem (end-to-end) elements or the use of Electronic infinite control (RMB).
- ▼ 120 volt models require additional switches and tandem (end-to-end) elements.
- ▶ Models contain tandem (end-to-end) elements that may be individually controlled.
- * All voltages not available with Built-in Controls.

All Glo-Ray Aluminium Max Watt Infrared Models Feature:

Includes: Angle Brackets and Attached or Remote Control Enclosure (RMB).
Leads: 3' conduit with leads – server's right.
Dimensions: 18"-144"W x 6"D x 2½"H.

GLO-RAY ALUMINUM MAX WATT INFRARED STRIP HEATERS with LIGHTS

Model	Bulbs	Width	Voltage Single Phase	Watts	Ship Weight [◇]	List Price [*]
Max Watt						
GRAML-18	2	18"	120, 120/208 or 120/240	570	10 lbs.	\$ 701
GRAML-24	2	24"	120, 120/208 or 120/240	770	13 lbs.	716
GRAML-30	2	30"	120, 120/208 or 120/240	945	15 lbs.	784
GRAML-36	3	36"	120, 120/208 or 120/240	1180	15 lbs.	834
GRAML-42	3	42"	120, 120/208 or 120/240	1355	19 lbs.	885
GRAML-48	4	48"	120, 120/208 or 120/240	1540	20 lbs.	949
GRAML-54	4	54"	120, 120/208 or 120/240	1740	24 lbs.	1019
GRAML-60 [□]	5	60"	120, 120/208 or 120/240	2000	22 lbs.	1091
GRAML-66 ^{□▲}	5	66"	120, 120/208 or 120/240	2175	25 lbs.	1230
GRAML-72 ^{□▲}	6	72"	120, 120/208 or 120/240	2435	29 lbs.	1335
GRAML-84 ^{□▲}	7	84"	120, 120/208 or 120/240	2820	32 lbs.	1500
GRAML-96 ^{▼*}	8	96"	120, 120/208 or 120/240	3155	37 lbs.	1664
GRAML-108 ^{▶*}	9	108"	120/208 or 120/240	3540	36 lbs.	1939
GRAML-120 ^{▶*}	10	120"	120/208 or 120/240	4000	40 lbs.	2098
GRAML-132 ^{▶*}	11	132"	120/208 or 120/240	4410	44 lbs.	2264
GRAML-144 ^{▶*}	12	144"	120/208 or 120/240	4870	48 lbs.	2433

- ◇ Add 2-8 lbs. depending on Remote Control Enclosure (RMB).
- * Includes Remote Control Enclosure (RMB) with toggle switch(es) and indicator light(s) or Attached Control Enclosure with toggle switch(es) except as noted (please specify).
- 120 volt models not available with Built-in Controls.
- ▲ 120V models require additional switches and tandem (end-to-end) elements or the use of Electronic infinite control (RMB).
- ▼ 120 volt models require additional switches and tandem (end-to-end) elements.
- ▶ Models contain tandem (end-to-end) elements that may be individually controlled.
- * All voltages not available with Built-in Controls.

All Glo-Ray Aluminium Max Watt Infrared with Lights Models Feature:

Includes: Angle Brackets and Attached or Remote Control Enclosure (RMB).
Leads: 3' conduit with leads – server's right.
Dimensions: 18"-144"W x 9"D x 2½"H.

OPTIONS AND ACCESSORIES – PAGE 77
RECOMMENDED MOUNTING HEIGHTS – PAGE 94

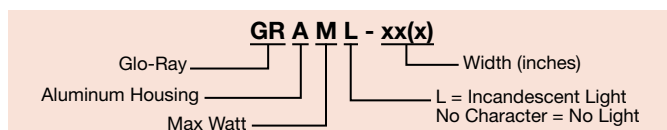



GRAML-48
with standard
angle brackets

OPTIONS (available at time of purchase only)

Designer Colors, aluminum models 18"-144" – Non-standard colors are non-returnable – Clear Anodized standard –

COLOR-6	6" Housing for GRAM models						per foot	\$32
	RED Warm Red	GRAY Gray Granite	NAVY Navy Blue	COPPER Antique Copper				
	BLACK Black	WHITE White Granite	GREEN Hunter Green					
COLOR-9	9" Housing for GRAML models						per foot	32
	RED Warm Red	GRAY Gray Granite	NAVY Navy Blue	COPPER Antique Copper				
	BLACK Black	WHITE White Granite	GREEN Hunter Green					
RMB-COLOR	Remote Control Enclosure Housing in Designer Colors (select color below)							46
	RED Warm Red	GRAY Gray Granite	NAVY Navy Blue	COPPER Antique Copper				
	BLACK Black	WHITE White Granite	GREEN Hunter Green					

Gloss Finishes, aluminum models 18"-144" – Non-standard colors are non-returnable – Clear Anodized standard –

GLOSS-6	6" Housing for GRAM models						per foot	\$44
	RRED Radiant Red	GGRAY Glossy Gray	BBLACK Bold Black					
	GGOLD Gleaming Gold	BBLUE Brilliant Blue						
GLOSS-9	9" Housing for GRAML models						per foot	44
	RRED Radiant Red	GGRAY Glossy Gray	BBLACK Bold Black					
	GGOLD Gleaming Gold	BBLUE Brilliant Blue						
RMB-GLOSS	Remote Control Enclosure Housing in Gloss Finishes – Non-standard colors are non-returnable – Clear Anodized standard –							66
	RRED Radiant Red	GGRAY Glossy Gray	BBLACK Bold Black					
	GGOLD Gleaming Gold	BBLUE Brilliant Blue						

Power Leads – Extended beyond standard 3' Conduit (must specify lead length) –

HTLEADS5	1'-5' extended Electrical Leads	\$ 38
HTLEADS10	6'-10' extended Electrical Leads	76
HTLEADS15	11'-15' extended Electrical Leads	114
HTLEADS20	16'-20' extended Electrical Leads	152

3 ANEAL REFL Bright Annealed Reflector for lights with 3" Spacer **per foot \$ 27**

RMB-GRAM-INF Remote Control Enclosure with Toggle Control Switch, Electronic Infinite Control, Relay and Indicator Light (in lieu of standard Remote Control Enclosure) **448**

BLT TOG Built in Control - not available for GRAM(L) 66-96 in 120V **No Charge**

NTL-14, -16 Non-Adjustable Tubular Stands – specify 14" or 16" clearance **pair 121**

NTL-18, -20 Non-Adjustable Tubular Stands – specify 18" or 20" clearance **pair 129**

NTL-22, -24 Non-Adjustable Tubular Stands – specify 22" or 24" clearance **pair 140**

NTL-PAINT Designer Color or Gloss Finish for Non-Adjustable Tubular Stands (one pair) – Non-standard colors are non-returnable – **pair 45**

	RED Warm Red	GRAY Gray Granite	NAVY Navy Blue	COPPER Antique Copper			
	BLACK Black	WHITE White Granite	GREEN Hunter Green				
	RRED Radiant Red	GGRAY Glossy Gray	BBLACK Bold Black				
	GGOLD Gleaming Gold	BBLUE Brilliant Blue					

CAP Attached 6' Cord and Plug Set (120V only) on models up to 48" requires standard Chain Mount Kit: Two S Hooks with two 6" lengths of chain (available for GRAM models only) **37**

CHAIN-HOOK Two S Hooks with two 6" lengths of chain **each 14**

HAL 60 Watt Halogen Bulb in lieu of standard Display Light **each 63**

NO BULB No bulb option (GRAML models only) **No Charge**

ACCESSORIES (available for purchase at any time)

CHAIN 1 Chain Suspension **per foot \$ 14**

Chef LED 120V adjustable bulb – GRAML-xx models only, all voltages – pass-through usage only – see page 63 for more information – **each 129**
GRAML-xx must be 13" or higher from surface as pass through – bulbs must be rotated down –

CLED-2700-120 Similar to warm Incandescent **CLED-3000-120** Similar to warm Halogen light **CLED-4000-120** Similar to cool Fluorescent light

COLORS AND FINISHES – INSIDE BACK COVER

Strip Heaters



Glo-Ray® Aluminum Max Watt Dual Infrared Strip Heaters

Create a deeper holding area with Glo-Ray Aluminium Max Watt Dual Aluminum Infrared Strip Heaters mounted side-by-side, keeping hot food at optimum serving temperatures. The pre-focused heat pattern directs heat from a metal-sheathed element, bathing the entire holding surface. The continuous aluminum housing and heavy-duty mountings ensure the durability and quality of Hatco products.

- Features 25% greater wattage output than Glo-Ray high watt by comparison with dual units varying in wattage from 900 to 8300 watts; and units with lights varying from 1020 to 9020 watts
- Sturdy extruded aluminum housings that do not sag, from 18" to 72" in 6" increments and 84" to 144" in 12" increments
- Protective wire guard supports heating element without affecting heat distribution
- 3" or 6" spacer available
- Heavy-duty insulation minimizes heat loss
- Shatter-resistant incandescent lights (standard on GRAML models) enhance product display while safeguarding food products from bulb breakage. An optional halogen bulb may be used in lieu of incandescents
- Additional reflector styles available, consult factory for more information



GRAM-36D
with standard 3" spacer

GLO-RAY ALUMINUM MAX WATT DUAL INFRARED STRIP HEATERS

Model	Width	Voltage		Watts	Ship Weight [◇]	List Price*	
		Single Phase				3" Spacer	6" Spacer
Max Watt							
GRAM-18D	18"	120, 208 or 240		900	13 lbs.	\$ 972	\$ 986
GRAM-24D	24"	120, 208 or 240		1300	18 lbs.	1008	1022
GRAM-30D	30"	120, 208 or 240		1650	20 lbs.	1088	1107
GRAM-36D	36"	120, 208 or 240		2000	23 lbs.	1166	1185
GRAM-42D	42"	120, 208 or 240		2350	27 lbs.	1246	1265
GRAM-48D	48"	120, 208 or 240		2600	34 lbs.	1329	1355
GRAM-54D	54"	120, 208 or 240		3000	32 lbs.	1418	1444
GRAM-60D	60"	120, 208 or 240		3400	35 lbs.	1513	1553
GRAM-66D ^{>}	66"	120, 208 or 240		3750	37 lbs.	1718	1758
GRAM-72D ^{>}	72"	120, 208 or 240		4150	43 lbs.	1908	1948
GRAM-84D ^{>}	84"	120, 208 or 240		4800	44 lbs.	2146	2200
GRAM-96D ^{>▼}	96"	120, 208 or 240		5350	54 lbs.	2386	2440
GRAM-108D	108"	208 or 240		6000	59 lbs.	2803	2857
GRAM-120D	120"	208 or 240		6800	66 lbs.	3041	3123
GRAM-132D	132"	208 or 240		7500	73 lbs.	3274	3356
GRAM-144D	144"	208 or 240		8300	80 lbs.	3509	3591

◇ Add 2-8 lbs. depending on Remote Control Enclosure (RMB).

* Includes Remote Control Enclosure (RMB) with toggle switch(es) and indicator light(s)

> 120 volt models require RMB-GRAM-INF only, see page 80 for additional cost.

▼ When using an Infinite Control with 120 volt model, additional switch(es) and tandem (end-to-end) elements are required.

All Glo-Ray Aluminum Max Watt Dual Infrared Models Feature:

Includes: Angle Brackets and Remote Control Enclosure (RMB).

Leads: 3' conduit with leads – server's right.

Dimensions: with 3" Spacer (standard): 18"-144"W x 15"D x 2½"H.

with 6" Spacer: 18"-144"W x 18"D x 2½"H.

OPTIONS AND ACCESSORIES – PAGE 80

RECOMMENDED MOUNTING HEIGHTS – PAGE 94

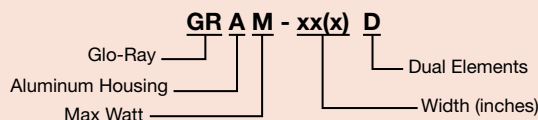

Strip Heaters

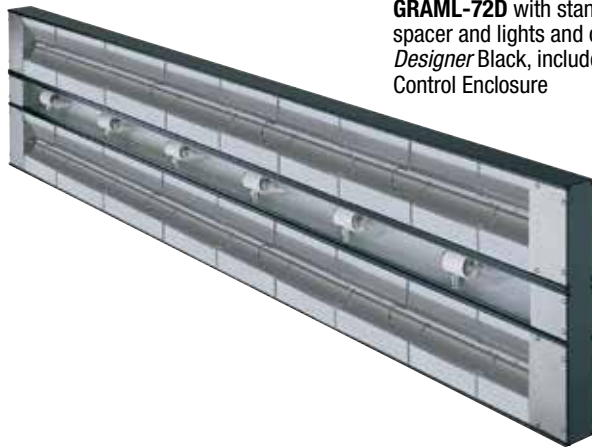

GRAML-72D with standard 3" spacer and lights and optional Black Designer Black, includes Remote Control Enclosure

GLO-RAY ALUMINUM MAX WATT DUAL INFRARED STRIP HEATERS with LIGHTS

Model	Bulbs	Width	Voltage		Watts	Ship Weight [◇]	List Price ⁺	
			Single Phase				3" Spacer	6" Spacer
Max Watt								
GRAML-18D	2	18"	120, 120/208 or 120/240		1020	15 lbs.	\$1107	\$1121
GRAML-24D	2	24"	120, 120/208 or 120/240		1420	19 lbs.	1139	1153
GRAML-30D	2	30"	120, 120/208 or 120/240		1770	20 lbs.	1244	1263
GRAML-36D	3	36"	120, 120/208 or 120/240		2180	22 lbs.	1335	1354
GRAML-42D	3	42"	120, 120/208 or 120/240		2530	29 lbs.	1441	1460
GRAML-48D	4	48"	120, 120/208 or 120/240		2840	33 lbs.	1540	1566
GRAML-54D	4	54"	120/208 or 120/240		3240	34 lbs.	1656	1682
GRAML-60D	5	60"	120/208 or 120/240		3700	38 lbs.	1771	1811
GRAML-66D [▲]	5	66"	120/208 or 120/240		4050	43 lbs.	1996	2036
GRAML-72D [▲]	6	72"	120/208 or 120/240		4510	45 lbs.	2206	2246
GRAML-84D [▲]	7	84"	120/208 or 120/240		5220	49 lbs.	2475	2529
GRAML-96D [▶]	8	96"	120/208 or 120/240		5830	60 lbs.	3210	3264
GRAML-108D [▶]	9	108"	120/208 or 120/240		6540	64 lbs.	3166	3220
GRAML-120D [▶]	10	120"	120/208 or 120/240		7400	72 lbs.	3452	3534
GRAML-132D [▶]	11	132"	120/208 or 120/240		8160	79 lbs.	3742	3824
GRAML-144D [▶]	12	144"	120/208 or 120/240		9020	86 lbs.	4033	4115

- † Includes Remote Control Enclosure (RMB) with toggle switch(es) and indicator light(s).
 - ◇ Add 2-8 lbs. depending on Remote Control Enclosure (RMB).
 - ▲ 120 volt models require RMB-GRAM-INF only, see page 80 for additional cost.
 - ▼ When using an infinite control with 120 volt model, additional switch(es) and tandem (end-to-end) elements are required.
 - ▶ Available with Remote Control Enclosure (RMB), RMB-GRAM-INF only, see page 80 for additional cost.
- Note:** Other control options available, consult factory.

All Glo-Ray Aluminum Max Watt Dual Infrared Models with Lights Feature:

Includes: Angle Brackets and Remote Control Enclosure (RMB).
Leads: 3' conduit with leads – server's right.
Dimensions: with 3" Spacer (standard): 15"D x 2½"H.
 with 6" Spacer: 18"D x 2½"H.

OPTIONS AND ACCESSORIES – PAGE 80
RECOMMENDED MOUNTING HEIGHTS – PAGE 94

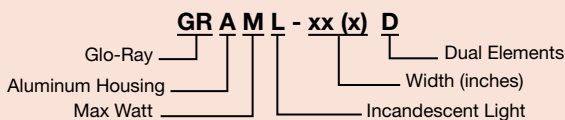

Strip Heaters



GRAML-60D with optional non-adjustable tubular stands

OPTIONS (available at time of purchase only)

Designer Colors, aluminum models 18"-144" – Non-standard colors are non-returnable – Clear Anodized standard –

COLOR-15, -18	15" and 18" Housings for GRAM and GRAML Dual models						per foot	\$46
	RED Warm Red	GRAY Gray Granite	NAVY Navy Blue	COPPER Antique Copper				
	BLACK Black	WHITE White Granite	GREEN Hunter Green					
RMB-COLOR	Remote Control Enclosure Housing in Designer Colors – Non-standard colors are non-returnable – Clear Anodized standard –							46
	RED Warm Red	GRAY Gray Granite	NAVY Navy Blue	COPPER Antique Copper				
	BLACK Black	WHITE White Granite	GREEN Hunter Green					

Gloss Finishes, aluminum models 18"-144" – Non-standard colors are non-returnable – Clear Anodized standard –

GLOSS-15, -18	15" and 18" Housings for GRAM and GRAML Dual models						per foot	\$59
	RRED Radiant Red	GGRAY Glossy Gray	BBLACK Bold Black					
	GGOLD Gleaming Gold	BBLUE Brilliant Blue						
RMB-GLOSS	Remote Control Enclosure Housing in Gloss Finishes							66
	RRED Radiant Red	GGRAY Glossy Gray	BBLACK Bold Black					
	GGOLD Gleaming Gold	BBLUE Brilliant Blue						

Power Leads – Extended beyond standard 3' Conduit (must specify lead length) –

HTLEADS5	1'-5' extended Electrical Leads							\$ 38
HTLEADS10	6'-10' extended Electrical Leads							76
HTLEADS15	11'-15' extended Electrical Leads							114
HTLEADS20	16'-20' extended Electrical Leads							152
RMB-GRAM-INF	Remote Control Enclosure with Toggle Control Switch, Electronic Infinite Control, Relay and Indicator Light (in lieu of standard Remote Control Enclosure)							448
3 ANEAL REFL	Bright Annealed Reflector for lights with 3" Spacer						per foot	27
6 ANEAL REFL	Bright Annealed Reflector for lights with 6" Spacer						per foot	40

Stands

NTL-18-D, -20-D	Non-Adjustable Tubular Stands (specify 18" or 20" clearance)						2 pair	258
NTL-22-D, -24-D	Non-Adjustable Tubular Stands (specify 22" or 24" clearance)						2 pair	279
NTL-PAINT-D	Designer Color or Gloss Finish for Non-Adjustable Tubular Stands to match unit color – Non-standard colors are non-returnable –						2 pair	90
HAL	60 Watt Halogen Bulb in lieu of standard Display Light						each	63
NO BULB	No bulb option (GRAML-xxD models only)							No Charge

ACCESSORIES (available for purchase at any time)

Chef LED 120V adjustable bulb – GRAML-xxD models only, all voltages – pass-through usage only – see page 63 for more information –							each	\$129
	GRAML-xxD must be 18" to 24" from surface as pass through – bulbs must be rotated down –							
CLED-2700-120	Similar to warm Incandescent	CLED-3000-120	Similar to warm Halogen light	CLED-4000-120	Similar to cool Fluorescent light			

COLORS AND FINISHES – INSIDE BACK COVER

Glo-Ray® Narrow Infrared Strip Heaters

Hatco Glo-Ray® Narrow Infrared Strip Heaters keep all hot foods at optimum serving temperatures longer, while the slim design fits ideally in buffet areas. Even the most delicate dishes hold that “just-prepared” look. The entire holding surface is heated evenly with no “cold” spots.

- Slim design that's 2" high and 4" deep
- Available in widths from 18"-72"
- Pre-focused heat pattern maintains serving temperatures longer without continuing to cook the food
- Optional Remote Control Enclosure (RMB) available in *Designer Colors*



GRN-24 in standard *Designer Black* with standard angle brackets

Toggle Switch: Max. 15 Amps
Infinite Switch: Max. 12.2 Amps

GLO-RAY NARROW INFRARED STRIP HEATERS

Model	Width	Voltage (Single Phase)	Watts	Ship Weight	List Price ^o
Standard Watt					
GRN-18	18"	120, 208 or 240	250	5 lbs.	\$411
GRN-24	24"	120, 208 or 240	350	6 lbs.	436
GRN-30	30"	120, 208 or 240	450	9 lbs.	463
GRN-36	36"	120, 208 or 240	575	9 lbs.	492
GRN-42	42"	120, 208 or 240	675	9 lbs.	522
GRN-48	48"	120, 208 or 240	800	11 lbs.	554
GRN-54	54"	120, 208 or 240	925	12 lbs.	586
GRN-60	60"	120, 208 or 240	1050	13 lbs.	628
GRN-66	66"	120, 208 or 240	1160	16 lbs.	687
GRN-72	72"	120, 208 or 240	1275	17 lbs.	777
High Watt					
GRNH-18	18"	120, 208 or 240	350	7 lbs.	\$419
GRNH-24	24"	120, 208 or 240	500	6 lbs.	444
GRNH-30	30"	120, 208 or 240	660	7 lbs.	471
GRNH-36	36"	120, 208 or 240	800	8 lbs.	500
GRNH-42	42"	120, 208 or 240	950	9 lbs.	530
GRNH-48	48"	120, 208 or 240	1100	11 lbs.	562
GRNH-54	54"	120, 208 or 240	1250	12 lbs.	594
GRNH-60	60"	120, 208 or 240	1400	13 lbs.	636
GRNH-66*	66"	120, 208 or 240	1560	16 lbs.	695
GRNH-72*	72"	120, 208 or 240	1725	17 lbs.	785

^o Does not include Remote Control Enclosure (RMB), see pages 96 and 97.
 ♦ Infinite Switch not available in 120V. RMB2-1R or RMB2-2R series Remote Control Enclosure (RMB) required.

All Glo-Ray Narrow Infrared models feature:
Toggle Switch (max. 15 Amps) with Indicator Light Location: Chef's left side (unless otherwise specified).
Designer Color Angle Brackets: To match unit color and provide 1½" clearance between strip heater and overshef. Non-standard colors are non-returnable.
Leads: 6" leads – server's right. **Dimensions:** 18"-72"W x 4"D x 2"H.

RECOMMENDED MOUNTING HEIGHTS – PAGE 94 COLORS AND FINISHES – INSIDE BACK COVER

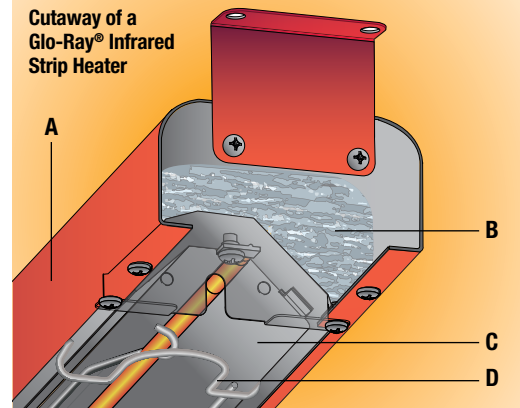

- A** Sturdy housing available in optional Stainless Steel or six optional *Designer Colors* (*Designer Black* standard)
- B** Heavy-duty insulation minimizes heat loss
- C** Aluminized reflector retains full heat intensity and directs more heat towards edges of holding surface
- D** Protective wire guard supports heating element without affecting heat distribution

Strip Heaters

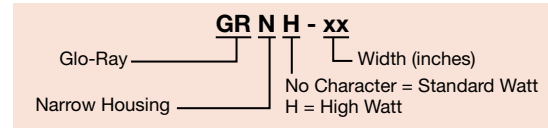

OPTIONS (available at time of purchase only)

Designer Colors, models 18"-72" – Non-standard colors are non-returnable – Black Standard –	No Charge
RED Warm Red WHITE White Granite GREEN Hunter Green	
GRAY Gray Granite NAVY Navy Blue COPPER Antique Copper	
Stainless Steel – Additional Charge – Non-standard colors are non-returnable –	per foot \$32
SS Stainless Steel	
Power Leads (must specify lead length) –	
LEADS5 1'-5' extended Electrical Leads	\$ 27
LEADS10 6'-10' extended Electrical Leads	54
LEADS15 11'-15' extended Electrical Leads	81
LEADS20 16'-20' extended Electrical Leads	108
NO CONTROL No control included – Requires selection of RMB2-xx control – see page 96	No Charge
RMB Remote Control Enclosure (available in <i>Designer Colors</i> or <i>Gloss Finishes</i>) – Non-standard colors are non-returnable –	see pages 96 and 97
TABS Stainless steel Hanger tabs in lieu of angle brackets	No Charge
CAP Attached 6' Cord and Plug Set (120V only) on models up to 72" with Standard Chain Mount Kit (two S Hooks with two 6" lengths of chain) and hanger tabs (max. 1800 Watt)	\$ 37
CHAIN-HOOK Two S Hooks with two 6" lengths of chain	each 14
NTL-10, -12 Non-Adjustable Tubular Stands (specify 10" or 12" clearance and power location)	1 pair 113
NTL-14, -16 Non-Adjustable Tubular Stands (specify 14" or 16" clearance and power location)	1 pair 121
NTL-PAINT <i>Designer Color</i> for Non-Adjustable Tubular Stands to match unit color – Non-standard colors are non-returnable –	1 pair 45



Glo-Ray® Narrow Max Watt Infrared Strip Heaters

Glo-Ray® Narrow Max Watt Infrared Strip Heaters keep all hot foods at optimum serving temperatures longer, while the slim design fits ideally in buffet areas. The entire holding surface is heated evenly with no “cold” spots.

- Slim design that's 2" high and 4" deep
- Available in widths from 18"-72"
- Pre-focused heat pattern maintains serving temperatures longer without continuing to cook the food
- Available in Stainless Steel only



GRNM-24 in standard Stainless Steel with standard angle brackets

GLO-RAY NARROW MAX WATT INFRARED STRIP HEATERS (must specify and add price of RMB)

Model	Width	Voltage (Single Phase)	Watts	Ship Weight	List Price ^o
GRNM-18	18"	120, 208 or 240	450	7 lbs.	\$469
GRNM-24	24"	120, 208 or 240	650	8 lbs.	507
GRNM-30	30"	120, 208 or 240	825	9 lbs.	548
GRNM-36	36"	120, 208 or 240	1000	10 lbs.	592
GRNM-42	42"	120, 208 or 240	1175	11 lbs.	638
GRNM-48	48"	120, 208 or 240	1300	13 lbs.	685
GRNM-54*	54"	120, 208 or 240	1500	13 lbs.	732
GRNM-60*	60"	120, 208 or 240	1700	13 lbs.	784
GRNM-66	66"	120, 208 or 240	1875	16 lbs.	853
GRNM-72	72"	120, 208 or 240	2075	16 lbs.	958

^o Does not include Remote Control Enclosure (RMB), see pages 96 and 97.

* Infinite Switch not available in 120V. RMB2-1R or RMB2-2R series Remote Control Enclosure (RMB) required.

All Glo-Ray Narrow Max Watt Infrared models feature:

Angle Brackets: Provides 1½" clearance between strip heater and oversheff.

Leads: 6" leads – server's right.

Dimensions: 18"-72"W x 4"D x 2"H.

RECOMMENDED MOUNTING HEIGHTS – PAGE 94

OPTIONS (available at time of purchase only)

Power Leads – Extended beyond Standard 6" Leads (must specify lead length) –

HTLEADS5	1'-5' extended Electrical Leads	\$ 38
HTLEADS10	6'-10' extended Electrical Leads	76
HTLEADS15	11'-15' extended Electrical Leads	114
HTLEADS20	16'-20' extended Electrical Leads	152
NO CONTROL	No control included – Requires selection of RMB2-xx control – see page 96	No Charge
RMB	Requires Remote Control Enclosure – Not available with Built-In controls	see pages 96 and 97
NTL-14, -16	Non-Adjustable Tubular Stands (specify 14" or 16" clearance and power location)	1 pair 121

GR N M - xx

Glo-Ray ———
Narrow Housing ———

Width (inches)
M = Max Wattage

Glo-Ray® Aluminum Infra-Black® High Watt Strip Heaters

For foodwarming at a close range to food product, the Glo-Ray® Infra-Black® heat technology is ideal, emitting a solid panel of uniform heat. Sturdy continuous single or dual extruded aluminum housings assure quality, durability and a variety of widths, depths, mounting arrangements and colors will fit your operation.

- Provides ideal amount of heat for limited space operations, mounted 4" to 10" above target surface for singles and 8" to 14" for duals
- Metal-sheathed heating element part guaranteed against burnout and breakage for two years
- Infra-Black emitter provides even heat distribution – eliminating hot spots
- Sturdy aluminum housings that do not sag, from 18" to 72" in 6" increments
- Heavy-duty insulation keeps the exterior housing cool
- Optional wire guard available to protect user from incidental contact with heated surface
- Optional 3" or 6" spacer available on dual models with or without lights (see next page)



GRAIH-36 with optional wire guard, requires TCBI or Remote Control Enclosure (RMB)

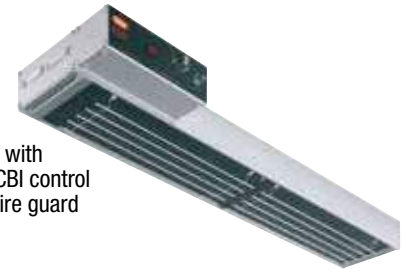

GRAIH-36 with optional TCBI control box and wire guard

Toggle Switch: Max. 15 Amps
Infinite Switch: Max. 12.2 Amps

GLO-RAY ALUMINUM INFRA-BLACK HIGH WATT STRIP HEATERS (must specify and add price of RMB or TCBI)

Model	Width	Voltage		Watts	Ship Weight [◇]	List Price [◇]
		Single Phase				
GRAIH-18	18"	120, 208 or 240		350	10 lbs.	\$533
GRAIH-24	24"	120, 208 or 240		500	11 lbs.	565
GRAIH-30	30"	120, 208 or 240		660	12 lbs.	601
GRAIH-36	36"	120, 208 or 240		800	13 lbs.	638
GRAIH-42	42"	120, 208 or 240		950	16 lbs.	676
GRAIH-48	48"	120, 208 or 240		1100	16 lbs.	715
GRAIH-54	54"	120, 208 or 240		1250	18 lbs.	753
GRAIH-60	60"	120, 208 or 240		1400	19 lbs.	802
GRAIH-66*	66"	120, 208 or 240		1560	23 lbs.	867
GRAIH-72*	72"	120, 208 or 240		1725	25 lbs.	985

GLO-RAY ALUMINUM INFRA-BLACK HIGH WATT STRIP HEATERS with LIGHTS (must specify and add price of RMB or TCBI)

Model	No. of Bulbs	Width	Voltage		Watts	Ship Weight [◇]	List Price [◇]
			Single Phase				
GRAIHL-18	2	18"	120, 120/208 or 120/240		470	12 lbs.	\$ 718
GRAIHL-24	2	24"	120, 120/208 or 120/240		620	14 lbs.	756
GRAIHL-30	2	30"	120, 120/208 or 120/240		780	16 lbs.	831
GRAIHL-36	3	36"	120, 120/208 or 120/240		980	18 lbs.	910
GRAIHL-42	3	42"	120, 120/208 or 120/240		1130	20 lbs.	993
GRAIHL-48	4	48"	120, 120/208 or 120/240		1340	22 lbs.	1075
GRAIHL-54	4	54"	120, 120/208 or 120/240		1490	24 lbs.	1156
GRAIHL-60	5	60"	120, 120/208 or 120/240		1700	26 lbs.	1260
GRAIHL-66*	5	66"	120, 120/208 or 120/240		1860	28 lbs.	1378
GRAIHL-72* [▲]	6	72"	120, 120/208 or 120/240		2085	30 lbs.	1533

- ◇ Does not include Remote Control Enclosure (RMB).
- ◇ Does not include Remote Control Enclosure (RMB) or Thermostatic Control Box with Indicator Lights (TCBI). Must choose either RMB (see pages 96 and 97) or TCBI (see OPTIONS on page 85).
- * Infinite Switch not available in 120V.
- ▲ 120V models available with remote control only.

All Glo-Ray Aluminum Infra-Black High Watt models with or without Lights feature:

Leads: 3' conduit with leads – server's right. 6" leads when supplied with TCBI – exit side of control box.

Dimensions: GRAIH: 18"-72"W x 6"D x 2½"H.

GRAIHL: 18"-72"W x 9"D x 2½"H.

TCBI Control Enclosure dimensions (not including switches): 8"W x 3"D x 2½"H.

Control Enclosure location: Chef's left side – light side (unless otherwise specified).

OPTIONS AND ACCESSORIES – PAGE 85

RECOMMENDED MOUNTING HEIGHTS – PAGE 94

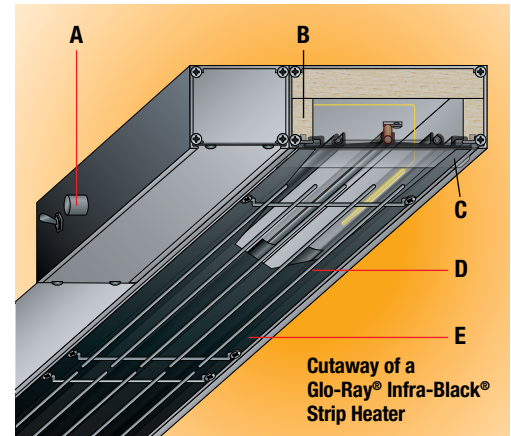

Cutaway of a Glo-Ray® Infra-Black® Strip Heater

- A** Thermostatically controlled to regulate heat and provide consistent temperature. (Optional Remote Control Enclosure (RMB) available)
- B** Heavy-duty insulation minimizes heat loss
- C** Provides ideal amount of heat for limited space operations, effectively holding product
- D** Optional wire guard available to protect user from incidental contact with the heated surface
- E** Infra-Black emitter provides even heat distribution, eliminating hot spots for close applications

Strip Heaters





Glo-Ray® Aluminum Infra-Black® High Watt Dual Strip Heaters

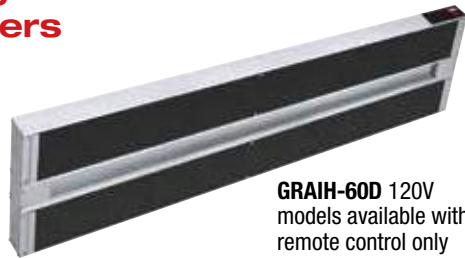

GRAIH-60D 120V models available with remote control only



GRAIHL-24D in optional Radiant Red Gloss Finish

Toggle Switch: Max. 15 Amps
Infinite Switch: Max. 12.2 Amps

GLO-RAY ALUMINUM INFRA-BLACK HIGH WATT DUAL STRIP HEATERS

(must specify and add price of RMB or TCBI)

Model	Width	Voltage		Watts	Ship Weight [◇]	List Price [○]	
		Single Phase				3" Spacer	6" Spacer
GRAIH-18D	18"	120, 208 or 240		700	13 lbs.	\$1227	\$1241
GRAIH-24D	24"	120, 208 or 240		1000	22 lbs.	1299	1313
GRAIH-30D	30"	120, 208 or 240		1320	22 lbs.	1407	1426
GRAIH-36D	36"	120, 208 or 240		1600	27 lbs.	1518	1537
GRAIH-42D [▲]	42"	120, 208 or 240		1900	35 lbs.	1633	1652
GRAIH-48D [▲]	48"	120, 208 or 240		2200	33 lbs.	1749	1775
GRAIH-54D [▲]	54"	120, 208 or 240		2500	41 lbs.	1867	1893
GRAIH-60D [▲]	60"	120, 208 or 240		2800	46 lbs.	2019	2059
GRAIH-66D ^{▲*}	66"	120, 208 or 240		3120	44 lbs.	2195	2235
GRAIH-72D ^{▲**}	72"	120, 208 or 240		3450	51 lbs.	2459	2499

GLO-RAY ALUMINUM INFRA-BLACK HIGH WATT DUAL STRIP HEATERS with LIGHTS

(must specify and add price of RMB or TCBI)

Model	No. of Bulbs	Width	Voltage		Watts	Ship Weight [◇]	List Price [○]	
			Single Phase				3" Spacer	6" Spacer
GRAIHL-18D	2	18"	120, 120/208 or 120/240		820	15 lbs.	\$1313	\$1327
GRAIHL-24D	2	24"	120, 120/208 or 120/240		1120	10 lbs.	1387	1401
GRAIHL-30D	2	30"	120, 120/208 or 120/240		1440	25 lbs.	1521	1540
GRAIHL-36D	3	36"	120, 120/208 or 120/240		1780	29 lbs.	1656	1675
GRAIHL-42D [▲]	3	42"	120, 120/208 or 120/240		2080	33 lbs.	1789	1808
GRAIHL-48D [▲]	4	48"	120, 120/208 or 120/240		2440	35 lbs.	1920	1946
GRAIHL-54D [▲]	4	54"	120, 120/208 or 120/240		2740	39 lbs.	2052	2078
GRAIHL-60D [▲]	5	60"	120, 120/208 or 120/240		3100	47 lbs.	2245	2285
GRAIHL-66D ^{▲**}	5	66"	120, 120/208 or 120/240		3420	45 lbs.	2453	2493

◇ Does not include Remote Control Enclosure (RMB).

○ Does not include Remote Control Enclosure (RMB) or Thermostatic Control Box with Indicator Lights (TCBI). Must choose either RMB (see pages 96 and 97) or TCBI (see OPTIONS on page 85).

▲ 120V models available with remote control only.

◇ Infinite Switch not available in 120V.

* TCBI not available in 208V, 120/208V.

All Glo-Ray Aluminum Infra-Black High Watt Dual with or without Lights models feature:

Leads: 3' conduit with leads – server's right. 6" leads when supplied with TCBI – exit side of control box.

Dimensions: GRAIH-xxD with 3" Spacer: 18"-72"W x 15"D x 2½"H.

GRAIHL-xxD with 3" Spacer: 18"-66"W x 15"D x 2½"H.

GRAIH-xxD with 6" Spacer: 18"-72"W x 18"D x 2½"H.

GRAIHL-xxD with 6" Spacer: 18"-66"W x 18"D x 2½"H.

TCBI Control Enclosure dimensions (not including switches): 8"W x 3"D x 2½"H.

Control Enclosure location: Chef's left side – light side (unless otherwise specified).

OPTIONS AND ACCESSORIES – PAGE 85

RECOMMENDED MOUNTING HEIGHTS – PAGE 94

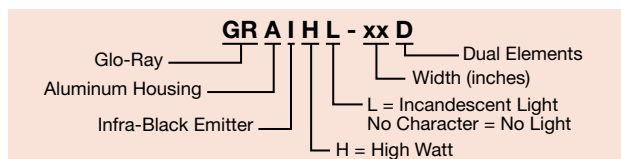



GRAIH-72 with optional wire guard, requires Remote Control Enclosure (RMB)

OPTIONS (available at time of purchase only)

Designer Colors – Non-standard colors are non-returnable – Clear Anodized Standard –

COLOR-6, -9	6" Housing for GRAIH models and 9" Housing for GRAIHL models	RED Warm Red	GRAY Gray Granite	NAVY Navy Blue	COPPER Antique Copper	per foot	\$32
		BLACK Black	WHITE White Granite	GREEN Hunter Green			
COLOR-15, -18	15" and 18" Housings for GRAIH and GRAIHL Dual models	RED Warm Red	GRAY Gray Granite	NAVY Navy Blue	COPPER Antique Copper	per foot	46
		BLACK Black	WHITE White Granite	GREEN Hunter Green			

Gloss Finishes – Non-standard colors are non-returnable – Clear Anodized Standard –

GLOSS-6, -9	6" Housing for GRAIH models and 9" Housing for GRAIHL models	RRED Radiant Red	GGRAY Glossy Gray	BBLACK Bold Black		per foot	\$44
		GGOLD Gleaming Gold	BBLUE Brilliant Blue				
GLOSS-15, -18	15" and 18" Housings for GRAIH and GRAIHL Dual models	RRED Radiant Red	GGRAY Glossy Gray	BBLACK Bold Black		per foot	59
		GGOLD Gleaming Gold	BBLUE Brilliant Blue				

AIH18WG -AIH72WG	Element Wire Guard (Dual models require two sets)	per foot (per side)	\$33
-------------------------	---	---------------------	------

HAL	60 Watt Halogen Bulb in lieu of Standard Display Light	each	63
------------	--	------	----

NO CONTROL	No control included (GRAIH, GRAIHL-xx, GRAIH, GRAIHL-xxD models only) Requires selection of RMB2-xx control – see page 96	No Charge	
-------------------	--	-----------	--

RMB	Remote Control Enclosure – available in <i>Designer Colors</i> or <i>Gloss Finishes</i> – Non-standard colors are non-returnable – Clear Anodized Standard –	see pages 96 and 97	
------------	--	---------------------	--

	RED Warm Red	GRAY Gray Granite	NAVY Navy Blue	COPPER Antique Copper			
	BLACK Black	WHITE White Granite	GREEN Hunter Green				
	RRED Radiant Red	GGRAY Glossy Gray	BBLACK Bold Black				
	GGOLD Gleaming Gold	BBLUE Brilliant Blue					

TCBI	Thermostatic Control Box with Indicator Lights		\$219
-------------	--	--	-------

Non-Adjustable Tubular Stands

AIH4NTL	4"	1 pair	113
AIH6NTL	6"	1 pair	113
AIH7.5NTL-D	7.5"	2 pair	227
AIH8NTL	8" (Dual models require two pair)	1 pair	113
AIH10NTL	10" (Dual models require two pair)	1 pair	113
AIH12NTL-D	12"	2 pair	227
AIH14NTL-D	14"	2 pair	242

NTL-PAINT	<i>Designer Color</i> or <i>Gloss Finish</i> for Non-Adjustable Tubular Stands to match unit color – Non-Standard colors are non-returnable –	1 pair	45
------------------	--	--------	----

NTL-PAINT-D	<i>Designer Color</i> or <i>Gloss Finish</i> for Non-Adjustable Tubular Stands to match unit color – Non-Standard colors are non-returnable –	2 pair	90
--------------------	--	--------	----

Power Leads (must specify lead length) –

HTLEADS5	1'-5' extended Electrical Leads	\$	38
HTLEADS10	6'-10' extended Electrical Leads		76
HTLEADS15	11'-15' extended Electrical Leads		114
HTLEADS20	16'-20' extended Electrical Leads		152

ACCESSORIES (available for purchase at any time)

ADJ ANGLE	Adjustable Angle Brackets (see page 95 for illustration)	1 pair	\$ 29
ADJ ANGLE7	7" tall Adjustable Angle Brackets (see page 95 for illustration)	1 pair	34
ADJ ANGLE-D	Adjustable Angle Brackets for Dual models (see page 95 for illustration)	2 pair	58
ADJ ANGLE7-D	7" tall Adjustable Angle Brackets for Dual models (see page 95 for illustration)	2 pair	68
CHAIN 1	Chain Suspension (see page 95 for illustration)	per foot	14

Chef LED 120V adjustable bulb – GRAIHL-xx models only, all voltages – pass-through usage only – see page 63 for more information –		each	129
	GRAIHL-xx must be 11" or higher from surface as pass through – bulbs must be rotated down –		
CLED-2700-120	Similar to warm Incandescent	CLED-3000-120	Similar to warm Halogen light
CLED-4000-120	Similar to cool Fluorescent light		

COLORS AND FINISHES – INSIDE BACK COVER

Strip Heaters



Glo-Ray® Designer Aluminum Infrared Strip Heaters

Hatco Glo-Ray Designer Aluminum Infrared Strip Heaters safely keep all hot foods at optimum serving temperatures longer. This modern design is ideal for front-of-the-house use. Units are offered in continuous housings, up to 84" (7'), are available in Designer Colors to match most décors and include 14" Designer non-adjustable stands.

- Pre-focused heat maintains safe serving temperatures longer without continuing to cook the food
- Available in widths from 21½" to 87½"
- Available in a variety of models, configurations, colors and accessories to provide unlimited flexibility
- Black corner caps and inset panels standard

- Optional coated shatter-resistant incandescent or halogen lights enhance product displays while safeguarding food from bulb breakage
- Optional Sneeze Guards
- Additional reflector styles and lower wattage elements available, consult factory for more information



GR2AH-36 with Designer non-adjustable stands (NTL) and optional Designer Warm Red inset panels

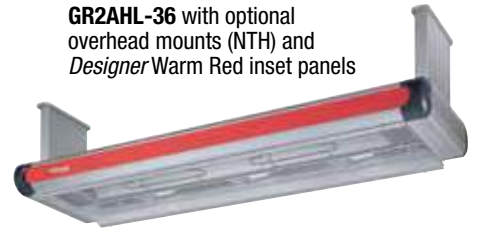

GR2AHL-36 with optional overhead mounts (NTH) and Designer Warm Red inset panels

Toggle Switch: Max. 15 Amps
Infinite Switch: Max. 12.2 Amps

GLO-RAY DESIGNER ALUMINUM INFRARED STRIP HEATERS (must specify and add price of RMB)

Model*	Width	Watts	Ship Weight [◇]	List Price [▷]
Standard Watt				
GR2A-18	21½"	250	19 lbs.	\$1306
GR2A-24	27½"	350	20 lbs.	1357
GR2A-30	33½"	450	27 lbs.	1412
GR2A-36	39½"	575	37 lbs.	1466
GR2A-42	45½"	675	38 lbs.	1522
GR2A-48	51½"	800	43 lbs.	1577
GR2A-54	57½"	925	43 lbs.	1636
GR2A-60	63½"	1050	40 lbs.	1711
GR2A-66	69½"	1160	40 lbs.	1788
GR2A-72	75½"	1275	42 lbs.	1898
GR2A-84 [▼]	87½"	1500	46 lbs.	2195
High Watt				
GR2AH-18	21½"	350	20 lbs.	\$1314
GR2AH-24	27½"	500	20 lbs.	1365
GR2AH-30	33½"	660	27 lbs.	1420
GR2AH-36	39½"	800	27 lbs.	1474
GR2AH-42	45½"	950	34 lbs.	1530
GR2AH-48	51½"	1100	27 lbs.	1585
GR2AH-54	57½"	1250	43 lbs.	1644
GR2AH-60	63½"	1400	40 lbs.	1719
GR2AH-66 [▼]	69½"	1560	40 lbs.	1796
GR2AH-72 [▼]	75½"	1725	42 lbs.	1906
GR2AH-84 [▲]	87½"	2050	46 lbs.	2211

- When no color is specified, color inset panels and corner caps will be black.
- ◇ Does not include Remote Control Enclosure (RMB).
- ▷ Does not include Remote Control Enclosure (RMB). Must choose RMB (see pages 96 and 97).
- ▼ When using an infinite control with 120 volt model, additional switch(es) and tandem (end-to-end) elements required.
- ▲ 120 volt models require additional switches and tandem (end-to-end) elements.

All Glo-Ray Designer Aluminum Infrared models feature:

Voltage: 120, 208 or 240, single phase only.
Switch Location: Remote Control Enclosure (RMB) only (see pages 96 and 97).
Leads: 5' leads through ½" conduit in leg cavity.
Dimensions without stands: 21½"-87½"W x 9"D x 3½"H.

OPTIONS AND ACCESSORIES – PAGE 88 RECOMMENDED MOUNTING HEIGHTS – PAGE 94

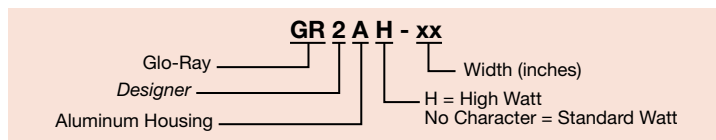

Glo-Ray® Designer Aluminum Infrared Strip Heaters with Lights



GR2AHL-24 with *Designer* non-adjustable stands optional Sneeze Guards and *Designer* Hunter Green inset panels

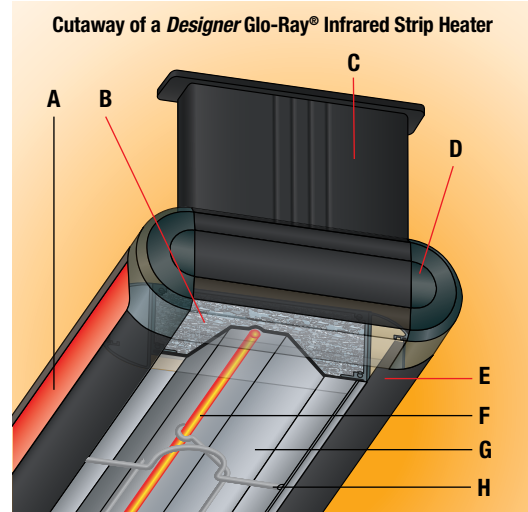

- A** Choice of seven *Designer* Color inset panels and attractive styling for front-of-the-house applications
- B** Heavy-duty insulation minimizes heat loss
- C** Non-adjustable stand conceals the power wiring, available for counter or overhead mounting
- D** Accent color corners available in Dark Gray or Black (standard)
- E** Sturdy aluminium extrusion construction; available in Clear Anodized aluminum finish or one of seven *Designer* Colors for housings (shown in optional *Designer* Black)
- F** Metal-sheathed heating element part guaranteed against burnout and breakage for two years
- G** Aluminized Reflectors won't discolor, so heat can be reflected and directed to the food product being held
- H** Protective wire guard supports heating element without affecting heat distribution

Strip Heaters

GLO-RAY DESIGNER ALUMINUM INFRARED STRIP HEATERS with LIGHTS
(must specify and add price of RMB)

Model*	No. of Bulbs	Width	Watts	Ship Weight*	List Price*
Standard Watt					
GR2AL-18	2	21½"	370	24 lbs.	\$1487
GR2AL-24	2	27½"	470	24 lbs.	1546
GR2AL-30	2	33½"	570	29 lbs.	1635
GR2AL-36	3	39½"	755	33 lbs.	1733
GR2AL-42	3	45½"	855	35 lbs.	1834
GR2AL-48	4	51½"	1040	36 lbs.	1938
GR2AL-54	4	57½"	1165	49 lbs.	2044
GR2AL-60	5	63½"	1350	54 lbs.	2155
GR2AL-66	5	69½"	1460	57 lbs.	2275
GR2AL-72	6	75½"	1635	58 lbs.	2425
GR2AL-84*	7	87½"	1920	62 lbs.	2623
High Watt					
GR2AHL-18	2	21½"	470	26 lbs.	\$1495
GR2AHL-24	2	27½"	620	24 lbs.	1554
GR2AHL-30	2	33½"	780	29 lbs.	1643
GR2AHL-36	3	39½"	980	33 lbs.	1741
GR2AHL-42	3	45½"	1130	35 lbs.	1842
GR2AHL-48	4	51½"	1340	48 lbs.	1946
GR2AHL-54	4	57½"	1490	49 lbs.	2052
GR2AHL-60	5	63½"	1700	54 lbs.	2163
GR2AHL-66*	5	69½"	1860	57 lbs.	2283
GR2AHL-72*	6	75½"	2085	58 lbs.	2433
GR2AHL-84*	7	87½"	2470	62 lbs.	2631

- * When no color is specified, color inset panels and corner caps will be black.
- † Does not include Remote Control Enclosure (RMB).
- ‡ Does not include Remote Control Enclosure (RMB). Must choose RMB (see pages 96 and 97).
- § When using an infinite control with 120 volt model, additional switch(es) and tandem (end-to-end) elements required.
- ▲ 120 volt models require additional switches and tandem (end-to-end) elements.

All Glo-Ray Designer Aluminum Infrared with Lights models feature:

Voltage: 120, 120/208 or 120/240, single phase only.
Switch Location: Remote Control Enclosure (RMB) only (see pages 96 and 97).
Leads: 5' leads through ½" conduit in leg cavity.
Dimensions without stands: 21½"-87½"W x 12"D x 3½"H.

OPTIONS AND ACCESSORIES – PAGE 88
RECOMMENDED MOUNTING HEIGHTS – PAGE 94

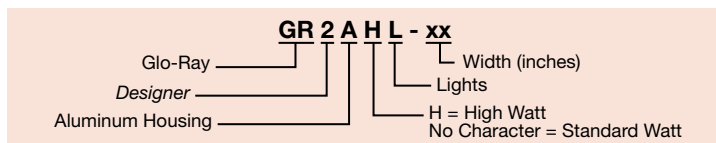



GR2AHL-84 with standard Designer non-adjustable stands and optional Designer Black and Sneeze Guards

OPTIONS (available at time of purchase only)

Designer Colors, aluminum models 21½"- 87½" (includes stands) – Non-standard colors are non-returnable – Clear Anodized Standard –

COLOR-6 9" Housing for GR2A and GR2AH models **per foot \$32**

RED Warm Red **GRAY** Gray Granite **NAVY** Navy Blue **COPPER** Antique Copper
BLACK Black **WHITE** White Granite **GREEN** Hunter Green

COLOR-9 12" Housing for GR2AL and GR2AHL models **per foot 32**

RED Warm Red **GRAY** Gray Granite **NAVY** Navy Blue **COPPER** Antique Copper
BLACK Black **WHITE** White Granite **GREEN** Hunter Green

Designer Inset Panel Colors – Black standard – Non-standard colors are non-returnable – No Charge

RED Warm Red **WHITE** White Granite **GREEN** Hunter Green
GRAY Gray Granite **NAVY** Navy Blue **COPPER** Antique Copper

Designer Corner Caps – Black standard –

DKGRAY Dark Gray Corner Caps **No Charge**

NO CONTROL No control included (GR2A, GR2AH, GR2AL, GR2AHL models only), requires selection of RMB2-xx control – see page 96 **No Charge**

RMB Must choose Remote Control Enclosure (not included) **see pages 96 and 97**

Designer Remote Control Enclosures – Non-standard colors are non-returnable – Clear Anodized Standard –

RMB-COLOR Remote Control Enclosure Housing in Designer Color **\$46**

RED Warm Red **GRAY** Gray Granite **NAVY** Navy Blue **COPPER** Antique Copper
BLACK Black **WHITE** White Granite **GREEN** Hunter Green

7.5BP1 7½" Sneeze Guard one side **per foot \$ 71**

7.5BP2 7½" Sneeze Guard two sides **per foot 142**

14BP1 14" Sneeze Guard one side **per foot 113**

14BP2 14" Sneeze Guard two sides **per foot 226**

NTL2-10, -12, -16 Designer Color Non-Adjustable Stands to match unit color: 10", 12" or 16" in lieu of 14" Standard Stands – Non-Standard colors are non-returnable – **No Charge**

NTH2-4 4" Designer Color Overhead Mounts in lieu of 14" Standard Legs to match unit color – Non-Standard colors are non-returnable – **No Charge**

HAL 60 Watt Halogen Bulb in lieu of standard Display Light **each 63**

NO BULB No bulb option (GR2AL, GR2AHL models only) **No Charge**

LIGHTS-ADD'L Extra Lamps – Installed (max. two per ft. less one – one per ft. is Standard) **each 32**

Power Leads (must specify lead length) –

LEADS5 1'-5' extended Electrical Leads **\$27**

LEADS10 6'-10' extended Electrical Leads **54**

LEADS15 11'-15' extended Electrical Leads **81**

LEADS20 16'-20' extended Electrical Leads **108**

ACCESSORIES (available for purchase at any time)

Chef LED 120V adjustable bulb – GR2AL, GR2AHL models only, all voltages – see page 63 for more information – each \$129

GR2AHL requires pass-through usage only and unit must be 10" or higher from surface – bulbs must be rotated down –

CLED-2700-120 Similar to warm Incandescent **CLED-3000-120** Similar to warm Halogen light **CLED-4000-120** Similar to cool Fluorescent light

COLORS AND FINISHES – INSIDE BACK COVER

Chef LED Bulb



Glo-Ray® Designer Aluminum Infrared Dual Strip Heaters

Glo-Ray Designer Aluminum Infrared Dual Strip Heaters allow side-by-side mounting of two warmers to provide a deeper holding area, keeping hot food at optimum serving temperatures. These modern front-of-the-house warmers have 3" spacers standard with optional 6" spacers. Units are available in Designer colors to match most décors.

- Sturdy continuous aluminum housings eliminate sagging
- Pre-focused heat pattern directs heat from a tubular element to bathe the entire holding surface, holding food safely
- Available in widths from 21½" to 87½"
- Variety of models, configurations, colors and accessories provide unlimited flexibility. Non-standard colors are non-returnable
- Optional Sneeze Guards that meet food safety standards can be ordered for display areas and buffet lines
- Optional shatter-resistant incandescent lights available
- Black corner caps and inset panels standard
- Additional reflector styles and lower wattage elements available, consult factory for more information



GR2AH-24D with standard Designer non-adjustable stands, optional Sneeze Guards and optional Designer Navy Blue inset panels



GR2AHL-48D with standard Designer non-adjustable stands and optional Designer Warm Red inset panels

Toggle Switch: Max. 15 Amps
Infinite Switch: Max. 12.2 Amps

GLO-RAY DESIGNER ALUMINUM INFRARED DUAL STRIP HEATERS (must specify and add price of RMB)

Model*	Width	Watts	Ship Weight †	List Price †	
				3" Spacer	6" Spacer
Standard Watt					
GR2A-18D	21½"	500	28 lbs.	\$1889	\$1903
GR2A-24D	27½"	700	31 lbs.	1963	1977
GR2A-30D	33½"	900	37 lbs.	2075	2094
GR2A-36D	39½"	1150	37 lbs.	2191	2210
GR2A-42D	45½"	1350	41 lbs.	2309	2328
GR2A-48D	51½"	1600	45 lbs.	2426	2452
GR2A-54D	57½"	1850	52 lbs.	2545	2571
GR2A-60D	63½"	2100	60 lbs.	2696	2722
GR2A-66D	69½"	2320	70 lbs.	2849	2889
GR2A-72D	75½"	2550	63 lbs.	3076	3116
GR2A-84D*	87½"	3000	84 lbs.	3344	3398
High Watt					
GR2AH-18D	21½"	700	29 lbs.	\$1905	\$1919
GR2AH-24D	27½"	1000	29 lbs.	1979	1993
GR2AH-30D	33½"	1320	37 lbs.	2091	2110
GR2AH-36D	39½"	1600	37 lbs.	2207	2226
GR2AH-42D	45½"	1900	48 lbs.	2325	2344
GR2AH-48D	51½"	2200	55 lbs.	2442	2468
GR2AH-54D	57½"	2500	60 lbs.	2561	2587
GR2AH-60D	63½"	2800	55 lbs.	2712	2752
GR2AH-66D*	69½"	3120	64 lbs.	2865	2905
GR2AH-72D*	75½"	3450	61 lbs.	3092	3132
GR2AH-84D*	87½"	4100	106 lbs.	3360	3414

- When no color is specified, color inset panels and corner caps will be black.
- † Does not include Remote Control Enclosure (RMB).
- ‡ Does not include Remote Control Enclosure (RMB). Must choose RMB, see pages 96, 97.
- Infinite Switch not available in 120V.
- 120 volt models not available.

All Glo-Ray Designer Aluminum Infrared Dual models feature:
Voltage: Models Without Lights: 120, 208 or 240, single phase only.
Switch Location: Remote Control Enclosure (RMB) only (see pages 96, 97).
Leads: 5' leads through ½" conduit in leg cavity.
Dimensions: with 3" Spacer (standard): 21½"-87½"W x 18"D x 3½"H.
with 6" Spacer: 21½"-87½"W x 21"D x 3½"H.

OPTIONS AND ACCESSORIES – PAGE 90
RECOMMENDED MOUNTING HEIGHTS – PAGE 94

GLO-RAY DESIGNER ALUMINUM INFRARED DUAL STRIP HEATERS with LIGHTS (must specify and add price of RMB)

Model*	No. of Bulbs	Width	Watts	Ship Weight †	List Price †	
					3" Spacer	6" Spacer
Standard Watt						
GR2AL-18D	2	21½"	620	32 lbs.	\$1979	\$1993
GR2AL-24D	2	27½"	820	32 lbs.	2054	2068
GR2AL-30D	2	33½"	1020	35 lbs.	2184	2203
GR2AL-36D	3	39½"	1330	40 lbs.	2326	2345
GR2AL-42D	3	45½"	1530	46 lbs.	2460	2479
GR2AL-48D	4	51½"	1840	47 lbs.	2599	2625
GR2AL-54D	4	57½"	2090	50 lbs.	2739	2765
GR2AL-60D	5	63½"	2400	55 lbs.	2921	2961
GR2AL-66D	5	69½"	2620	67 lbs.	3107	3147
GR2AL-72D	6	75½"	2910	75 lbs.	3359	3399
GR2AL-84D*	7	87½"	3420	82 lbs.	3694	3748
High Watt						
GR2AHL-18D	2	21½"	820	32 lbs.	\$1995	\$2009
GR2AHL-24D	2	27½"	1120	32 lbs.	2070	2084
GR2AHL-30D	2	33½"	1440	35 lbs.	2200	2219
GR2AHL-36D	3	39½"	1780	40 lbs.	2342	2361
GR2AHL-42D	3	45½"	2080	46 lbs.	2476	2495
GR2AHL-48D	4	51½"	2440	47 lbs.	2615	2641
GR2AHL-54D	4	57½"	2740	50 lbs.	2755	2781
GR2AHL-60D	5	63½"	3100	55 lbs.	2937	2977
GR2AHL-66D*	5	69½"	3420	67 lbs.	3123	3163
GR2AHL-72D*	6	75½"	3810	75 lbs.	3375	3415
GR2AHL-84D*	7	87½"	4520	82 lbs.	3710	3764

- When no color is specified, color inset panels and corner caps will be black.
- † Does not include Remote Control Enclosure (RMB).
- ‡ Does not include Remote Control Enclosure (RMB). Must choose RMB, see pages 96, 97.
- Infinite Switch not available in 120V.
- 120 volt models not available.

All Glo-Ray Designer Aluminum Infrared Dual with Lights models feature:
Voltage: Models With Lights: 120, 120/208 or 120/240, single phase only.
Switch Location: Remote Control Enclosure (RMB) only (see pages 96, 97).
Leads: 5' leads through ½" conduit in leg cavity.
Dimensions: with 3" Spacer (standard): 21½"-87½"W x 18"D x 3½"H.
with 6" Spacer: 21½"-87½"W x 21"D x 3½"H.

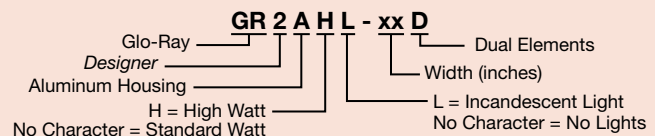



GR2AHL-30D

OPTIONS (available at time of purchase only)

Designer Colors, aluminum models 21½"- 87½" (includes stands) – Non-standard colors are non-returnable – Clear Anodized standard –

COLOR-15, -18	15" and 18" Housings for GR2A, GR2AH, GR2AL and GR2AHL Dual models						per foot	\$46
RED	Warm Red	GRAY	Gray Granite	NAVY	Navy Blue	COPPER	Antique Copper	
BLACK	Black	WHITE	White Granite	GREEN	Hunter Green			

Designer Inset Panel Colors – Black standard –

RED	Warm Red	WHITE	White Granite	GREEN	Hunter Green		No Charge
GRAY	Gray Granite	NAVY	Navy Blue	COPPER	Antique Copper		

Designer Corner Caps – Black standard –

DKGRAY	Dark Gray Corner Caps						No Charge
---------------	-----------------------	--	--	--	--	--	------------------

NO CONTROLS No control included (GR2A, GR2AH, GR2AL, GR2AHL-xxD models only), requires selection of RMB2-xx control – see page 96 **No Charge**

RMB Remote Control Enclosure – available in *Designer Colors* or *Gloss Finishes* – Non-standard colors are non-returnable – Clear Anodized standard – (must choose a Remote Control Enclosure - not included) **see pages 96 and 97**

RED	Warm Red	GRAY	Gray Granite	NAVY	Navy Blue	COPPER	Antique Copper
BLACK	Black	WHITE	White Granite	GREEN	Hunter Green		
RRED	Radiant Red	GGRAY	Glossy Gray	BBLACK	Bold Black		
GGOLD	Gleaming Gold	BBLUE	Brilliant Blue				

Designer Remote Control Enclosures – Non-standard colors are non-returnable –

RMB-COLOR Remote Control Enclosure Housing in *Designer Color* **\$46**

RED	Warm Red	GRAY	Gray Granite	NAVY	Navy Blue	COPPER	Antique Copper
BLACK	Black	WHITE	White Granite	GREEN	Hunter Green		

7.5BP1 7½" Sneeze Guard one side **per foot \$ 71**

7.5BP2 7½" Sneeze Guard two sides **per foot 142**

14BP1 14" Sneeze Guard one side **per foot 113**

14BP2 14" Sneeze Guard two sides **per foot 226**

NTL2-10, -12, -16 *Designer* Non-Adjustable Stands: 10", 12" or 16" in lieu of 14" Standard Stands to match unit color – Non-Standard colors are non-returnable – **No Charge**

NTH2-4 4" *Designer* Overhead Mounts in lieu of 14" Standard Stands to match unit color – Non-Standard colors are non-returnable – **No Charge**

HAL 60 Watt Halogen Bulb in lieu of Standard Display Light **each \$63**

NO BULB No bulb option (GR2AL-xxD, GR2AHL-xxD models only) **No Charge**

LIGHTS-ADD'L Extra Lamps – Installed (max. two per ft. less one – one per ft. is Standard) **each 32**

Power Leads (must specify lead length) –

LEADS5	1'-5' extended Electrical Leads	\$27
LEADS10	6'-10' extended Electrical Leads	54
LEADS15	11'-15' extended Electrical Leads	81
LEADS20	16'-20' extended Electrical Leads	108

ACCESSORIES (available for purchase at any time)

Chef LED 120V adjustable bulb – GR2AL-xxD, GR2AHL-xxD models only, all voltages – see page 63 for more information – **each \$129**

GR2AL-xxD requires pass-through usage only and unit must be 15" or higher from surface
 GR2AHL-xxD requires pass-through usage only and unit must be 18" or higher from surface
 Bulbs must be rotated down –

CLED-2700-120 Similar to warm Incandescent **CLED-3000-120** Similar to warm Halogen light **CLED-4000-120** Similar to cool Fluorescent light

COLORS AND FINISHES – INSIDE BACK COVER

Ultra-Glo® Aluminum Ceramic Infrared Strip Heaters

Hatco Ultra-Glo Aluminum Ceramic Infrared Strip Heaters provide the ultimate holding power. Increased heights improve working clearances and the heat zone blankets the entire holding area. All models include adjustable angle brackets for mounting. Available with or without lights, with Attached or Remote Control Enclosure (recommended).



UGAH-18 in optional Gloss Finish, requires Remote Control Enclosure (RMB), not shown

- Pre-focused pyramidal heat pattern concentrates the heat at the edges where heat loss is greatest
- Increased height that the ceramic heat source affords improves operational working clearances, giving the chef and server an improved ergonomic environment in which to work
- Adaptable to many locations and configurations, including back- or front-of-the-house use, open kitchen concepts or buffet lines
- Available in widths from 18" to 72" in 6" increments
- Optional coated shatter-resistant incandescent or halogen bulbs enhance product display while safeguarding food from bulb breakage

Ultra-Glo® Ceramic Infrared Strip Heater Cutaway

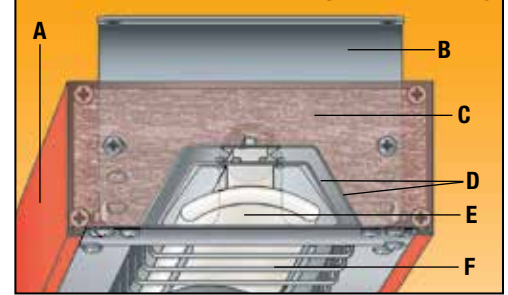

- A** Sturdy aluminum housings that do not sag
- B** Adjustable standard mounting bracket (allows 3 different mounting heights and allows for conduit connection to end of the unit)
- C** Heavy-duty insulation surrounds heating element to keep exterior housing cooler and minimize heat loss
- D** Dual aluminized steel reflector keeps housing cooler, focuses more heat towards the food
- E** Shape of element focuses heat on the food
- F** Protective wire guards under heating element

ULTRA-GLO ALUMINUM CERAMIC INFRARED STRIP HEATERS

Model	Width	Voltage Single Phase	Watts	Ship Weight*	List Price*
Standard Watt					
UGA-18	18"	120, 208 or 240	500, 490 or 500	9 lbs.	\$ 784
UGA-24	24"	120, 208 or 240	650, 675 or 650	10 lbs.	795
UGA-30	30"	120, 208 or 240	750, 840 or 900	14 lbs.	957
UGA-36	36"	120, 208 or 240	1000, 980 or 1000	15 lbs.	968
UGA-42	42"	120, 208 or 240	1000, 1120 or 1200	17 lbs.	1127
UGA-48	48"	120, 208 or 240	1500, 1470 or 1500	19 lbs.	1138
UGA-54	54"	208 or 240	1470 or 1500	20 lbs.	1289
UGA-60	60"	208 or 240	1960 or 2000	22 lbs.	1301
UGA-66	66"	208 or 240	1960 or 2000	25 lbs.	1455
UGA-72	72"	208 or 240	1960 or 2000	25 lbs.	1488

Model	Width	Voltage Single Phase	Watts	Ship Weight*	List Price*
High Watt					
UGAH-18	18"	120, 208 or 240	650, 675 or 650	10 lbs.	\$ 792
UGAH-24	24"	120, 208 or 240	750, 750 or 750	9 lbs.	803
UGAH-30	30"	120, 208 or 240	1125, 1125 or 1125	12 lbs.	965
UGAH-36	36"	120, 208 or 240	1300, 1350 or 1300	15 lbs.	976
UGAH-42	42"	120, 208 or 240	1500, 1500 or 1500	16 lbs.	1135
UGAH-48	48"	208 or 240	2025 or 1950	19 lbs.	1146
UGAH-54	54"	208 or 240	2250 or 2250	20 lbs.	1297
UGAH-60	60"	208 or 240	2700 or 2600	24 lbs.	1309
UGAH-66	66"	208 or 240	2700 or 2600	23 lbs.	1463
UGAH-72	72"	208 or 240	3000 or 3000	25 lbs.	1496

All Ultra-Glo Aluminum Ceramic Infrared models feature:
Models Shipped With: Angle Brackets and Leads (3' conduit whip).
Dimensions With Attached Control Box, Toggle and Indicator Light: 18"-72"W x 9 7/8"D x 2 1/2"H.
Dimensions With Remote Control Enclosure (RMB), Toggle and Indicator Light: 18"-72"W x 6"D x 2 1/2"H.

OPTIONS – PAGE 93
RECOMMENDED MOUNTING HEIGHTS – PAGE 94
REMOTE CONTROL ENCLOSURES (RMB) – PAGE 97

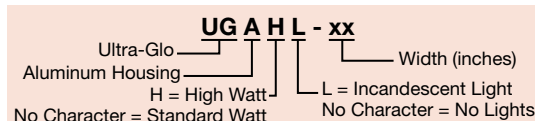

ULTRA-GLO ALUMINUM CERAMIC INFRARED STRIP HEATERS with LIGHTS

Model	No. of Bulbs	Width	Voltage Single Phase	Watts	Ship Weight*	List Price*
Standard Watt						
UGAL-18	1	18"	120, 120/208 or 120/240	560, 550 or 560	11 lbs.	\$ 961
UGAL-24	2	24"	120, 120/208 or 120/240	770, 795 or 770	10 lbs.	979
UGAL-30	2	30"	120, 120/208 or 120/240	870, 960 or 1020	15 lbs.	1177
UGAL-36	3	36"	120, 120/208 or 120/240	1180, 1160 or 1180	19 lbs.	1225
UGAL-42	3	42"	120, 120/208 or 120/240	1380, 1300 or 1380	21 lbs.	1414
UGAL-48	4	48"	120, 120/208 or 120/240	1740, 1710 or 1740	22 lbs.	1462
UGAL-54	4	54"	120/208 or 120/240	1710 or 1740	26 lbs.	1654
UGAL-60	5	60"	120/208 or 120/240	2260 or 2300	30 lbs.	1713
UGAL-66	5	66"	120/208 or 120/240	2260 or 2300	31 lbs.	1892
UGAL-72	6	72"	120/208 or 120/240	2320 or 2360	32 lbs.	1952

Model	No. of Bulbs	Width	Voltage Single Phase	Watts	Ship Weight*	List Price*
High Watt						
UGAHL-18	1	18"	120, 120/208 or 120/240	710, 735, or 710	12 lbs.	\$ 969
UGAHL-24	2	24"	120, 120/208 or 120/240	870, 870 or 870	12 lbs.	987
UGAHL-30	2	30"	120, 120/208 or 120/240	1245, 1245 or 1245	18 lbs.	1185
UGAHL-36	3	36"	120, 120/208 or 120/240	1480, 1530 or 1480	17 lbs.	1233
UGAHL-42	3	42"	120, 120/208 or 120/240	1680, 1680 or 1680	20 lbs.	1422
UGAHL-48	4	48"	120/208 or 120/240	2265 or 2190	23 lbs.	1470
UGAHL-54	4	54"	120/208 or 120/240	2490 or 2490	25 lbs.	1662
UGAHL-60*	5	60"	120/208 or 120/240	3000 or 2900	27 lbs.	1721
UGAHL-66*	5	66"	120/208 or 120/240	3000 or 2900	30 lbs.	1900
UGAHL-72*	6	72"	120/208 or 120/240	3360 or 3360	32 lbs.	1960

* Does not include Remote Control Enclosure (RMB).
 * Includes either Attached Control or Remote Control Enclosure (RMB) with toggle switch(es) and indicator light(s).
 * UGAHL-60, -66, -72 in 120/208 and UGAHL-72 in 120/240 require Remote Control Enclosure (RMB) with a Fuse.

All Ultra-Glo Aluminum Ceramic Infrared models with Lights feature:
Models Shipped With: Angle Brackets and Leads (3' conduit whip).
Dimensions With Attached Control Box, Toggle and Indicator Light: 18"-72"W x 12 1/8"D x 2 1/2"H.
Dimensions With Remote Control Enclosure (RMB), Toggle and Indicator Light: 18"-72"W x 9"D x 2 1/2"H.

OPTIONS AND REMOTE CONTROL ENCLOSURES (RMB) – PAGE 93
RECOMMENDED MOUNTING HEIGHTS – PAGE 94



Ultra-Glo® Aluminum Ceramic Infrared Dual Strip Heaters

Hatco Ultra-Glo Ceramic Strip Heaters provide the ultimate holding power. Increased height improves working clearances and the heat zone blankets the entire holding area. All models include adjustable angle brackets for mounting. Dual mounted strip heaters accommodate wider food holding areas.

- Increased height improves operational working clearances, giving chef and server an improved ergonomic environment in which to work
- Adaptable to any location and configuration, including back- or front-of-the-house use, open kitchen concepts or buffet lines
- Pre-focused heat pattern provides an increased pyramidal dimension, concentrating heat at the edges where heat loss is the greatest

- Available in widths from 18" to 72"
- Remote Control Enclosure (RMB) with toggle switch, indicator light and wiring for convenient control placement
- Sturdy extruded aluminum housings eliminate sagging



UGAHL-60D with lights in optional Gloss Finish and Standard a 3" spacer - Remote Control Enclosure (RMB) required, not shown

ULTRA-GLO ALUMINUM CERAMIC INFRARED DUAL STRIP HEATERS

Model	Width	Voltage Single Phase	Watts	Ship Weight [†]	List Price*	List Price*
Standard Watt						
UGA-18D	18"	120, 208 or 240	1000, 980 or 1000	17 lbs.	\$1557	\$1571
UGA-24D	24"	120, 208 or 240	1300, 1350 or 1300	20 lbs.	1623	1637
UGA-30D	30"	120, 208 or 240	1500, 1680 or 1800	26 lbs.	1969	1988
UGA-36D	36"	208 or 240	1960 or 2000	31 lbs.	2034	2053
UGA-42D	42"	208 or 240	2240 or 2400	32 lbs.	2383	2402
UGA-48D	48"	208 or 240	2940 or 3000	40 lbs.	2445	2471
UGA-54D	54"	208 or 240	2940 or 3000	42 lbs.	2787	2813
UGA-60D	60"	208 or 240	3920 or 4000	49 lbs.	2861	2901
UGA-66D	66"	208 or 240	3920 or 4000	50 lbs.	3199	3239
UGA-72D	72"	208 or 240	3920 or 4000	52 lbs.	3298	3338
High Watt						
UGAH-18D	18"	120, 208 or 240	1300, 1350 or 1300	17 lbs.	\$1573	\$1587
UGAH-24D	24"	120, 208 or 240	1500, 1500 or 1500	20 lbs.	1639	1653
UGAH-30D	30"	208 or 240	2250, 2250	24 lbs.	1985	2004
UGAH-36D	36"	208 or 240	2700 or 2600	31 lbs.	2050	2069
UGAH-42D	42"	208 or 240	3000 or 3000	32 lbs.	2399	2418
UGAH-48D	48"	208 or 240	4050 or 3900	40 lbs.	2461	2487
UGAH-54D	54"	208 or 240	4500 or 4500	33 lbs.	2803	2829
UGAH-60D	60"	208 or 240	5400 or 5200	48 lbs.	2877	2917
UGAH-66D	66"	208 or 240	5400 or 5200	50 lbs.	3215	3255
UGAH-72D	72"	208 or 240	6000 or 6000	55 lbs.	3314	3354

ULTRA-GLO ALUMINUM CERAMIC INFRARED DUAL STRIP HEATERS with LIGHTS

Model	No. of Bulbs	Width	Voltage Single Phase	Watts	Ship Weight [†]	List Price*	List Price*
Standard Watt							
UGAL-18D	1	18"	120, 120/208 or 120/240	1060, 1040 or 1060	18 lbs.	\$1632	\$1646
UGAL-24D	2	24"	120, 120/208 or 120/240	1420, 1470 or 1420	21 lbs.	1664	1678
UGAL-30D	2	30"	120, 120/208 or 120/240	1620, 1800 or 1920	26 lbs.	2074	2093
UGAL-36D	3	36"	120/208 or 120/240	2140 or 2180	30 lbs.	2165	2184
UGAL-42D	3	42"	120/208 or 120/240	2420 or 2580	35 lbs.	2548	2567
UGAL-48D	4	48"	120/208 or 120/240	3180 or 3240	30 lbs.	2631	2657
UGAL-54D	4	54"	120/208 or 120/240	3180 or 3240	41 lbs.	3011	3037
UGAL-60D	5	60"	120/208 or 120/240	4220 or 4300	50 lbs.	3098	3138
UGAL-66D	5	66"	120/208 or 120/240	4220 or 4300	51 lbs.	3463	3503
UGAL-72D	6	72"	120/208 or 120/240	4280 or 4360	56 lbs.	3586	3626
High Watt							
UGAHL-18D	1	18"	120, 120/208 or 120/240	1360, 1410 or 1360	18 lbs.	\$1648	\$1662
UGAHL-24D	2	24"	120, 120/208 or 120/240	1620, 1620 or 1620	16 lbs.	1680	1694
UGAHL-30D	2	30"	120/208 or 120/240	2370 or 2370	24 lbs.	2090	2109
UGAHL-36D	3	36"	120/208 or 120/240	2880 or 2780	27 lbs.	2181	2200
UGAHL-42D	3	42"	120/208 or 120/240	3180 or 3180	34 lbs.	2564	2583
UGAHL-48D	4	48"	120/208 or 120/240	4290 or 4140	35 lbs.	2647	2673
UGAHL-54D	4	54"	120/208 or 120/240	4740 or 4740	45 lbs.	3027	3053
UGAHL-60D	5	60"	120/208 or 120/240	5700 or 5500	49 lbs.	3114	3154
UGAHL-66D	5	66"	120/208 or 120/240	5700 or 5500	51 lbs.	3479	3519
UGAHL-72D	6	72"	120/208 or 120/240	6360 or 6360	57 lbs.	3602	3642

† Does not include Remote Control Enclosure (RMB).

* Includes either Attached Control or Remote Control Enclosure (RMB) with toggle switch(es) and indicator light(s).

All Ultra-Glo Aluminum Ceramic Infrared Dual with and without Lights models feature:

Models Shipped With: Angle Brackets and Leads (3' conduit whip).

Dimensions With Attached Control Box, Toggle and Indicator Light: 18" - 72"W x 1 1/8" or 2 1/4"D x 2 1/2"H.

Dimensions With Remote Control Enclosure (RMB), Toggle and Indicator Light: 18" - 72"W x 15" or 18"D x 2 1/2"H.

OPTIONS AND REMOTE CONTROL ENCLOSURES (RMB) – PAGE 93

RECOMMENDED MOUNTING HEIGHTS – PAGE 94

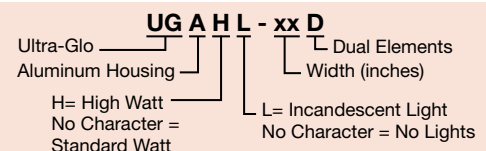

OPTIONS (available at time of purchase only)

Designer Colors, aluminum models 18"-36" – Non-standard colors are non-returnable – Clear Anodized Standard –

COLOR-6	6" Housing for Single UGA and UGAH models, 18"- 36" (color selections below)	per foot	\$32
COLOR-9	9" Housing for Single UGAL and UGAHL models, 18"- 36" (color selections below)	per foot	32
COLOR-15, -18	15" and 18" Housings for Dual UGA, UGAH, UGAL, UGAHL models, 18"- 36" (color selections below)	per foot	46
	RED Warm Red GRAY Gray Granite NAVY Navy Blue COPPER Antique Copper		
	BLACK Black WHITE White Granite GREEN Hunter Green		

Gloss Finishes, aluminum models 18"- 36" – Non-standard colors are non-returnable – Clear Anodized Standard –

GLOSS-6	6" Housing for Single UGA and UGAH models, 18"- 36" (finish selections below)	per foot	\$44
GLOSS-9	9" Housing for Single UGAL and UGAHL models, 18"- 36" (finish selections below)	per foot	44
GLOSS-15, -18	15" and 18" Housings for Dual UGA, UGAH, UGAL, UGAHL models, 18"- 36" (finish selections below)	per foot	59
	RRED Radiant Red GGRAY Glossy Gray BBLACK Bold Black		
	GGOLD Gleaming Gold BBLUE Brilliant Blue		

Designer Colors for Remote Control Enclosures – Non-standard colors are non-returnable – Clear Anodized Standard –

RMB-COLOR	Remote Control Enclosure Housing in Designer Colors		\$46
	RED Warm Red GRAY Gray Granite NAVY Navy Blue COPPER Antique Copper		
	BLACK Black WHITE White Granite GREEN Hunter Green		

Gloss Finishes for Remote Control Enclosures – Non-standard colors are non-returnable – Clear Anodized Standard –

RMB-GLOSS	Remote Control Enclosure Housing in Gloss Finish		\$66
	RRED Radiant Red GGRAY Glossy Gray BBLACK Bold Black		
	GGOLD Gleaming Gold BBLUE Brilliant Blue		

HAL	60 Watt Halogen Bulb in lieu of Standard Display Light	each	\$ 63
LIGHTS ADD'L	Extra Lamps – Installed (max. two per ft. less one, one per ft. is standard) – not available for Dual models	each	32
UGA-NTL-14, -16	Non-Adjustable Tubular Stands – specify 14" or 16" clearance	1 pair	121
UGA-NTL-18, -20	Non-Adjustable Tubular Stands – specify 18" or 20" clearance	1 pair	129
UGA-NTL-22	Non-Adjustable Tubular Stands for 22" clearance	1 pair	140
UGA-NTL-18-D, -20-D	Non-Adjustable Tubular Stands – specify 18" or 20" clearance	2 pair	258
UGA-NTL-22-D, -24-D, -26-D	Non-Adjustable Tubular Stands – specify 22", 24" or 26" clearance	2 pair	279
NTL-PAINT	Designer Colors or Gloss Finishes for Non-Adjustable Tubular Stands to match unit color – Non-Standard colors are non-returnable –	1 pair	45
NTL-PAINT-D	Designer Colors or Gloss Finishes for Non-Adjustable Tubular Stands to match unit color – Non-Standard colors are non-returnable –	2 pair	90

Power Leads – must specify lead length –

HTLEADS5	1'-5' extended Electrical Leads	\$	38
HTLEADS10	6'-10' extended Electrical Leads		76
HTLEADS15	11'-15' extended Electrical Leads		114
HTLEADS20	16'-20' extended Electrical Leads		152

RMB-UGA	Remote Control Enclosure with Toggle Control and Indicator in lieu of attached control box – Designer Colors and Gloss Finishes available – Non-standard colors are non-returnable – Clear Anodized Standard –	No Charge
	RED Warm Red GRAY Gray Granite NAVY Navy Blue COPPER Antique Copper	
	BLACK Black WHITE White Granite GREEN Hunter Green	
	RRED Radiant Red GGRAY Glossy Gray BBLACK Bold Black	
	GGOLD Gleaming Gold BBLUE Brilliant Blue	

RMB-UGA-INF	Remote Control Enclosure with Toggle Switch, Electronic Infinite Control, Relay and Indicator Light in lieu of attached control box – Designer Colors and Gloss Finishes available – Non-standard colors are non-returnable Clear anodized Standard –	\$448
	RED Warm Red GRAY Gray Granite NAVY Navy Blue COPPER Antique Copper	
	BLACK Black WHITE White Granite GREEN Hunter Green	
	RRED Radiant Red GGRAY Glossy Gray BBLACK Bold Black	
	GGOLD Gleaming Gold BBLUE Brilliant Blue	

ACCESSORIES (available for purchase at any time)

Chef LED 120V adjustable bulb – UGA(H)L-xx, UGA(H)L-xxD, models only, pass through usage only – see page 63 for more information –	each	\$129
UGAL models must be at least 14" from surface, UGAHL models must be at least 17" from surface, UGA(H)L-xxD models must be 18"- 22" or higher from surface, all require pass through usage only – bulbs must be rotated down –		
CLED-2700-120 Similar to warm incandescent	CLED-3000-120 Similar to warm Halogen light	CLED-4000-120 Similar to cool Fluorescent light

COLORS AND FINISHES – INSIDE BACK COVER



Chef LED Bulb



RMB-UGA-INF

Strip Heater Recommended Range Above Target* and Spacing Requirements (based on 24" strip heaters, non-flammable surface)

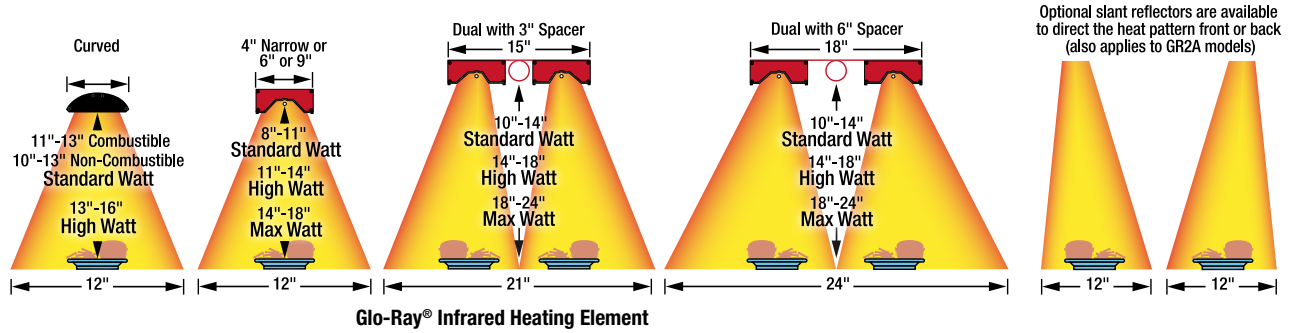

GLO-RAY® INFRARED

Curved Standard Watt (GR5A, GR5AL)

Minimum Combustible: Surface: Install minimum of 1" from back wall, 1" from overshelf and 11" above surface. Minimum non-combustible Surface: 1" from overshelf and 10" above surface (back of wall: no requirement).

Curved High Watt (GR5AH, GR5AHL)

Non-combustible surroundings only. Install 1" from overshelf and minimum of 13" above a non-combustible countertop surface (back of wall: no requirement).

Singles (GRA, GRAL, GRAH, GRAHL, GRN)

Singles Designer (GR2A, GR2AH, GR2AL, GR2AHL)

Combustibles: 13½" high watt or 10" standard watt below, 1" above and 3" to back wall.

Non-combustibles: 1" above, 10" below for high watt with infinite or indicator lamp and 8" below for high watt toggle or standard watt.

Must be installed in a pass-through area. Units with remote switches may be installed against a non-combustible back wall, flush to an overshelf and 8" to a surface below. Maximum 10" setback from the front of an overshelf. Models with cords must be installed 3" below an overshelf and 11" high watt or 10" standard watt over a surface below.

Duals (GRA-D, GRAH-D, GRAL-D, GRAHL-D)

Duals Designer (GR2A-D, GR2AH-D, GR2AL-D, GR2AHL-D)

May not be installed in combustible surroundings.

Non-combustibles: 1" above, 10" below. Must be installed in a pass-through area. Units with remote switches may be installed 3" from a non-combustible back wall, 8" from surface below and flush to an overshelf. Maximum 10" setback from the front of an overshelf.

Singles Max-Watt (GRAM, GRAML, GRNM)

Do not use in combustible surroundings.

Non-combustibles: 1" above, 12" to surface and 3" from back wall. Cord connected: 3" below an overshelf, 12" from surface below. Maximum 10" setback from front of an overshelf.

Duals Max-Watt (GRAM-D, GRAML-D)

May not be installed in combustible surroundings.

Non-combustibles: units may be installed 3" from a non-combustible back wall, 1" below an overshelf, 15" to surface below. Maximum 10" setback from the front of an overshelf.

ULTRA-GLO®

Singles and Duals (UGA, UGA-D, UGAH, UGAH-D, UGAL, UGAL-D, UGAHL, UGAHL-D)

May not be installed in combustible surroundings.

Non-combustibles: 1" above, 17" high watt or 14" standard watt from a surface below and 3" from a back wall.

Dual Mounting Do not mount warmers side by side (dual mounting) with less than a 3" space between units.

GLO-RAY® INFRA-BLACK®

Singles (GRAIH, GRAIHL, GRAIHL-D, GRAIH-D)

May not be installed in combustible surroundings.

Non-combustibles: 1" above and 4" below. Must be installed in a pass-through area. Units with remote switches may be installed 3" from a non-combustible back wall and flush to an overshelf. Maximum 10" setback from the front of an overshelf.

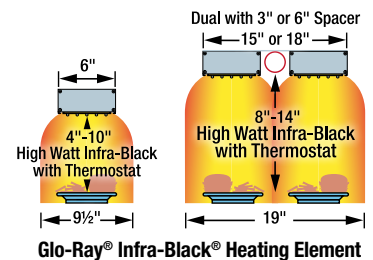
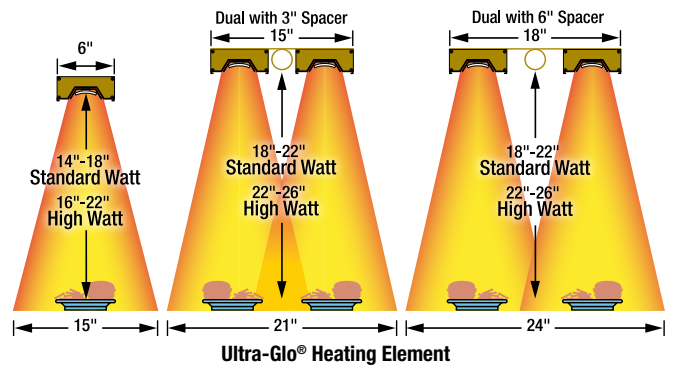
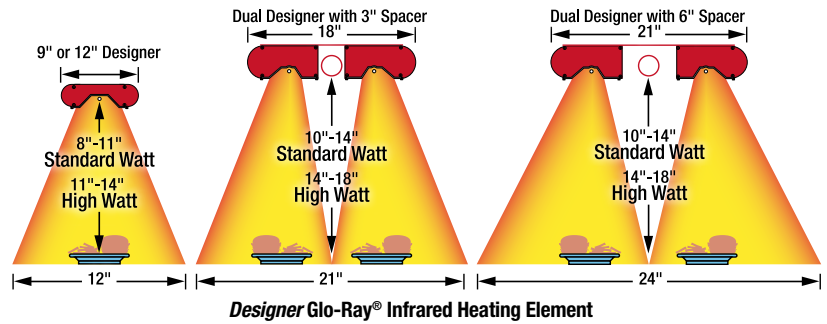

* Recommended single unit application without base heat, based on ideal conditions. Based on a 24" Strip Heater. Individual applications may vary, consult factory. Non-flammable surface only.

Glo-Ray® Mounting Arrangements

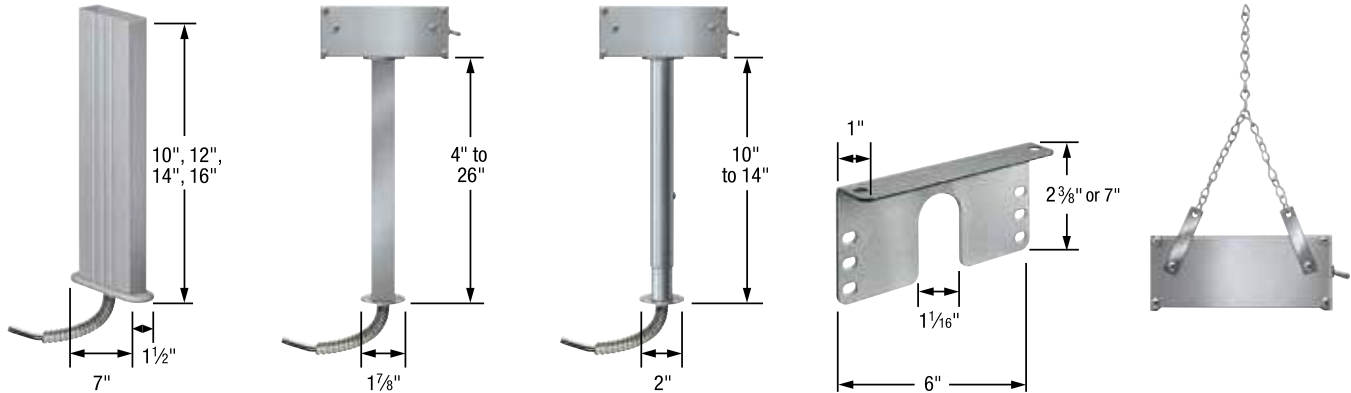

PERMANENT - For hard wired installation

Designer Non-Adjustable Stands

(GR2A series only) Sturdy stands conceal all hook-up wiring. Available in Designer colors.

Non-Adjustable Tubular Stands

Sturdy stands conceal all hook-up wiring. Available in Designer Colors. Duals require two pair. Specify bottom power location.

Adjustable Tubular Stands

Sturdy tubular stands conceal all hook-up wiring. Duals require two pair (not available on Max Watt® or Ultra-Glo® models). Specify bottom power location.

Angle brackets

Special adjustable angle brackets fit 6" or 9" housings for mounting Glo-Ray under a shelf. Provides 1"-2" space or 1"-6" space between Glo-Ray and overshef. Duals require two pair. (standard on Max Watt or Ultra-Glo models).

Chain Suspension

Chains attach to tabs provided with warmers and are available in various lengths to suit the location (not available on Max Watt or Ultra-Glo models).

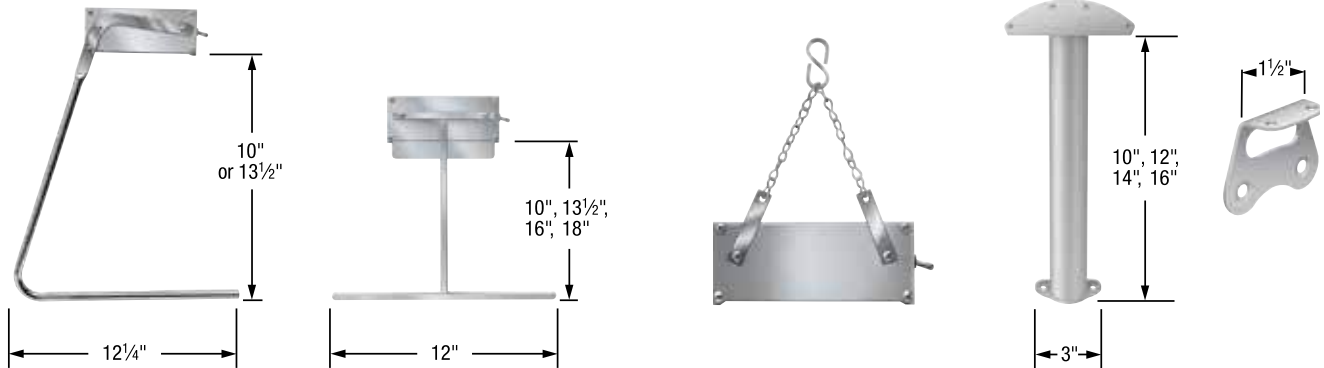

PORTABLE - For cord and plug installation

C-Leg Stands

Attractive chrome plated legs allow easy relocation of the warmer. For models 72" or less in width (not available on Max Watt or Ultra-Glo models). Requires attached cord and plug.

T-Leg Stands

Provide rigid stability and allow for more pass-through area below unit. For models 72" or less in width (not available on Max Watt or Ultra-Glo models). Requires attached cord and plug.

STATIONARY - for cord and plug installation

Chain Hook

Chains attach to tabs provided with warmers. 6" chain with S-Hooks for units with cord and plug only.

GR5A, GR5AH, GR5AL, GR5AHL MOUNTING only

Non-Adjustable Tubular Stands and Angle Brackets

Sturdy stands conceal all hook-up wiring. Specify power location. Standard angle brackets for mounting under a shelf. Provides 1" space between Strip Heater and overshef. End panels and brackets match unit color.

Remote Control Enclosures (RMBs)

1. Find the volt and current (Amp) rating for the Strip Heater(s) the RMB2 will be controlling. This is the total current of all circuits on the warmer(s).
2. If the current rating is under 20 Amps, then select an RMB2-1R, if the current rating is between 20 and 40 Amps, select the RMB2-2R. The RMB2-2R has two 20 Amp outputs.
3. Select the current (Amp) rating of the RMB2 that is just above the total current rating of the warmer(s) it will control. The RMB2 will need to be connected to a branch circuit breaker suitable for its current rating.
4. Select the voltage rating for the RMB2 based on the highest voltage rating of the warmer(s). For example, if the warmer(s) is rated 120/208 volts, select a 208 volt RMB2 control.

- Easy to specify, install and service
- Compatible with most Strip Heaters (GR, GRA, GRAH, GRAIH, GR2A, GR2AH, GR5A, GRN, GRNH and GRAM series)
- Total amperage of light and heat combined cannot exceed max Amp rating of the RMB
- Maximum of 8 Amps total allowed on the light circuit
- Multiple Strip Heaters may be connected to one RMB2 if the combined current draw of the warmers is less than the rating of the RMB2. All warmers will be controlled with same set-point



Need help choosing the correct RMB?
 "Choose Remote Box (RMB)" can be found on:
www.hatcocorp.com
 under "Resources"



RMB2-2R
with two relays



RMB2-1R
with one relay

Strip Heaters

REMOTE CONTROL ENCLOSURES (RMBs)

Model	Description	Voltage	List Price
RMB2			
RMB2-1R – 1 Toggle, 1 Infinite, 1 Relay, 1 Indicator			
	12 Max. Amps	120, 208, 240	\$873
	16 Max. Amps	120, 208, 240	
	20 Max. Amps	120, 208, 240	
RMB2-2R – 1 Toggle, 1 Infinite, 2 Relays, 1 Indicator			
	24 Max. Amps	120, 208, 240	\$995
	32 Max. Amps	120, 208, 240	
	40 Max. Amps	120, 208, 240	

All models feature:

Ship Weight: 6-8 lbs. depending on components.

Dimensions: **RMB2-1R:** 11"W x 4½"D x 5½"H.

RMB2-2R: 14"W x 4½"D x 5½"H.

Cutout Dimensions: **RMB2-1R:** 10⅞" W x 4¾" H.

RMB2-2R: 13⅞" W x 4¾" H.

Remote Control Enclosures (RMBs)

Hatco Remote Control Enclosures (RMBs) are built in accordance with UL standards for toggle or infinite switches, indicator lights and wiring, ready for installation when purchased with Glo-Ray® Strip Heaters. When Remote Control Enclosures are used, no more than one RMB per Strip Heater and no more than one Strip Heater per RMB.

- Built for toggle or infinite switches, indicator lights and wiring
- One RMB per Strip Heater
- Consult RMB configurator for specific details at www.hatcocorp.com, under "Resources"

RMB-7L with toggle switch and infinite control



RMB-16E with infinite controls, toggle switches and optional Designer Warm Red



RMB-14E with infinite controls



RMB-3F with toggle switch and indicator light

RMB-7D with toggle switches and optional Designer Hunter Green



REMOTE CONTROL ENCLOSURES (RMBs)

Model	Description	Voltage	Width	List Price
RMB-3A, -3B, -3C	1 Infinite	120, 208, 240	5½"	\$191
RMB-3D	1 Toggle	120, 208, 240	5½"	169
RMB-3E	2 Toggle	120, 208, 240	5½"	191
RMB-3F, -3G, -3H	1 Toggle, 1 Indicator	120, 208, 240	5½"	191
RMB-7A, -7B, -7C	2 Infinite	120, 208, 240	9"	256
RMB-7D	3 Toggle	120, 208, 240	9"	236
RMB-7E	4 Toggle	120, 208, 240	9"	277
RMB-7F, -7G, -7H	1 Infinite, 1 Indicator	120, 208, 240	9"	229
RMB-7I, -7J, -7K	2 Toggle, 2 Indicator	120, 208, 240	9"	253
RMB-7L, -7M, -7N	1 Toggle, 1 Infinite	120, 208, 240	9"	233
RMB-7O, -7P, -7Q	1 Toggle, 1 Infinite, 1 Indicator	120, 208, 240	9"	256
RMB-7S	2 Toggles, 1 Indicator	120/208, 120/240	9"	233
RMB-14A, -14B, -14C	3 Infinite	120, 208, 240	14"	330
RMB-14D, -14E, -14F	4 Infinite	120, 208, 240	14"	407
RMB-14G	5 Toggle	120, 208, 240	14"	350
RMB-14H	6 Toggle	120, 208, 240	14"	412
RMB-14I, -14J, -14K	3 Toggle, 3 Indicator	120, 208, 240	14"	322
RMB-14L, -14M, -14N	2 Infinite, 2 Indicator	120, 208, 240	14"	333
RMB-14O, -14P, -14Q	2 Toggle, 2 Infinite	120, 208, 240	14"	362
RMB-14R, -14S, -14T	1 Toggle, 1 Infinite w/Relay, 1 Indicator	120, 208, 240	14"	438
RMB-14V, -14W, -14Y	1 Toggle, 2 Infinite	120, 208, 240	14"	317
RMB-14AA, -14AB	Master Toggle, 1 Electronic Infinite w/Relay	120, 208, 240	14"	438
RMB-14AF, -14AG, -14AH	3 Toggle, 2 Indicator	120, 208, 240	14"	300
RMB-14AI, -14AJ, -14AK	1 Toggle, 3 Infinite	120, 208, 240	14"	372
RMB-14AL, -14AM, -14AN	1 Toggle, 2 Infinite, 2 Indicator	120, 208, 240	14"	354
RMB-14AO, -14AP, -14AQ	1 Toggle, 2 Infinite, 3 Indicator	120, 208, 240	14"	375
RMB-14AR, -14AS, -14AT	1 Infinite with Relay, 1 Indicator	120, 208, 240	14"	411
RMB-16B, -16C, -16D	1 Toggle, 4 Infinite	120, 208, 240	16"	439
RMB-16E, -16F, -16G	3 Toggle, 2 Infinite	120, 208, 240	16"	404
RMB-20D, -20E, -20F	3 Toggle, 2 Infinite	120, 208, 240	20"	421
RMB-20G, -20H, -20I	2 Toggle, 4 Infinite	120, 208, 240	20"	502
RMB-20J, -20K, -20L	3 Toggle, 4 Infinite, 4 Indicator	120, 208, 240	20"	594
RMB-20M, -20N, -20P	3 Toggle, 2 Infinite, 2 Indicator	120, 208, 240	20"	463
RMB-20R, -20S, -20T	2 Toggle, 4 Infinite, 4 Indicator	120, 208, 240	20"	575
RMB-20AA, -20AB, -20AC	2 Toggle, 2 Infinite, 2 Indicator	120, 208, 240	20"	439
RMB-20AH, -20AF, -20AG	4 Infinite, 4 Indicator	120, 208, 240	20"	522
RMB-20AN, -20AO, -20AP	4 Toggle, 4 Indicator	120, 208, 240	20"	426

All models feature:

Ship Weight: 2-8 lbs. depending on components.

Max. Allowable Amperage per Switch: Toggle 15.0; Infinite 12.2.

Dimensions (not including switches): 5½", 9", 14", 16" or 20"W x 3"D x 2½"H.

Toggle Switch: Max. 15 Amps
Infinite Switch: Max. 12.2 Amps

Remote Control Enclosures (RMBs): When used, no more than one RMB per Strip Heater and no more than one Strip Heater per RMB.

Need help choosing the correct RMB?
"Choose Remote Box (RMB)" can be found on:
www.hatcocorp.com
under "Resources"

Strip Heaters

OPTIONS (available at time of purchase only)

Designer Colors – Non-standard colors are non-returnable – Clear Anodized Standard –

RMB-COLOR	Remote Control Enclosure Housing in Designer Color						\$46
RED	Warm Red	GRAY	Gray Granite	NAVY	Navy Blue	COPPER	Antique Copper
BLACK	Black	WHITE	White Granite	GREEN	Hunter Green		

Gloss Finishes – Non-standard colors are non-returnable – Clear Anodized Standard –

RMB-GLOSS	Remote Control Enclosure Housing in Gloss Finish				\$66
RRED	Radiant Red	GGRAY	Glossy Gray	BBLACK	Bold Black
GGOLD	Gleaming Gold	BBLUE	Brilliant Blue		

COLORS AND FINISHES – INSIDE BACK COVER

Fry Stations

*Supermarkets & Delis
Restaurants & Cafés • Clubs & Bars*



GRFF in optional Brilliant Blue Gloss finish and **UGFF** in optional Glossy Gray Gloss Finish *pg. 99*



GRFFL with optional 9" display sign holder (sign not included) and *Designer Warm Red* color, and accessory food pan *pg. 99*



GRFHS-PT26 with accessory 8-pleat hardcoated fry box ribbon (scoop not included) *pg. 101*



GRFHS-PTT21 *pg. 101*



GRFSCS-18 with swing-away post mount, cord with plug and accessory food pan *pg. 101*



MPWS-36 shown with optional fry bin insert *pg. 103*

Portable Foodwarmers

Opt for the versatility of Hatco's Glo-Ray® and Ultra-Glo® Portable Foodwarmers. With heat from above, below or both, these foodwarmers offer design flexibility without sacrificing food product quality. Ideal for use next to fry stations, drive-through windows and service areas that require frequent and easy access.

- Portable – ready to plug in and use
- Versatile – available in many sizes, styles and heat sources to fit your needs
- Flexible – both top and bottom heat available
- Available with incandescent bulbs containing special protective coating to guard against food contamination
- Ceramic heating elements provide more distance between the heat source and the holding pan (UGFF series only)
- Toggle switch is standard; infinite switch optional on GRFF series
- All base heat units (GR-B, GRFFB and UGFFB) have a preset automatic thermostat to maintain consistent temperatures



GR-B Heated Base with accessory sheet pan

GRFFB with optional infinite switch and accessory food pans



UGFFL in optional Radiant Red Gloss finish with accessory fry ribbon and food pan



Quick-Ship Model pages 241-247

GLO-RAY® PORTABLE FOODWARMERS

Model	No. of Bulbs	Dimensions W x D x H	Voltage Single Phase	Watts	Plug	Ship Weight	List Price
GR-B	—	12¾" x 22" x 2¼"	120	250	NEMA 5-15P	14 lbs.	\$ 682
GRFF	—	12¾" x 24" x 15⅞"	120	500	NEMA 5-15P	14 lbs.	674
GRFFL	2	12¾" x 24" x 15⅞"	120	620	NEMA 5-15P	14 lbs.	866
GRFFB [§] *	—	12¾" x 24" x 16"-20"	120	750	NEMA 5-15P	29 lbs.	1108
GRFFBL [§]	2	12¾" x 24" x 16"-20"	120	870	NEMA 5-15P	34 lbs.	1274

[§] Standard clearance is 14". Specify 12" or 16" if required.
^{*} Quick-Ship model available in 14" clearance only (18" overall height).

All Portable Models Feature:

Models Shipped with: 6' cord and plug.
 Cord Location: GR-B, GRFFB, GRFFBL: Back, lower middle.
 GRFF, GRFFL: Back, upper middle.

Quick-Ship Model pages 241-247

ULTRA-GLO® PORTABLE FOODWARMERS WITH CERAMIC ELEMENTS

Model	No. of Bulbs	Dimensions W x D x H	Voltage Single Phase	Watts	Plug	Ship Weight	List Price
UGFF	—	12¾" x 22¼" x 18⅞"	120	750	NEMA 5-15P	15 lbs.	\$ 844
UGFFL	2	12¾" x 22¼" x 18⅞"	120	870	NEMA 5-15P	17 lbs.	1041
UGFFB	—	12¾" x 22½" x 22"	120	1000	NEMA 5-15P	25 lbs.	1271
UGFFBL	2	12¾" x 22½" x 22"	120	1120	NEMA 5-15P	34 lbs.	1473

All Ceramic Portable Models Feature:

Models Shipped with: 6' cord and plug.
 Cord Location: UGFF, UGFFL: Back, upper middle.
 UGFFB, UGFFBL: Back, lower middle.

OPTIONS AND ACCESSORIES – PAGE 100

Fry Stations

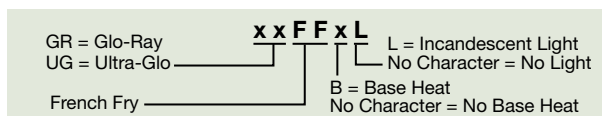



UGFFB with accessory food pan (perforated pan not available)

OPTIONS (available at time of purchase only) (not available on Quick-Ship)

Designer Colors (one color per unit, heated base is not powdercoated, not available for GR-B models)

Non-standard colors are non-returnable – Clear Anodized standard –

RED	Warm Red	\$153
BLACK	Black	153
GRAY	Gray Granite	153
WHITE	White Granite	153
NAVY	Navy Blue	153
GREEN	Hunter Green	153
COPPER	Antique Copper	153

Gloss Finishes (one color per unit, heated base is not painted, not available for GR-B models)

Non-standard colors are non-returnable –

RRED	Radiant Red	\$212
GGOLD	Gleaming Gold	212
GGRAY	Glossy Gray	212
BBLUE	Brilliant Blue	212
BBLACK	Bold Black	212

Clearance (from bottom of Glo-Ray® to top of heated surface) – GRFFB, GRFFBL only – 14" standard –

12"	No Charge
16"	No Charge

SIGN HOLD	Sign Holder for GRFFL model with Back Toggle only (requires 9"W x 5½"H x ¼"D sign, which is not included and adds 3" to height of unit)	\$48
INF	Infinite Control (not available on models GR-B, UGFF, UGFFL, UGFFB or UGFFBL)	47
HAL	60 Watt Halogen Bulb in lieu of standard Display Light	each 63

ACCESSORIES (available for purchase at any time)

5PLTBOX	Five-Pleat Hardcoated French Fry Box Ribbon – 19¼"W x 9¼"D x 2"H	\$234
8PLTBAG	Eight-Pleat Hardcoated French Fry Bag Ribbon – 19¼"W x 9¼"D x 2"H	234

Chef LED 120V adjustable bulb – bulbs must be rotated down – see page 63 for more information – excludes any model without existing bulbs – each 129

CLED-2700-120 Similar to warm Incandescent light **CLED-3000-120** Similar to warm Halogen light **CLED-4000-120** Similar to cool Fluorescent light

FOOD PANS AND TRIVETS – PAGE 240
COLORS AND FINISHES – INSIDE BACK COVER



Accessory Chef LED Bulb

Glo-Ray® Fry Stations

Hatco offers convenient Glo-Ray® Fry Stations that can be placed where they are most needed – next to a fryer! Glo-Ray heat technology offers the ability to keep fried foods at optimum temperatures, ready to serve, without cooking or drying them out.

- Accessory hardcoated fry ribbons stage boxed or bagged products for quick-service areas
- Thermostatically-controlled heated base maintains uniform holding temperatures from below (GRFHS series)
- Portable models including pass-through style (GRFHS series)
- Sectional divider permits holding of multiple products simultaneously (GRFHS series)
- Ceramic elements and slotted holding bin prevent soggy product (GRFHS series)
- Accessory hardcoated fry ribbons absorb more radiant heat than stainless steel, can be up to 15° to 20°F hotter (GRFHS series)
- Fry Station Warmers (GRFSC, GRFS series) feature a built-in top heat source and a swing-away post mount
- GRFSC series available with ceramic heating element, while the GRFS series has a metal sheathed element
- Variety of clearances (GRFS series)
- GRFS series has power toggle switch, cord and plug, plus optional infinite control

GRFHS-21 with optional right-hand cutout for fry basket and accessory fry ribbon (left-hand cutout also available)



GRFHS-PTT21



GRFHS-16



GRFSC-18
Swing-away
post mount

Quick-Ship Model pages 241-247

PORTABLE FRY HOLDING STATIONS

Model	No. of Bulbs	Dimensions (W x D x H)	Voltage (Single Phase)	Watts	Plug	Ship Weight	List Price
GRFHS-16*	2	16 ³ / ₈ " x 22" x 22 ³ / ₁₆ "	120	1090	NEMA 5-15P	51 lbs.	\$3423
✓ GRFHS-21*	2	21 ³ / ₈ " x 28 ¹ / ₂ " x 22 ³ / ₄ "	120	1200	NEMA 5-15P	63 lbs.	3776
GRFHS-22	2	21 ³ / ₈ " x 18" x 17 ³ / ₁₆ "	120	1030	NEMA 5-15P	44 lbs.	3249
GRFHS-26*	2	26 ⁷ / ₁₆ " x 23 ⁷ / ₁₆ " x 22 ³ / ₄ "	120	1200	NEMA 5-15P	66 lbs.	3866
GRFHS-PT16 [▲]	2	21 ³ / ₈ " x 23 ¹ / ₄ " x 24 ⁵ / ₈ "	120	1090	NEMA 5-15P	60 lbs.	3423
GRFHS-PT26 [▲]	2	29 ⁷ / ₈ " x 22 ⁷ / ₁₆ " x 24 ⁵ / ₈ "	120	1440	NEMA 5-15P	64 lbs.	3866
GRFHS-PT26 [■]	2	29 ⁷ / ₈ " x 22 ⁷ / ₁₆ " x 24 ⁵ / ₈ "	120	1440	NEMA 5-15P	64 lbs.	4009
GRFHS-PTT16 [▲]	2	16 ³ / ₄ " x 22 ⁵ / ₈ " x 22 ¹ / ₂ "	120	1300	NEMA 5-15P	65 lbs.	3902
GRFHS-PTT21*	2	22 ³ / ₄ " x 38" x 22 ¹ / ₂ "	120	1740	NEMA 5-15P	100 lbs.	3932

* Add 1³/₄" to width if ordering Scoop Holder.

▲ Scoop Holder standard.

■ Includes a built-in 6" deep heated food holding base (4" is standard on all other models).

All Portable Fry Holding Station Models Feature:

Plug: GRFHS-PTT21 uses NEMA 5-20P in Canada.

Models Shipped with: One slotted holding bin and one sectional divider.

GRFHS-PTT16 also comes with accessory Ten-Pleat Hardcoated Hashbrown Ribbon (PTT16-10BAG).

Cord Location: GRFHS-16, -21, -22, -26, -PT16, -PT26, -PTT16: Back side, lower right corner.

GRFHS-PTT16, -PTT21: Lower right-hand side.



GRFS, GRFSL, GRFSC, GRFSLC with swing-away post mount and cord with plug

FRY STATION WARMERS

Model	No. of Bulbs	Dimensions (W x D x H)	Voltage (Single Phase)	Watts	Plug	Ship Weight	List Price
GRFSC-18 [□]	—	6" x 18" x 19 ¹ / ₄ "-22 ¹ / ₂ "	120	750	NEMA 5-15P	11 lbs.	\$722
GRFSL-18 [□]	2	9" x 18" x 19 ¹ / ₄ "-22 ¹ / ₂ "	120	870	NEMA 5-15P	13 lbs.	872
GRFSCR-18 [†]	—	6" x 18" x 19 ¹ / ₄ "-22 ¹ / ₂ "	120	750	—	12 lbs.	723
GRFSLR-18 [†]	2	9" x 18" x 19 ¹ / ₄ "-22 ¹ / ₂ "	120	870	—	13 lbs.	872
GRFS-24 [□]	—	6" x 24" x 12 ¹ / ₂ "-15 ¹ / ₂ "	120	500	NEMA 5-15P	10 lbs.	585
GRFSL-24 [□]	2	9" x 24" x 12 ¹ / ₂ "-15 ¹ / ₂ "	120	620	NEMA 5-15P	13 lbs.	745
GRFSR-24 [†]	—	6" x 24" x 12 ¹ / ₂ "-15 ¹ / ₂ "	120	500	—	10 lbs.	585
GRFSLR-24 [†]	2	9" x 24" x 12 ¹ / ₂ "-15 ¹ / ₂ "	120	620	—	13 lbs.	745

□ Specify clearance of 16³/₄", 18" (standard) or 20" when ordering.

† Fry Station Warmer without cord and plug, UL recognized. Supply wires through mounting post.

□ Specify clearance of 10", 11", 12" or 13" (standard) when ordering.

All Fry Station Warmer Models Feature:

Toggle Switch Location: Ceramic Heating Element Models: Back of unit.

Metal Sheathed Heating Element Models: Front of unit.

Cord Location GRFSC-18, GRFSL-18, GRFS-24 and GRFSL-24: Back, upper middle.

OPTIONS AND ACCESSORIES – PAGE 102

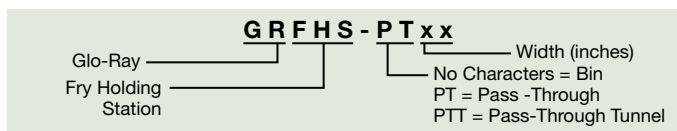

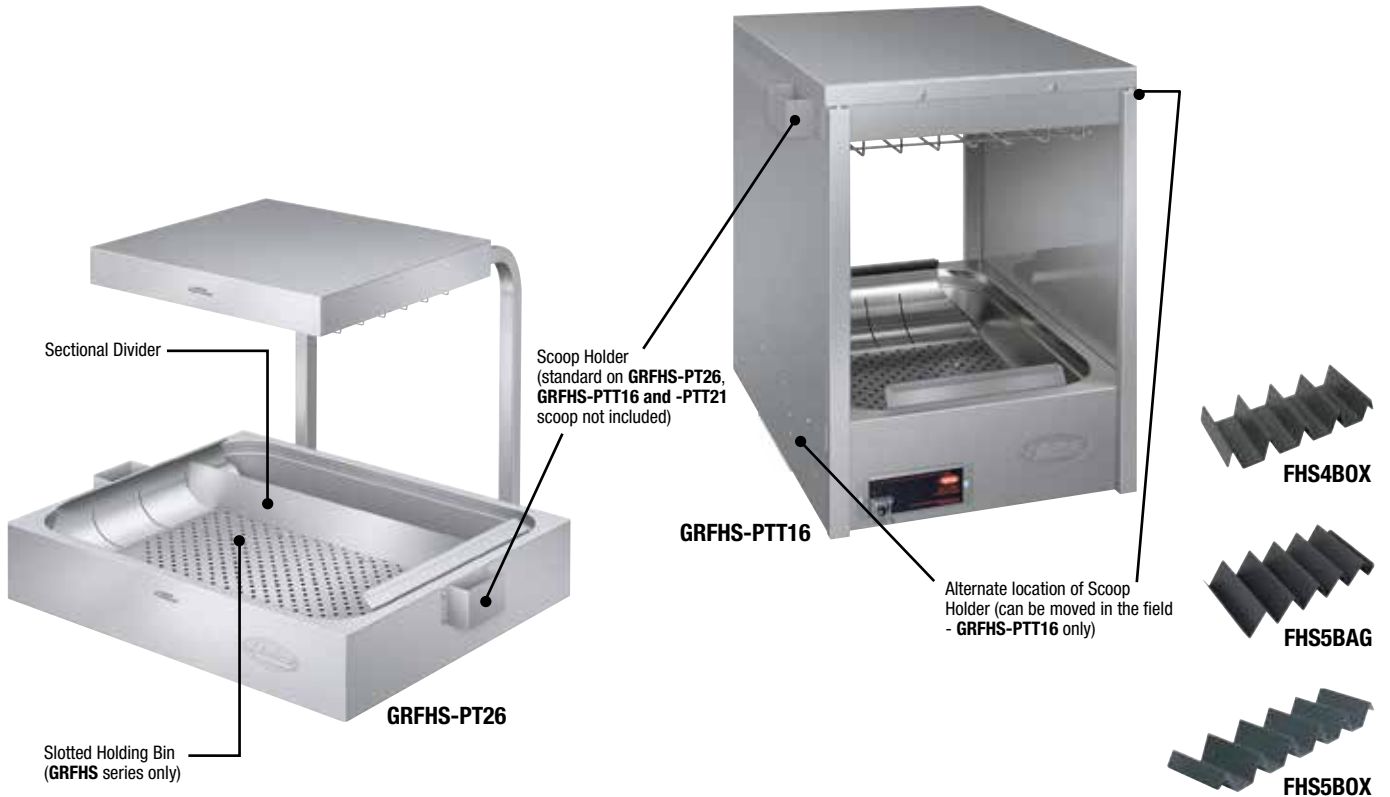

OPTIONS (available at time of purchase only) (not available on Quick-Ship)

FHS-CUT	Right- or Left-Hand Cutout for Fry Basket – must specify side at time of order Adds 1 1/16" to width of unit (GRFHS-16, -21, -26 models only)	No Charge
INF	Infinite Control (metal sheathed GRFS models only)	\$48
HAL	60 Watt Halogen Bulb in lieu of standard Display Light	each 63

ACCESSORIES (available for purchase at any time)

FHS4BOX	Four-Pleat Hardcoated Fry Box Ribbon (All models) – 10 3/4"W x 5"D x 1 3/4"H	\$ 90
FHS5BAG	Five-Pleat Hardcoated Fry Bag Ribbon (All models) – 11 1/4"W x 5"D x 1 7/8"H	90
FHS5BOX	Five-Pleat Hardcoated Fry Box Ribbon (GRFHS-21, -PT26, -PTT16, -PTT21) – 17 1/2"W x 5"D x 1 7/8"H	146
FHS6BAG	Six-Pleat Hardcoated Fry Bag Ribbon (GRFHS-21, -PT26, -PTT16, -PTT21) – 13 3/4"W x 5"D x 2"H	98
FHS6BB	Six-Pleat Hardcoated Fry Box/Bag Ribbon (GRFHS-21, -PT26, -PTT16, -PTT21) – 17 1/4"W x 5"D x 1 3/4"H	146
FHS7BAG	Seven-Pleat Hardcoated Fry Bag Ribbon (GRFHS-21, -PT26, -PTT21) – 17 7/8"W x 5"D x 1 7/8"H	146
PTT16-10BAG	Ten-Pleat Hardcoated Hashbrown Ribbon – (GRFHS-PT26, -PTT21) – 15"W x 3 7/8"D x 1 3/4"H Standard on GRFHS-PTT16	137
5BH	5" Side-by-Side Bag Holder (GRFHS-21)	60
FHS-SH	Scoop Holder – adds 1 1/4" to width of unit – One standard on GRFHS-PT26, -PTT16 & -PTT21 models, not available for GRFHS-22 (Scoop Holder on GRFHS-PTT16 can be moved to two alternate locations in the field)	60
FHSDIV1	Sectional Divider – 16" W x 3 1/4" H – GRFHS-16, -26 and -PTT16 models	35

Chef LED 120V adjustable bulb – bulbs must be rotated down – see page 63 for more information – each 129

CLED-2700-120	Similar to warm Incandescent light	CLED-3000-120	Similar to warm Halogen light
CLED-4000-120	Similar to cool Fluorescent light		

FOOD PANS AND TRIVETS – PAGE 240



Accessory Chef LED Bulb



FHS-SH

Multi-Product Warming Stations

Hatco's redesigned Multi-Product Warming Station safely holds hot fried foods at optimum serving temperatures in kitchen work areas. The unit is designed for maximum durability and performance with minimum maintenance.

- New removable left/right side panel
- New wider, deeper side openings
- Easy access to food product
- Coated shatter-resistant incandescent lights enhance brilliant product display while safeguarding food from bulb breakage
- Six overhead ceramic heating elements are adjusted by two separate electronic infinite controls – one for the rear elements and one for the front elements
- Thermostatically controlled base heat assures safe serving temperatures
- All stainless steel construction
- Master On/Off rocker switch

ENDLESS POSSIBILITIES OF CONFIGURATION

Incremental spacing between portable dividers is 5 1/8"



MPWS-36 with accessory angled risers, fry pan and trivet (plastic pans not available)



Shown with accessory fry bin insert and standard detachable side panel on right side



Shown with optional fry pans, and accessory angled riser and scoop holder (plastic pans not available)



Shown with optional fry pans, accessory fry ribbon on angled riser and accessory scoop holder



Shown with accessory fry ribbons on angled risers, fry pan and scoop holder (plastic pans not available)

MULTI-PRODUCT WARMING STATIONS

Model	No. of Bulbs	Dimensions W x D x H	Watts		Plug	Ship Weight	List Price
			120/208V	120/240V			
MPWS-36	4	37 1/16" x 24 1/16" x 32 3/4"	2773	2755	NEMA L14-20P	152 lbs.	\$5397
MPWS-45	4	45 1/16" x 24 1/16" x 32 3/4"	2799	2780	NEMA L14-20P	170 lbs.	6036

All Multi-Product Warming Station Models Feature:
Models Shipped with: 4" adjustable legs.
Cord Location: Back side, upper left corner.

OPTION CAPACITIES

Model	Fry Pan with Trivet	Angled Risers
MPWS-36	1	3
	2	1
	0	5
MPWS-45	1	4
	2	2
	0	6

OPTIONS (available at time of purchase only)

HAL	60 Watt Halogen Bulb in lieu of standard Display Light	each \$63
------------	--	-----------

ACCESSORIES (available for purchase at any time)

FHS4BOX	Four-Pleat Hardcoated Fry Box Ribbon – 10 3/4"W x 5"D x 1 1/4"H	\$ 90
FHS5BAG	Five-Pleat Hardcoated Fry Bag Ribbon – 11 1/4"W x 5"D x 1 1/8"H	90
5BH	5" Side-by-Side Bag Holder	60
FHS-SH	Scoop Holder	60
MPWS-RISER	Angled Riser	120
MPWS-PT	Fry Pan and Trivet	525
MPWS36BIN	Full Fry Bin Insert for MPWS-36 unit only (includes Drip Tray, Perforated Insert and 3 Dividers)	each 498
MPWS45BIN	Full Fry Bin Insert for MPWS-45 unit only (includes Drip Tray, Perforated Insert and 4 Dividers)	each 533

Chef LED 120V adjustable bulb – bulbs must be rotated down – see page 63 for more information – each 129

CLED-2700-120 Similar to warm Incandescent light **CLED-3000-120** Similar to warm Halogen light

CLED-4000-120 Similar to cool Fluorescent light

FOOD PANS AND TRIVETS – PAGE 240

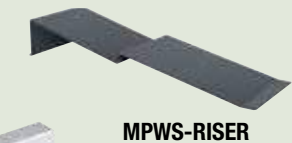
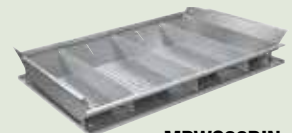
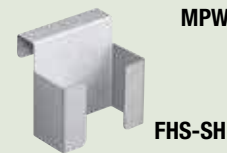
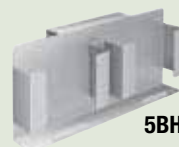

Fry Stations

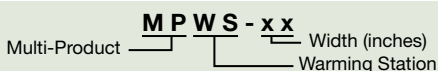

Carving Stations

*Supermarkets & Delis
Restaurants & Cafés • Clubs & Bars*



DCSB400-1CM models above two **HGSM-1P** models *pg. 105*



DCSB400-R24-1 with optional Bermuda Sand base and optional Bright Brass post and shade *pg. 105*



DCSB400-R24-1 with optional Gray Granite base and Standard Bright Nickel post and shade. Shown with **GR2S-36** *pg. 105*



DCSB400-R24-1 with optional Gray Granite base and Standard Bright Nickel post and shade *pg. 105*



GRCSCS-24 with accessory left-hand sneeze guard, drip pan and cutting board *pg. 106*



ACCESSORIES (CSCL-BOARD shown) *pg. 106*

Decorative Carving Stations

Decorative Carving Stations provide proper food serving temperatures by combining the Hatco Decorative Heat Lamp with a simulated stone Heated Base to create an attractive carving display. Perfect for chef stations in restaurants, hotels, country clubs, casinos and for any catered event.

- Available as post mount, permanent counter mount or freestanding with a rounded or rectangular heated simulated stone base (DCS400-1, -1CM do not have bases)
- The patented telescoping heated Decorative Lamp has a 30° shade pivot
- Heated bases are made of foodsafe materials and controlled by an adjustable thermostat and power switch
- Units come with matching cutting board (except DCS400-1, -1CM), keeping juices contained and tablecloths clean
- DCS400-1 has a 40 lb. weighted base, perfect for buffet use
- Sneeze guard is removable for easy cleaning (DCSB400-R24-1, -2420-1, -3624-2 models only)
- Models with simulated stone are Swanstone®

DCS400-1CM
with optional Bright Brass post and optional Bermuda Sand trim ring



DCSB400-R24-1
with optional Bermuda Sand base and Standard Bright Nickel post and shade



DCSB400-3624-2
with Standard Night Sky base and Standard Bright Nickel posts and shades



DECORATIVE CARVING STATIONS

Model	No. of Lamps	Width	Heated Base Surface Area	Voltage	Watts	Plug	Ship Weight	List Price
DCS400-1	1	8"	—	Single Phase	120	NEMA 5-15P	32 lbs.	\$1686
DCS400-1CM	1	6 1/8"	—		120	NEMA 5-15P	18 lbs.	1651
DCSB400-R24-1	1	26"	24" diameter		120	NEMA 5-15P	75 lbs.	4209
DCSB400-2420-1	1	24"	24"W x 20"D		120	NEMA 5-15P	82 lbs.	4208
DCSB400-3624-2	2	36"	36"W x 24"D		1300	NEMA 5-15P	128 lbs.	6087

All Decorative Carving Station Models Feature:

- Models Ship with: DCS400-1, -1CM: One clear coated bulb. DCS400-1 includes black base.
- DCSB400-R24-1, -2420-1: One clear coated bulb, base heat, glass sneeze guard and cutting board.
- DCSB400-3624-2: Two clear coated bulbs, base heat, glass sneeze guard and cutting board.
- Telescoping Clearance: DCS400-1, -1CM: (bottom of shade to counter) 16"-28".
- DCSB400-R24-1, -2420-1, -3624-2: (bottom of shade to top of cutting board) 14"-26".
- Cord Location: DCS400-1: Base of unit, server side center. DCS400-1CM: Under counter.
- DCSB400-R24-1, -2420-1, -3624-2: Base of unit, server side on left.

DCS400-1
with optional Bright Brass post and shade and black base



OPTIONS (available at time of purchase only)

Shade and post(s) in Plated Finish, no additional charge – Non-Standard colors are non-returnable – Bright Nickel Standard –

BBRASS	Bright Brass	No Charge
BCOPPER	Bright Copper	No Charge
ABRASS	Antique Brass	No Charge
ABRONZE	Antique Bronze	No Charge

Base and Cutting Board (except DCS400-1, -1CM) in simulated stone, no additional charge – Non-Standard colors are non-returnable – Night Sky Standard –

GGRAN	Gray Granite	No Charge
BSAND	Bermuda Sand	No Charge

Trim Ring (DCS400-1CM only) in simulated stone, no additional charge – Non-Standard colors are non-returnable – Night Sky Standard –

GGRAN	Gray Granite	No Charge
BSAND	Bermuda Sand	No Charge

ACCESSORIES (available for purchase at any time)

RED-CTD-120	120 Volt, 250 Watt, Red Bulb, Coated	each \$47
-------------	--------------------------------------	-----------

COLORS AND FINISHES – INSIDE BACK COVER



Close-up of **Trim Ring** in Standard Night Sky (Unit shown in Optional Plated Antique Bronze finish)

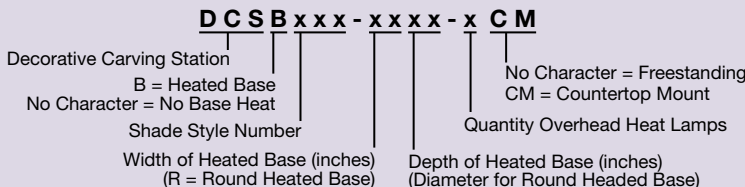

Glo-Ray® Carving Stations

An excellent addition to extend food holding times during serving periods is the Glo-Ray® Carving Station. Create a complete serving station for buffets by adding it to Hatco's Flav-R-Savor® Holding Cabinet.

- Overhead ceramic heating elements project high intensity radiant heat over entire target area
- Adjustable clearance of 17½" to 23½"
- Portable – includes a 6' cord and plug
- Shatter-resistant incandescent lights illuminate holding area
- Drip pan and cutting board available
- GRCSCLH has base heat



GRCSCL-24 with accessory left-hand sneeze guard, drip pan and cutting board



GRCSCLH-24 with accessory left-hand sneeze guard, drip pan and cutting board



GRCSCLH-24 controls

CARVING STATIONS

Model	No. of Bulbs	Dimensions W* x D x H	Voltage Single Phase	Watts	Plug	Ship Weight	List Price
GRCSCL-24	4	26" x 28" x 22½"-28½"	120	990	NEMA 5-15P	57 lbs.	\$3960
GRCSCLH-24	4	26" x 28" x 22½"-28½"	120	1290	NEMA 5-15P	57 lbs.	4472

* Width includes accessory left-hand sneeze guard.

All Carving Station Models Feature:

Models Shipped with: Right-hand sneeze guard.
Cord Location: Back side on base.

OPTIONS (available at time of purchase only)

HAL	60 Watt Halogen Bulb in lieu of Standard Display Light	each \$63
------------	--	-----------

ACCESSORIES (available for purchase at any time)

CSCLB/PACC	Left-Hand Sneeze Guard Kit (3 lbs.)	\$289
CSCL-PAN	Stainless Steel custom Drip Pan – 20" x 26¾" x 1" – (9 lbs.)	298
CSCL-BOARD	Approved foodsafe Cutting Board – 18" x 24" x 1¾" – (19 lbs.)	281

Chef LED 120V adjustable bulb – bulbs must be rotated down – see page 63 for more information – each 129

CLED-2700-120 Similar to warm Incandescent light **CLED-3000-120** Similar to warm Halogen light **CLED-4000-120** Similar to cool Fluorescent light



CSCLB/PACC

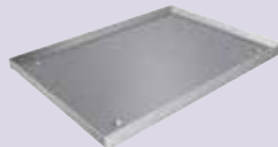

CSCL-PAN



CSCL-BOARD



Accessory Chef LED Bulb

GRCSCLH - x



Portables

*Cafeterias • Buffets • Convenience Stores
Supermarkets & Delis • Restaurants & Cafés
Clubs & Bars • Catering • Concessions*



GRSSR with optional 3" or 5" risers in standard Night Sky simulated stone *pg. 110*



GRSSR20-DL77516 with standard Night Sky simulated stone heated base *pg. 110*



GRS-72-I with Accessory food pans *pg. 112*



GR2S-30 with optional *Designer* Hunter Green inset panels and Accessory pizza pans *pg. 114*



GRSS-3618 in optional Bermuda Sand simulated stone *pg. 115*



HBG-2418 in optional White Glass *pg. 116*



GRHW-1SGDS (signage not included) *pg. 118*



GRHW-1SG *pg. 118*



GRBW-72 Two units side by side *pg. 119*



Portable Lamp Warmer

The portable, powdercoated Hatco Lamp Warmer has a specially-designed stand that keeps food holding pans above the countertop and provides insulation to extend holding times.

- Features two vented lamps with heavy-duty sockets
- Adjustable stand from 24³/₈" to 30³/₈" in height
- Cord and plug with in-line power switch
- Gray Granite is Standard color with optional *Designer Colors* available: Warm Red, Black, Gray Granite, White Granite, Navy Blue, Hunter Green, Antique Copper (non-standard colors are non-returnable)
- Holds food pans, wire trivets and fry ribbons



LW-2 in optional *Designer Black* with Accessory food pans

Quick-Ship Model pages 241-247

PORTABLE LAMP WARMER

Model*	No. of Bulbs	Dimensions W x D x H	Voltage Single Phase	Watts	Plug	Ship Weight	List Price
✓ LW-2	2	12 ³ / ₈ " x 21 ⁵ / ₈ " x 24 ³ / ₈ "-30 ³ / ₈ "	120	500	NEMA 5-15P	18 lbs.	\$816

* Quick-Ship model is Gray Granite.

All Portable Lamp Warmer models feature:

Bulbs: Two 250 Watt *uncoated* clear bulbs.

Cord Location: 6' cord and plug, located back of adjustable stand near top.

Lamp Distance: 10¹/₂"-16¹/₂" space from bottom of lamp to top of base.

OPTIONS (available at time of purchase only – not available on Quick-Ship)

Designer Colors – Non-standard colors are non-returnable – Gray Granite standard –

RED	Warm Red	No Charge
BLACK	Black	No Charge
WHITE	White Granite	No Charge
NAVY	Navy Blue	No Charge
GREEN	Hunter Green	No Charge
COPPER	Antique Copper	No Charge

ACCESSORIES (available for purchase at any time)

WHITE-CTD-120	250 Watt Clear Bulb, Coated (unit accommodates two bulbs)	each \$38
RED-UCTD-120	250 Watt Red Bulb, Uncoated (unit accommodates two bulbs)	each 37
RED-CTD-120	250 Watt Red Bulb, Coated (unit accommodates two bulbs)	each 47

FRY RIBBONS – PAGE 102

FOOD PANS AND TRIVETS – PAGE 240

COLORS AND FINISHES – INSIDE BACK COVER

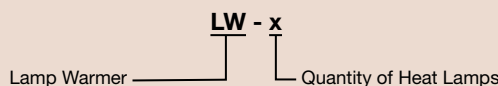

Glo-Ray® Round Portable Heated Shelves

The contemporary-styled Round Heated Shelves keeps hot food at serving temperatures. Ideal when used for wrapped product or for use behind a sneeze guard with unwrapped food like pizza, biscuits, muffins and cookies.

- Unit is designed for countertop or built-in use – see cutout dimensions shown below
- Uniform heat distribution with blanket-type element
- Thermostatically-controlled heated base
- Available in three sizes to hold standard 15", 17" or 19" diameter pans
- Optional stainless steel trim



GRSR-17 in optional *Designer* Navy Blue with Accessory food pan

GRSR-19 in optional *Designer* Hunter Green with Accessory pizza pan

GLO-RAY ROUND PORTABLE HEATED SHELVES

Model	Dimensions Diameter x H	Max. Pan Size Diameter	Voltage Single Phase	Watts	Plug	Ship Weight	List Price
GRSR-15	16¾" x 3⅞"	15"	120	250	NEMA 5-15P	12 lbs.	\$1006
GRSR-17	18¾" x 3⅞"	17"	120	325	NEMA 5-15P	14 lbs.	1059
GRSR-19	20¾" x 3⅞"	19"	120	400	NEMA 5-15P	17 lbs.	1122

All Glo-Ray Round Portable Heated Shelf models feature:
Cord Location: 6' cord and plug, located underneath.

OPTIONS (available at time of purchase only)

Designer Colors – Non-standard colors are non-returnable – Black standard –

RED	Warm Red	No Charge
GRAY	Gray Granite	No Charge
WHITE	White Granite	No Charge
NAVY	Navy Blue	No Charge
GREEN	Hunter Green	No Charge
COPPER	Antique Copper	No Charge
SS SIDE	Stainless Steel Side	No Charge

FOOD PANS AND TRIVETS – PAGE 240
COLORS AND FINISHES – INSIDE BACK COVER

PORTABLE ROUND HEATED SHELVES COUNTERTOP CUTOUT DIMENSIONS (For Built-in Applications)

Model	Minimum Diameter	Maximum Diameter	Below Counter
GRSR-15	16⅞"	16¼"	5⅞"
GRSR-17	18⅞"	18¼"	5⅞"
GRSR-19	20⅞"	20¼"	5⅞"

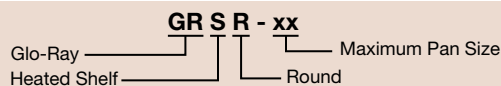

Glo-Ray® Simulated Stone Round Portable Heated Shelves

Hatco's Glo-Ray® Simulated Stone Round Portable Heated Shelves are made of foodsafe materials and are offered in three colors. These unique warmers will safely hold food hot while blending in with your décor and are ideal for buffet lines or as hors d'oeuvre displays.

- Blanket-type element creates uniform heat across the entire simulated stone surface
- Features a lighted rocker switch and thermostatically-controlled heated base to help hold your food hot and delicious
- Optional 3" or 5" risers available in stainless steel (Standard) or *Designer Colors*
- Models with simulated stone are Swanstone®

GRSSR-16 in Standard Night Sky simulated stone with optional 3" riser in optional *Designer Gray Granite*



GRSSR-18 in Standard Night Sky simulated stone with optional 5" riser in optional *Designer Warm Red*



GRSSR-20 in Standard Night Sky simulated stone



GRSSR20-DL77516 in Standard Night Sky simulated stone with Standard *Designer Black* Base and Lamp



GLO-RAY SIMULATED STONE ROUND PORTABLE HEATED SHELVES

Model	Dimensions Dia. x H	Voltage		Watts	Amps	Plug	Ship Weight	List Price
		Single Phase						
GRSSR-16	16" x 2 ⁵ / ₈ "	120		250	2.1	NEMA 5-15P	14 lbs.	\$1294
GRSSR-18	18" x 2 ⁵ / ₈ "	120		325	2.7	NEMA 5-15P	16 lbs.	1380
GRSSR-20	20" x 2 ⁵ / ₈ "	120		400	3.3	NEMA 5-15P	18 lbs.	1466

All Glo-Ray Simulated Stone Round Portable Heated Shelf models feature:

Temperature Range: 100°-200°F.

Cord Location: 6' cord and plug, located on back side on base.

GLO-RAY SIMULATED STONE ROUND PORTABLE HEATED SHELVES with DECORATIVE LAMP

Model	Dimensions W x D x H	Voltage		Watts	Amps	Plug	Ship Weight	List Price
		Single Phase						
GRSSR16-DL77516	16" x 20 ¹ / ₂ " x 36"	120		500	4.2	NEMA 5-15P	27 lbs.	\$1914
GRSSR18-DL77516	18" x 21 ¹ / ₂ " x 36"	120		575	4.8	NEMA 5-15P	30 lbs.	2002
GRSSR20-DL77516	20" x 22 ¹ / ₂ " x 36"	120		650	5.4	NEMA 5-15P	32 lbs.	2090

All Glo-Ray Simulated Stone Round Portable Heated Shelf models with Decorative Lamp feature:

Bulb: One, 250 Watt clear bulb, uncoated.

Temperature Range: 100°-200°F.

Cord Location: 6' cord and plug, located on back side on base.

Lamp Distance: 16¹/₄" space from bottom of shade to base.

OPTIONS AND ACCESSORIES – PAGE 111

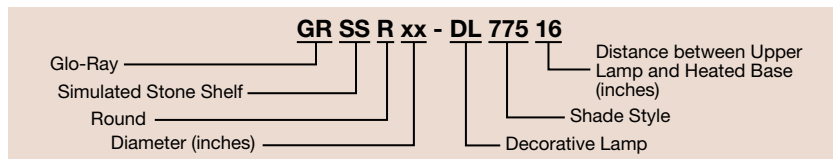
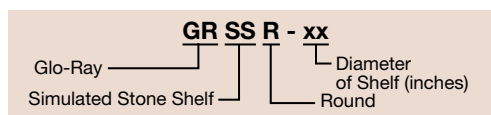



Two GRSSR20-DL77516 units in optional Gray Granite simulated stone and Standard Designer Black Base and Shade

OPTIONS (available at time of purchase only)

120H-CTD-W	120V, 375W Clear Coated Bulb in lieu of 120V uncoated white bulb (High Watt models only)	\$61
120H-UCTD-W	120V, 375W Clear Uncoated Bulb in lieu of 120V uncoated white bulb (High Watt models only)	47

Designer Color Base (and Lamp for GRSSRxx-DL77516 models) – Non-standard colors are non-returnable – Black standard –

RED	Warm Red	No Charge
GRAY	Gray Granite	No Charge
WHITE	White Granite	No Charge
NAVY	Navy Blue	No Charge
GREEN	Hunter Green	No Charge
COPPER	Antique Copper	No Charge

Simulated stone color – Non-standard colors are non-returnable – Night Sky standard –

SS-GGRAN	Gray Granite	No Charge
SS-BSAND	Bermuda Sand	No Charge

3" Risers (not available on the GRSSRxx-DL77516 models) – Available in Designer Colors– Non-standard colors are non-returnable – Stainless Steel standard –

3RISER16	GRSSR-16	\$65
3RISER18	GRSSR-18	65
3RISER20	GRSSR-20	65

5" Risers (not available on the GRSSRxx-DL77516 models) – Available in Designer Colors – Non-standard colors are non-returnable – Stainless Steel standard –

5RISER16	GRSSR-16	\$84
5RISER18	GRSSR-18	84
5RISER20	GRSSR-20	84

ACCESSORIES (available for purchase at any time)

WHITE-CTD-120	250 Watt Clear Bulb, Coated (GRSSRxx-DL77516 models accommodate one bulb)	each \$38
RED-UCTD-120	250 Watt Red Bulb, Uncoated (GRSSRxx-DL77516 models accommodate one bulb)	each 37
RED-CTD-120	250 Watt Red Bulb, Coated (GRSSRxx-DL77516 models accommodate one bulb)	each 47

COLORS AND FINISHES – INSIDE BACK COVER



Glo-Ray® Portable Heated Shelves

Whether you need a heated workspace or extra base heat in a pass-through or buffet area, Hatco's full line of Glo-Ray® Heated Shelf options can help you. Using a blanket heating element for an even temperature, the thermostatically-controlled base safely extends the holding time of your food.

Flexibility, style and quality mark these workhorses of the buffet. Available in a variety of widths and depths to meet your specific needs.

- Uniform heat distribution with a blanket-type element
- Built-in adjustable thermostat controls surface temperature
- Extruded aluminum base with stainless steel top – optional Hardcoat Aluminum surface
- Accessory 4" legs (Standard on 36" and wider models)
- Accessory slant leg kit and pan rail

- Model widths from 18" to 72"
- Model depths: 6", 7³/₄", 9³/₄", 12", 13³/₄", 15¹/₂", 15³/₄", 17¹/₂", 19¹/₂", 21¹/₂", 23¹/₂", 25¹/₂"
- Optional Designer Colors: Warm Red, Black, Gray Granite, White Granite, Navy Blue, Hunter Green, Antique Copper. Non-standard colors are non-returnable
- New optional Thermostat Guard available (GRS models only)



GRS-30-I in optional Designer Warm Red with Accessory pan rail and food pans

Quick-Ship Model pages 241-247

GLO-RAY PORTABLE HEATED SHELVES

Model	Dimensions W x H	Voltage Single Phase	Watts	Plugs	Ship Weight	List Price
19 1/2" depth I – Standard 19 1/2" depth accommodates 12" x 20" steam table pans						
GRS-18-I	18" x 2 3/8"	120	250	NEMA 5-15P	16 lbs.	\$ 979
GRS-24-I	24" x 2 3/8"	120	350	NEMA 5-15P	20 lbs.	1071
GRS-30-I	30" x 2 3/8"	120	450	NEMA 5-15P	25 lbs.	1154
GRS-36-I	36" x 5 3/8"	120	550	NEMA 5-15P	28 lbs.	1235
GRS-42-I	42" x 5 3/8"	120	600	NEMA 5-15P	32 lbs.	1395
GRS-48-I	48" x 5 3/8"	120	700	NEMA 5-15P	36 lbs.	1454
GRS-54-I	54" x 5 3/8"	120	800	NEMA 5-15P	42 lbs.	1566
GRS-60-I	60" x 5 3/8"	120	900	NEMA 5-15P	44 lbs.	1623
GRS-66-I	66" x 5 3/8"	120	1000	NEMA 5-15P	50 lbs.	1686
GRS-72-I	72" x 5 3/8"	120	1100	NEMA 5-15P	56 lbs.	1826
6" depth A						
GRS-18-A	18" x 2 3/8"	120	100	NEMA 5-15P	7 lbs.	\$ 729
GRS-24-A	24" x 2 3/8"	120	125	NEMA 5-15P	11 lbs.	753
GRS-30-A	30" x 2 3/8"	120	150	NEMA 5-15P	9 lbs.	785
GRS-36-A	36" x 5 3/8"	120	175	NEMA 5-15P	11 lbs.	812
GRS-42-A	42" x 5 3/8"	120	225	NEMA 5-15P	15 lbs.	899
GRS-48-A	48" x 5 3/8"	120	250	NEMA 5-15P	16 lbs.	925
GRS-54-A	54" x 5 3/8"	120	275	NEMA 5-15P	17 lbs.	949
GRS-60-A	60" x 5 3/8"	120	300	NEMA 5-15P	18 lbs.	969
GRS-66-A	66" x 5 3/8"	120	325	NEMA 5-15P	20 lbs.	1041
GRS-72-A	72" x 5 3/8"	120	350	NEMA 5-15P	22 lbs.	1057
7 3/4" depth B						
GRS-18-B	18" x 2 3/8"	120	100	NEMA 5-15P	10 lbs.	\$ 754
GRS-24-B	24" x 2 3/8"	120	125	NEMA 5-15P	10 lbs.	785
GRS-30-B	30" x 2 3/8"	120	150	NEMA 5-15P	12 lbs.	826
GRS-36-B	36" x 5 3/8"	120	175	NEMA 5-15P	14 lbs.	863
GRS-42-B	42" x 5 3/8"	120	225	NEMA 5-15P	19 lbs.	949
GRS-48-B	48" x 5 3/8"	120	250	NEMA 5-15P	19 lbs.	993
GRS-54-B	54" x 5 3/8"	120	275	NEMA 5-15P	20 lbs.	1012
GRS-60-B	60" x 5 3/8"	120	300	NEMA 5-15P	21 lbs.	1062
GRS-66-B	66" x 5 3/8"	120	325	NEMA 5-15P	26 lbs.	1078
GRS-72-B	72" x 5 3/8"	120	350	NEMA 5-15P	24 lbs.	1128

All Glo-Ray Portable Heated Shelf models feature:

- Pan Capacity (12" x 20"): GRS-18-I, -24-I = 1-pan
- GRS-30-I, -36-I = 2-pan
- GRS-42-I, -48-I = 3-pan
- GRS-54-I, -60-I = 4-pan
- GRS-66-I, -72-I = 5-pan

Cord Location: 6' cord and plug, located, center of side with switch.

OPTIONS AND ACCESSORIES – PAGE 114

GLO-RAY PORTABLE HEATED SHELVES continued...

Model	Dimensions W x H	Voltage Single Phase	Watts	Plugs	Ship Weight	List Price
9 3/4" depth C						
GRS-18-C	18" x 2 3/8"	120	125	NEMA 5-15P	9 lbs.	\$1012
GRS-24-C	24" x 2 3/8"	120	175	NEMA 5-15P	13 lbs.	826
GRS-30-C	30" x 2 3/8"	120	225	NEMA 5-15P	14 lbs.	871
GRS-36-C	36" x 5 3/8"	120	275	NEMA 5-15P	16 lbs.	912
GRS-42-C	42" x 5 3/8"	120	300	NEMA 5-15P	18 lbs.	1012
GRS-48-C	48" x 5 3/8"	120	350	NEMA 5-15P	20 lbs.	1062
GRS-54-C	54" x 5 3/8"	120	400	NEMA 5-15P	22 lbs.	1085
GRS-60-C	60" x 5 3/8"	120	450	NEMA 5-15P	25 lbs.	1149
GRS-66-C	66" x 5 3/8"	120	500	NEMA 5-15P	28 lbs.	1184
GRS-72-C	72" x 5 3/8"	120	550	NEMA 5-15P	28 lbs.	1223
12" depth D						
GRS-18-D	18" x 2 3/8"	120	200	NEMA 5-15P	12 lbs.	\$ 812
GRS-24-D	24" x 2 3/8"	120	250	NEMA 5-15P	15 lbs.	871
GRS-30-D	30" x 2 3/8"	120	300	NEMA 5-15P	17 lbs.	925
GRS-36-D	36" x 5 3/8"	120	350	NEMA 5-15P	20 lbs.	971
GRS-42-D	42" x 5 3/8"	120	450	NEMA 5-15P	23 lbs.	1080
GRS-48-D	48" x 5 3/8"	120	500	NEMA 5-15P	26 lbs.	1139
GRS-54-D	54" x 5 3/8"	120	550	NEMA 5-15P	30 lbs.	1186
GRS-60-D	60" x 5 3/8"	120	600	NEMA 5-15P	34 lbs.	1236
GRS-66-D	66" x 5 3/8"	120	650	NEMA 5-15P	36 lbs.	1289
GRS-72-D	72" x 5 3/8"	120	700	NEMA 5-15P	37 lbs.	1339
13 3/4" depth E						
GRS-18-E	18" x 2 3/8"	120	200	NEMA 5-15P	13 lbs.	\$ 846
GRS-24-E	24" x 2 3/8"	120	250	NEMA 5-15P	14 lbs.	911
GRS-30-E	30" x 2 3/8"	120	300	NEMA 5-15P	18 lbs.	962
GRS-36-E	36" x 5 3/8"	120	350	NEMA 5-15P	22 lbs.	1025
GRS-42-E	42" x 5 3/8"	120	450	NEMA 5-15P	26 lbs.	1139
GRS-48-E	48" x 5 3/8"	120	500	NEMA 5-15P	29 lbs.	1199
GRS-54-E	54" x 5 3/8"	120	550	NEMA 5-15P	31 lbs.	1260
GRS-60-E	60" x 5 3/8"	120	600	NEMA 5-15P	36 lbs.	1316
GRS-66-E	66" x 5 3/8"	120	650	NEMA 5-15P	38 lbs.	1365
GRS-72-E	72" x 5 3/8"	120	700	NEMA 5-15P	40 lbs.	1434

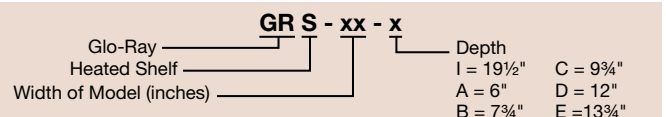

Glo-Ray® Portable Heated Shelves

continued



GRS-60-I



GRS-30-I in optional *Designer Black* with Accessory food pans, shown below a **GRAH-36** Strip Heater in optional *Designer Warm Red*, infinite switch and Accessory C-leg stand

GLO-RAY PORTABLE HEATED SHELVES continued...

Model	Dimensions W x H	Voltage		Plug	Ship Weight	List Price
		Single Phase	Watts			
15½" depth F						
GRS-18-F	18" x 2¾"	120	200	NEMA 5-15P	14 lbs.	\$ 885
GRS-24-F	24" x 2¾"	120	250	NEMA 5-15P	17 lbs.	938
GRS-30-F	30" x 2¾"	120	300	NEMA 5-15P	22 lbs.	1005
GRS-36-F	36" x 5⅜"	120	350	NEMA 5-15P	25 lbs.	1062
GRS-42-F	42" x 5⅜"	120	450	NEMA 5-15P	26 lbs.	1189
GRS-48-F	48" x 5⅜"	120	500	NEMA 5-15P	32 lbs.	1251
GRS-54-F	54" x 5⅜"	120	550	NEMA 5-15P	38 lbs.	1327
GRS-60-F	60" x 5⅜"	120	600	NEMA 5-15P	39 lbs.	1390
GRS-66-F	66" x 5⅜"	120	650	NEMA 5-15P	42 lbs.	1443
GRS-72-F	72" x 5⅜"	120	700	NEMA 5-15P	46 lbs.	1529
15¼" depth G						
GRS-18-G	18" x 2¾"	120	225	NEMA 5-15P	17 lbs.	\$ 900
GRS-24-G	24" x 2¾"	120	300	NEMA 5-15P	18 lbs.	973
GRS-30-G	30" x 2¾"	120	375	NEMA 5-15P	21 lbs.	1041
GRS-36-G	36" x 5⅜"	120	450	NEMA 5-15P	27 lbs.	1107
GRS-42-G	42" x 5⅜"	120	525	NEMA 5-15P	29 lbs.	1249
GRS-48-G	48" x 5⅜"	120	600	NEMA 5-15P	33 lbs.	1319
GRS-54-G	54" x 5⅜"	120	675	NEMA 5-15P	38 lbs.	1393
GRS-60-G	60" x 5⅜"	120	750	NEMA 5-15P	42 lbs.	1465
GRS-66-G	66" x 5⅜"	120	825	NEMA 5-15P	47 lbs.	1478
GRS-72-G	72" x 5⅜"	120	900	NEMA 5-15P	46 lbs.	1596
17½" depth H						
GRS-18-H	18" x 2¾"	120	225	NEMA 5-15P	16 lbs.	\$ 935
GRS-24-H	24" x 2¾"	120	300	NEMA 5-15P	18 lbs.	1021
GRS-30-H	30" x 2¾"	120	375	NEMA 5-15P	21 lbs.	1092
GRS-36-H	36" x 5⅜"	120	450	NEMA 5-15P	27 lbs.	1186
GRS-42-H	42" x 5⅜"	120	525	NEMA 5-15P	32 lbs.	1318
GRS-48-H	48" x 5⅜"	120	600	NEMA 5-15P	35 lbs.	1403
GRS-54-H	54" x 5⅜"	120	675	NEMA 5-15P	40 lbs.	1481
GRS-60-H	60" x 5⅜"	120	750	NEMA 5-15P	44 lbs.	1559
GRS-66-H	66" x 5⅜"	120	825	NEMA 5-15P	49 lbs.	1582
GRS-72-H	72" x 5⅜"	120	900	NEMA 5-15P	50 lbs.	1716

All Glo-Ray Portable Heated Shelf models feature:

Cord Location: 6' cord and plug, located, center of side with switch.

OPTIONS AND ACCESSORIES – PAGE 114

GLO-RAY PORTABLE HEATED SHELVES continued...

Model	Dimensions W x H	Voltage		Plug	Ship Weight	List Price
		Single Phase	Watts			
21½" depth J						
GRS-18-J	18" x 2¾"	120	300	NEMA 5-15P	19 lbs.	\$1063
GRS-24-J	24" x 2¾"	120	375	NEMA 5-15P	24 lbs.	1121
GRS-30-J	30" x 2¾"	120	450	NEMA 5-15P	30 lbs.	1208
GRS-36-J	36" x 5⅜"	120	525	NEMA 5-15P	33 lbs.	1293
GRS-42-J	42" x 5⅜"	120	675	NEMA 5-15P	39 lbs.	1462
GRS-48-J	48" x 5⅜"	120	750	NEMA 5-15P	45 lbs.	1540
GRS-54-J	54" x 5⅜"	120	825	NEMA 5-15P	49 lbs.	1644
GRS-60-J	60" x 5⅜"	120	900	NEMA 5-15P	53 lbs.	1724
GRS-66-J	66" x 5⅜"	120	975	NEMA 5-15P	60 lbs.	1816
GRS-72-J	72" x 5⅜"	120	1050	NEMA 5-15P	64 lbs.	1933
23½" depth K						
GRS-18-K	18" x 2¾"	120	325	NEMA 5-15P	19 lbs.	\$1114
GRS-24-K	24" x 2¾"	120	425	NEMA 5-15P	27 lbs.	1175
GRS-30-K	30" x 2¾"	120	525	NEMA 5-15P	33 lbs.	1265
GRS-36-K	36" x 5⅜"	120	625	NEMA 5-15P	36 lbs.	1363
GRS-42-K	42" x 5⅜"	120	750	NEMA 5-15P	43 lbs.	1529
GRS-48-K	48" x 5⅜"	120	850	NEMA 5-15P	48 lbs.	1628
GRS-54-K	54" x 5⅜"	120	950	NEMA 5-15P	52 lbs.	1723
GRS-60-K	60" x 5⅜"	120	1050	NEMA 5-15P	56 lbs.	1832
GRS-66-K	66" x 5⅜"	120	1150	NEMA 5-15P	68 lbs.	1939
GRS-72-K	72" x 5⅜"	120	1250	NEMA 5-15P	69 lbs.	2031
25½" depth L						
GRS-18-L	18" x 2¾"	120	350	NEMA 5-15P	22 lbs.	\$1167
GRS-24-L	24" x 2¾"	120	475	NEMA 5-15P	26 lbs.	1223
GRS-30-L	30" x 2¾"	120	600	NEMA 5-15P	33 lbs.	1322
GRS-36-L	36" x 5⅜"	120	725	NEMA 5-15P	37 lbs.	1432
GRS-42-L	42" x 5⅜"	120	825	NEMA 5-15P	43 lbs.	1607
GRS-48-L	48" x 5⅜"	120	950	NEMA 5-15P	50 lbs.	1717
GRS-54-L	54" x 5⅜"	120	1075	NEMA 5-15P	58 lbs.	1825
GRS-60-L	60" x 5⅜"	120	1200	NEMA 5-15P	60 lbs.	1930
GRS-66-L	66" x 5⅜"	120	1325	NEMA 5-15P	64 lbs.	2069
GRS-72-L	72" x 5⅜"	120	1450	NEMA 5-15P	69 lbs.	2147

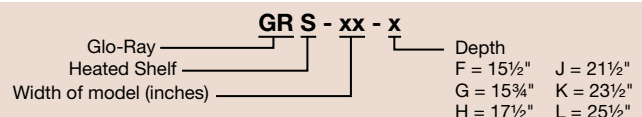



Glo-Ray® Designer Portable Heated Shelves

Using a blanket heating element for an even temperature, the thermostatically-controlled base safely extends the holding time of your food. Hatco's Designer Portable Heated Shelves can blend into any décor.

- Built-in adjustable thermostatic controls
- Rounded edges and Hardcoat Aluminum surface offer a modern style for front-of-the-house applications
- Model widths from 30 1/4" to 78 1/4"
- Optional Dark Gray corner caps (black Standard) and Designer Color inset panels available
- 4" legs Standard on 30" and wider models

GR2S-30 with optional Designer Hunter Green inset panels and Accessory pizza pans



GLO-RAY DESIGNER PORTABLE HEATED SHELVES

Model*	Dimensions (W x D x H) Height includes legs	Voltage Single Phase	Watts	Plug	Ship Weight	List Price
GR2S-24	30 1/4" x 27" x 4"	120	350	NEMA 5-15P	37 lbs.	\$2269
GR2S-30	36 1/4" x 27" x 7"	120	450	NEMA 5-15P	40 lbs.	2438
GR2S-36	42 1/4" x 27" x 7"	120	550	NEMA 5-15P	45 lbs.	2611
GR2S-42	48 1/4" x 27" x 7"	120	600	NEMA 5-15P	51 lbs.	2881
GR2S-48	54 1/4" x 27" x 7"	120	700	NEMA 5-15P	56 lbs.	3055
GR2S-54	60 1/4" x 27" x 7"	120	800	NEMA 5-15P	61 lbs.	3221
GR2S-60	66 1/4" x 27" x 7"	120	900	NEMA 5-15P	67 lbs.	3393
GR2S-66	72 1/4" x 27" x 7"	120	1000	NEMA 5-15P	75 lbs.	3562
GR2S-72	78 1/4" x 27" x 7"	120	1100	NEMA 5-15P	82 lbs.	3734

* When no color is specified, color inset panels and corner caps will be black.

All Glo-Ray Designer Portable Heated Shelf models feature:

Pan Capacity (12" x 20"): GR2S-24 = 1-pan
 GR2S-30, -36 = 2-pan
 GR2S-42, -48 = 3-pan
 GR2S-54, -60 = 4-pan
 GR2S-66, -72 = 5-pan

Usable Heated Shelf Space: (Width of unit minus 6 3/8") x 21 3/4"D.

Cord Location: 6' cord and plug located on center of bottom on control side.

OPTIONS (available at time of purchase only - not available on Quick-Ship)

Designer Colors (top surface not painted) – Clear Anodized standard – Non-standard colors are non-returnable –

RED	Warm Red	\$188
BLACK	Black	188
GRAY	Gray Granite	188
WHITE	White Granite	188
NAVY	Navy Blue	188
GREEN	Hunter Green	188
COPPER	Antique Copper	188

Designer Inset Panel colors, GR2S models – Non-standard colors are non-returnable – Black standard –

RED	Warm Red	No Charge
GRAY	Gray Granite	No Charge
WHITE	White Granite	No Charge
NAVY	Navy Blue	No Charge
GREEN	Hunter Green	No Charge
COPPER	Antique Copper	No Charge

Designer Corner Caps, GR2S models – Non-standard colors are non-returnable – Black standard –

DKGRAY	Dark Gray Corner Caps	No Charge
--------	-----------------------	-----------

Hardcoat Aluminum surface in lieu of Stainless Steel on standard 19 1/2" deep GRS models only (please consult factory for pricing of other depths)

HC 18-42	GRS-18 through GRS-42	\$221
HC 48-72	GRS-48 through GRS-72	374
GRS-RECTH	Thermostat Guard (GRS models only)	No Charge



ACCESSORIES (available for purchase at any time)

GRS-LEGS	4" Adjustable Legs (GRS models only, standard on units GRS-36 and wider)	\$ 60
2SD-LEGS	4" Adjustable Legs for GR2S-24 (standard on GR2S-30 and wider)	112
GRS-SLANT	Slant Leg Kit for models 12" deep or deeper (GRS models only)	30

Pan Rail for – 19 1/2" deep GRS models only –

2 RAIL	2-pan	\$194
3 RAIL	3-pan	210
4 RAIL	4-pan	391
5 RAIL	5-pan	405
THRUSHELF	Bolt and fender washer leg accessory kit for attaching one GRS unit to a wire rack shelf	\$14

FOOD PANS AND TRIVETS – PAGE 240 COLORS AND FINISHES – INSIDE BACK COVER

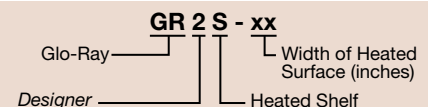

Glo-Ray® Simulated Stone Portable Rectangular Heated Shelves

Match the heat zone to your countertops with Hatco's Glo-Ray® Simulated Stone Portable Rectangular Heated Shelves. These portable foodsafe shelves come in three simulated stone colors and are ideal for buffet lines or as hors d'oeuvre displays. These unique warmers will safely hold food hot while blending in with your décor.

- Made of approved foodsafe materials
- Features a lighted rocker switch and thermostatically-controlled heated base to help hold your food hot and delicious
- Models with simulated stone are Swanstone®



GRSS-3618 in optional Bermuda Sand simulated stone (view of base)



GRSS-3618 in Standard Night Sky simulated stone

GLO-RAY SIMULATED STONE PORTABLE RECTANGULAR HEATED SHELVES

Model	Dimensions W x D x H	Voltage Single Phase	Watts	Plug	Ship Weight	List Price
GRSS-2418	23 ⁷ / ₈ " x 17 ⁷ / ₈ " x 2 ¹ / ₂ "	120	635	NEMA 5-15P	27 lbs.	\$1908
GRSS-3018	29 ⁷ / ₈ " x 17 ⁷ / ₈ " x 2 ¹ / ₂ "	120	780	NEMA 5-15P	30 lbs.	1998
GRSS-3618	35 ⁷ / ₈ " x 17 ⁷ / ₈ " x 2 ¹ / ₂ "	120	930	NEMA 5-15P	35 lbs.	2084
GRSS-4818*	47 ⁷ / ₈ " x 17 ⁷ / ₈ " x 6 ¹ / ₄ "	120	1270	NEMA 5-15P	45 lbs.	2262
GRSS-6018*	59 ⁷ / ₈ " x 17 ⁷ / ₈ " x 6 ¹ / ₄ "	120	1560	NEMA 5-20P	56 lbs.	2955
GRSS-7218*	71 ⁷ / ₈ " x 17 ⁷ / ₈ " x 6 ¹ / ₄ "	120	1860	NEMA 5-20P	68 lbs.	3124

* Height includes standard 4" legs.

All Glo-Ray Simulated Stone Portable Rectangular Heated Shelf models feature:

Cord Location: 6' cord and plug, center of side with switch.

OPTIONS (available at time of purchase only)

Simulated stone colors – Non-standard colors are non-returnable – Night Sky standard –

SS-GGRAN	Gray Granite	No Charge
SS-BSAND	Bermuda Sand	No Charge

COLORS AND FINISHES – INSIDE BACK COVER





Heated Base Glass Portable Rectangular Shelves

The Hatco Heated Base Glass Portable Rectangular Shelves have a heated ceramic glass surface to create uniform heat across the entire surface and are made of approved foodsafe materials. Adjustable thermostatic controls allow surface temperature ranging from 100° to 195° F to be controlled easily.

- Shelves are made of approved foodsafe materials
- Equipped with a Trim Ring that is available in stainless steel (Standard), Designer Black or White
- Lighted On/Off rocker switch
- All units come with a 6' cord and plug
- Surface is made of approved foodsafe materials



HBG-FS-24 Black angled Food Stop (detail view) with **HBG-TRIM-BLK** optional Designer Black trim ring



HBG-2418 in Standard Black Glass and stainless steel trim ring



HBG-2418 with optional White Glass, Frame and Trim Ring

HEATED BASE GLASS PORTABLE RECTANGULAR SHELVES

Model	Dimensions W x D x H	Voltage		Watts	Plug	Ship Weight	List Price
		Single Phase					
HBG-2418	24 $\frac{3}{8}$ " x 18 $\frac{3}{8}$ " x 2 $\frac{1}{2}$ "	120		425	NEMA 5-15P	29 lbs.	\$2563
HBG-3018	30 $\frac{3}{8}$ " x 18 $\frac{3}{8}$ " x 2 $\frac{1}{2}$ "	120		525	NEMA 5-15P	33 lbs.	2680
HBG-3618*	36 $\frac{3}{8}$ " x 18 $\frac{3}{8}$ " x 6 $\frac{1}{8}$ "	120		630	NEMA 5-15P	36 lbs.	2796
HBG-4818*~	48 $\frac{3}{8}$ " x 18 $\frac{3}{8}$ " x 6 $\frac{1}{8}$ "	120		850	NEMA 5-15P	42 lbs.	3030
HBG-6018*~	60 $\frac{3}{8}$ " x 18 $\frac{3}{8}$ " x 6 $\frac{1}{8}$ "	120		1050	NEMA 5-15P	60 lbs.	3263
HBG-7218*~	72 $\frac{3}{8}$ " x 18 $\frac{3}{8}$ " x 6 $\frac{1}{8}$ "	120		1260	NEMA 5-15P	68 lbs.	3495

* Height includes standard 4" legs.
~ Units 48" and larger are constructed of two equal sized pieces of glass which create a seam.

All Heated Base Glass Portable Rectangular Shelf models feature:
Cord Location: 6' cord and plug, center of the side with switch.

OPTIONS (available at time of purchase only)

Ceramic Glass Color – Non-standard colors are non-returnable – Black standard –
HBG-GLASS-WHT White **No Charge**

Angled Food Stop keeps product on the heat zone – Choose size/color

24"	HBG-FS-24	Designer Black	each \$140
30"	HBG-FS-30	Designer Black	each 167
36"	HBG-FS-36	Designer Black	each 194
48"	HBG-FS-48	Designer Black	each 224
60"	HBG-FS-60	Designer Black	each 254
72"	HBG-FS-72	Designer Black	each 286
24"	HBG-FSW-24	White	each \$140
30"	HBG-FSW-30	White	each 167
36"	HBG-FSW-36	White	each 194
48"	HBG-FSW-48	White	each 224
60"	HBG-FSW-60	White	each 254
72"	HBG-FSW-72	White	each 286

Trim Ring – Stainless Steel standard

	HBG-TRIM-BLK	Designer Black	\$46
	HBG-TRIM-WHT	White	46

Frame (base) color – Non-standard colors are non-returnable – Black standard –

	HBG-FRAME-WHT	White	No Charge
--	----------------------	-------	------------------

COLORS AND FINISHES – INSIDE BACK COVER

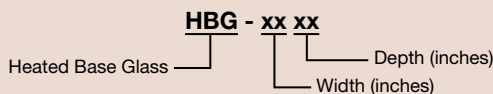

Heated Base Glass Modular Portable Shelf

Hatco's Heated Base Glass Modular Portable Shelf creates uniform heat across the entire top surface. The new design uses a modular system, so units can be placed side-by-side. This allows for marvelous flexibility in buffet areas.

- Unit's glass surface accommodates one 12" x 20" food pan
- Thermostatically-controlled with five settings: 130°F, 150°F, 165°F, 185°F and 200°F
- Durable stainless steel housing
- Simple design for easy cleaning and maintenance
- All units come with a 6' cord and plug, located under control side of unit



HGSM-1P

 **Quick-Ship Model** pages 241-247

HEATED BASE GLASS MODULAR PORTABLE GLASS SHELF

Model ^o	Dimensions W x D x H	Voltage Single Phase	Watts	Plug	Ship Weight	List Price
✓ HGSM-1P	15¾" x 23½" x 2⅝"	120	300	NEMA 5-15P	16 lbs.	\$961

^o No direct food contact on surface - use pans.

The Heated Base Glass Modular Portable Shelf model feature:

Cord Location: 6' cord and plug, located under control side of unit.

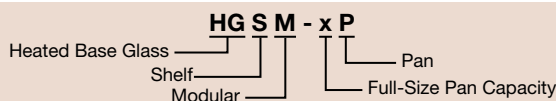



Glo-Ray® Mini-Merchandisers

Hatco's convenient Glo-Ray® Mini-Merchandisers create impulse sales by placing fresh product in front of customers. Using limited amount of valuable counterspace, these flexible warmers come in a variety of shapes, sizes and colors to hold food samples, hors d'oeuvres and packaged product at just the right temperature.

- Ideal for areas with limited counterspace
- Thermostatically-controlled heated base extends holding times of most foods
- Pre-focused infrared top heat directs heat to the outer edges where heat loss is the greatest
- Food stop, 4" food bins are Standard (GRHW-1SG and -1SGS only)
- Lighted rocker switch for easy On/Off



GRHW-1P with Accessory food pan



GRHW-2P with Standard 4" legs and Accessory food pans



GRHW-1SG with Standard bins



GRHW-1SGDS in Standard Designer Black

GLO-RAY MINI-MERCHANDISERS

Model	Description	Dimensions W x D x H Includes sneeze guard	Voltage Single Phase	Watts	Plug	Base/Shelf Dimensions W x D	Ship Weight	List Price
Single Shelf								
GRHW-1P	Hors d'oeuvres warmer, 2 bulbs	22¼" x 16⅝" x 17¾"	120	820	NEMA 5-15P	21" x 13¾"	35 lbs.	\$1964
GRHW-2P [▲]	Hors d'oeuvres warmer, 4 bulbs	43¼" x 16⅝" x 20¾"	120	1640	NEMA 5-15P	42" x 13¾"	67 lbs.	2609
GRHW-1SG	Single horizontal shelf, 2 bulbs	22¼" x 16⅝" x 17¾"	120	820	NEMA 5-15P	21" x 13¾"	37 lbs.	2352
GRHW-1SGS	Single slanted shelf, 2 bulbs	22¼" x 16⅝" x 18¼"	120	820	NEMA 5-15P	21" x 14¼"	40 lbs.	2353
Dual Shelf								
GRHW-1SGD	Dual shelf, 4 bulbs	22⅞" x 20⅓" x 23½"	120	1330	NEMA 5-15P	Bottom: 21" x 13¼" Top: 21" x 14"	40 lbs.	\$4467
GRHW-1SGDS	Hardcoat & slanted base, 4 bulbs	22⅝" x 21" x 23⅝"	120	1330	NEMA 5-15P	Bottom: 21" x 14¼" Top: 21" x 14"	40 lbs.	4665

▲ Canada uses 5-20P

All Glo-Ray Mini-Merchandiser models feature:

Included with Merchandiser: Thermostatically-controlled base, 7½" sneeze guard, display lights, 1" rubber legs (except GRHW-2P has 4" legs), five 4" bins (GRHW-1SG, -1SGS only), 6' cord and plug.

Cord Location: GRHW-1SGD, -1SGDS: Control side, bottom right.

All Other Models: 6' cord and plug, base end plate, same side as switch.

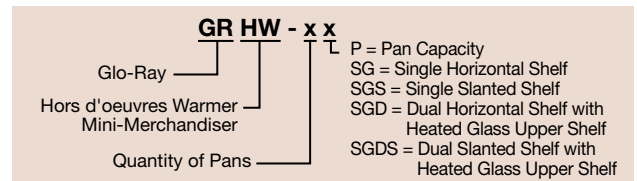

OPTIONS (available at time of purchase only)

Designer Colors – Non-standard colors are non-returnable – Clear Anodized Aluminum standard – (Designer Color included on GRHW-1SGD, 1SGDS units, Designer Black standard)

RED	Warm Red	\$460
BLACK	Black (standard on GRHW-1SGD, 1SGDS units)	460
GRAY	Gray Granite	460
WHITE	White Granite	460
NAVY	Navy Blue	460
GREEN	Hunter Green	460
COPPER	Antique Copper	460
HAL	60 Watt Halogen Bulb in lieu of standard Display Light	each \$ 63
PANEL	Plexi-Glass Side Panels (GRHW-1P, -2P, -1SG only)	218
1SGD-SLOPE	Sloped Front Sign Holder (GRHW-1SGD, -1SGDS units)	104

ACCESSORIES (available for purchase at any time)

4"LEGS	4" Adjustable Legs (GRHW-1P, -1SG only) – Standard on GRHW-2P	\$ 60
Chef LED 120V adjustable bulb – bulbs must be rotated down – see page 63 for more information –		each 129
CLED-2700-120	Similar to warm Incandescent	CLED-3000-120 Similar to warm Halogen light
CLED-4000-120	Similar to cool Fluorescent light	

FOOD PANS AND TRIVETS – PAGE 240
COLORS AND FINISHES – INSIDE BACK COVER



Chef LED Bulb

Glo-Ray® Buffet Warmers

Hold hot food at optimum serving temperatures on buffet lines or at temporary serving areas with Hatco Glo-Ray® Buffet Warmers. Choose from either Standard or Designer style models in many widths to fit your operation.

- Available with Designer Color insets with the choice of an entire unit in color as well
- Thermostatically-controlled heated base of 80°- 200°F extends holding times of most foods
- Pre-focused infrared top heat directs heat to the outer edges where heat loss is greatest
- Sturdy plexi-glass Sneeze Guard
- Shatter-resistant incandescent lights enhance product displays while safeguarding food from bulb breakage
- Available in a variety of widths from 25"-78¼"
- Optional infinite control for top heat only



GRBW-30 in optional Designer Navy Blue and Accessory food pans



GR2BW-30 with optional Designer Warm Red inset panels and Accessory food pans



GR2BW-30 in optional Designer Black and plexi-glass side enclosures plus Accessory food pans

Quick-Ship Model pages 241-247

GLO-RAY BUFFET WARMERS

Model	No. of Light Bulbs	Dimensions W x D x H Includes sneeze guard	Maximum Pan Capacity 12" x 20" pan	Voltage	Watts	Plug	Ship Weight	List Price
✓ GRBW-24 [†]	2	25" x 22½" x 17¾"	1	120	970	NEMA 5-15P	46 lbs.	\$2135
GRBW-30 [†]	2	31" x 22½" x 17¾"	2	120	1230	NEMA 5-15P	52 lbs.	2363
✓ GRBW-36 ^{†▲}	3	37" x 22½" x 20¾"	2	120	1530	NEMA 5-15P	58 lbs.	2591
GRBW-42 ^{†▲}	3	43" x 22½" x 20¾"	3	120	1730	NEMA 5-15P	68 lbs.	2819
✓ GRBW-48 ^{†*}	4	49" x 22½" x 20¾"	3	120	2040	NEMA 5-20P	75 lbs.	3047
GRBW-54	4	55" x 22½" x 20¾"	4	120/208-240	2290	NEMA L14-20P	81 lbs.	3275
GRBW-60	5	61" x 22½" x 20¾"	4	120/208-240	2600	NEMA L14-20P	90 lbs.	3503
GRBW-66	5	67" x 22½" x 20¾"	5	120/208-240	2860	NEMA L14-20P	96 lbs.	3731
GRBW-72	5	73" x 22½" x 20¾"	5	120/208-240	3125	NEMA L14-20P	107 lbs.	3959

† Available in 120/208-240V, NEMA L14-20P.

▲ Canadian models use NEMA 5-20P.

✓ Quick-Ship models are 120V. Not available for Canada.

* Not available in 120V for Canada.

All Glo-Ray Buffet Warmer models feature:

GRBW base dimensions: 25"-73"W x 19½"D.

Cord Location: 6' cord and plug located on base end plate, same side as switch.

GLO-RAY DESIGNER BUFFET WARMERS

Model*	No. of Light Bulbs	Dimensions W x D x H Includes sneeze guard	Maximum Pan Capacity 12" x 20" pan	Voltage	Watts	Plug	Ship Weight	List Price
GR2BW-24 [†]	2	30¼" x 27" x 19"	1	120	970	NEMA 5-15P	76 lbs.	\$3811
GR2BW-30 [†]	2	36¼" x 27" x 22"	2	120	1230	NEMA 5-15P	85 lbs.	4170
GR2BW-36 ^{†▲}	2	42¼" x 27" x 22"	2	120	1470	NEMA 5-15P	97 lbs.	4529
GR2BW-42 ^{†▲}	4	48¼" x 27" x 22"	3	120	1790	NEMA 5-15P	110 lbs.	5006
GR2BW-48 ^{†*}	4	54¼" x 27" x 22"	3	120	2040	NEMA 5-20P	125 lbs.	5483
GR2BW-54 ^{†*}	4	60¼" x 27" x 22"	4	120	2290	NEMA 5-20P	130 lbs.	6053
GR2BW-60	6	66¼" x 27" x 22"	4	120/208-240	2660	NEMA L14-20P	154 lbs.	6623
GR2BW-66	6	72¼" x 27" x 22"	5	120/208-240	2920	NEMA L14-20P	169 lbs.	7089
GR2BW-72	6	78¼" x 27" x 22"	5	120/208-240	3185	NEMA L14-20P	186 lbs.	7555

* When no color is specified, color inset panels and corner caps will be black.

† Available in 120/208-240V, NEMA L14-20P.

▲ Canadian models use NEMA 5-20P.

* Not available in 120V for Canada.

All Glo-Ray Designer Buffet Warmer models feature:

Usable Heated Shelf Space: Width of unit minus 6½" x 21¾"D.

Cord Location: 6' cord and plug located on center of bottom on control side.

OPTIONS AND ACCESSORIES – PAGE 120

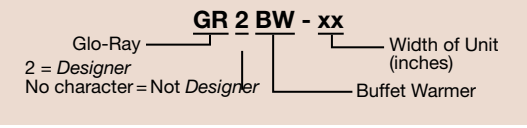



**GRBW-30 with
Accessory Food Pans**

OPTIONS (available at time of purchase only – not available on Quick-Ship)

Designer Colors – Non-standard colors are non-returnable – Clear Anodized Aluminum standard –

RED	Warm Red	\$460
BLACK	Black	460
GRAY	Gray Granite	460
WHITE	White Granite	460
NAVY	Navy Blue	460
GREEN	Hunter Green	460
COPPER	Antique Copper	460

Designer Inset Panel colors, GR2BW models – Non-standard colors are non-returnable – Black standard –

RED	Warm Red	No Charge
GRAY	Gray Granite	No Charge
WHITE	White Granite	No Charge
NAVY	Navy Blue	No Charge
GREEN	Hunter Green	No Charge
COPPER	Antique Copper	No Charge

Designer Corner Caps, GR2BW models – Non-standard colors are non-returnable – Black standard –

DKGRAY	Dark Gray	No Charge
---------------	-----------	------------------

Plexi-Glass Front and two Side Enclosures in lieu of Sneeze Guards – Available for GRBW-24, -30, -36, -42 and -48 models only –

FRTENCL-24, -30	-24 and -30 models	\$419
FRTENCL-36, -42, -48	-36, -42, & -48 models	478
SIDE-ENCL	Two Plexi-Glass Side Enclosures (GRBW models only)	285
SIDE-ENCL2	Two Plexi-Glass Side Enclosures (GR2BW models only)	285

Hardcoat Aluminum Surface, GRBW models –

HC 24-42	GRBW-24 through GRBW-42	\$149
HC 48-72	GRBW-48 through GRBW-72	298
INF	Infinite Control for top heat only (GRBW-24 through GRBW-60 and GR2BW-24 through GR2BW-60 models only)	\$47
9.375BP	9 3/8" Sneeze Guard in lieu of standard 7 1/2" (GRBW models only)	per foot per side 13
14BP	14" Sneeze Guard in lieu of standard 7 1/2"	per foot per side 25
HAL	60 Watt Halogen Bulb in lieu of standard Display Light	each 63

ACCESSORIES

GRBW-LEGS	4" adjustable legs for GRBW-24 models (standard on GRBW-36 or wider)	\$ 60
2SD-LEGS	4" Designer Legs for GR2BW-24 models (standard on GR2BW-30 or wider)	112
Pan Rail for GRBW models (not for use with Plexi-Glass front enclosure)		
2 RAIL	2-pan	\$194
3 RAIL	3-pan	210
4 RAIL	4-pan	391
5 RAIL	5-pan	405
Chef LED 120V adjustable bulb – bulbs must be rotated down – see page 63 for more information –		each 129
CLED-2700-120 Similar to warm Incandescent CLED-3000-120 Similar to warm Halogen light CLED-4000-120 Similar to cool Fluorescent light		

**FOOD PANS AND TRIVETS – PAGE 240
COLORS AND FINISHES – INSIDE BACK COVER**



Chef LED Bulb



2 RAIL

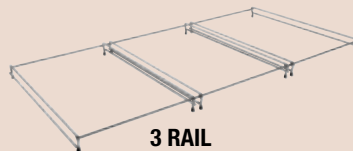

3 RAIL



2SD-LEGS

Built-Ins

Cafeterias • Buffets
Supermarkets & Delis • Restaurants & Cafés

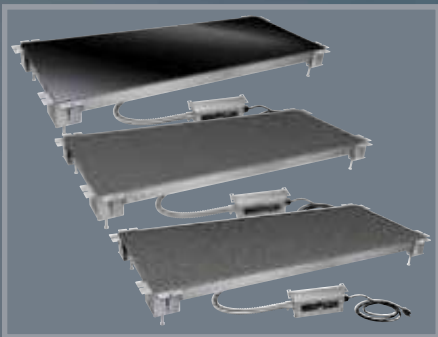

HSBF-GL-4818 in standard Black Ceramic Glass, **HSBF-HC-4818** in standard Hardcoat Aluminum, **HSBF-SS-4818** in standard Night Sky Simulated Stone *pg. 122-124*



CSSBF-48-S in optional Bermuda Sand simulated stone built into a Bermuda Sand simulated stone countertop *pg. 126*



HCSBF-48-S (Hardcoat Aluminum) in cold mode *pg. 135*



GRSSB-3618 in optional Bermuda Sand simulated stone (shown below an Antique Copper **GR2AHL-42** Strip Heater with optional Sneeze Guards and Designer non-adjustable tubular stands) *pg. 137*



GRSSB-3618 in standard Night Sky simulated stone built into a granite countertop *pg. 137*



HBGB-3618 in standard Black Glass (shown below a **GR2AHL-42** Strip Heater with Designer non-adjustable tubular stands, optional Sneeze Guards) *pg. 138*

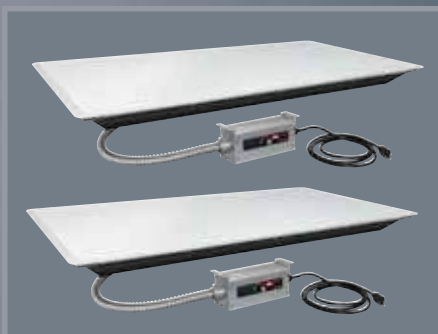

HBGB-3618 with optional Trim Ring in new optional White Glass *pg. 138*



GRSB-54-I (Hardcoat Aluminum) and accessory food pans (shown below a **GRAL-96D** Strip Heater with optional Sneeze Guards) *pg. 139*



GRSBF-60-0 (Anodized Aluminum) built into a simulated stone countertop with accessory food pans, (shown below a **GR2AL-96D** Strip Heater in Designer Black with optional Sneeze Guards) *pg. 141*



July 1, 2022

Heated Shelves Built-In Flush - Ceramic Glass

Give your operation a seamless look with the Heated Shelf Built-In Flush-Ceramic Glass. The bracket mounting hardware gives a true flush mount appearance that will safely hold food hot while blending with your decor. It is a must for buffet lines in cafeterias, restaurants and more!

- Standard Black or optional white Ceramic Glass surface
- All models have a Ceramic Glass surface and are bottom mount, flush with the countertop
- Blanket-type element with thermostatically-controlled heated base results in uniform heat to extend food holding times
- Insulation keeps heat at the holding surface while a built-in adjustable thermostat controls surface temperature.
- Standard control includes thermostat, lighted rocker switch and mounting brackets
- 3' Conduit is standard – Option: with ITC Control Boxes only, 6' and 10' lengths are available



HSBF-GL-4818
in standard
Black Glass



HSBF-GL-4818
in optional
White Glass

HEATED SHELVES BUILT-IN FLUSH - CERAMIC GLASS

Model [^]	Overall Shelf Dimensions (includes brackets) W x D x H	Heated Shelf Space W x D	Cutout Size (with 3/8" corner radii) W x D	Voltage Single Phase	Watts	Amps	List Price
HSBF-GL-2418	27" x 21 1/8" x 5 1/2"	24" x 18"	24 1/4" x 18 3/8"	120	425	3.5	\$2899
HSBF-GL-3018	33" x 21 1/8" x 5 1/2"	30" x 18"	30 1/4" x 18 3/8"	120	525	4.4	3021
HSBF-GL-3618	39" x 21 1/8" x 5 1/2"	36" x 18"	36 1/4" x 18 3/8"	120	630	5.3	3150
HSBF-GL-4818	51" x 21 1/8" x 5 1/2"	48" x 18"	48 1/4" x 18 3/8"	120	850	7.1	3452

[^] Recommended for use in a metallic countertop. For other surfaces, verify that the material is suitable for temperatures up to 200°F. Hatco is not responsible for counter damage caused by heat from the warmer.

All Heated Shelf Built-In Flush-Ceramic Glass models feature:

- Control Box:** Flush Mount Electronic Temperature Control with 3' conduit
- Cord Location:** Cord is attached to Control Box.
- Cord and Plug:** 6' cord and plug (NEMA 5-15P).

OPTIONS (available at time of purchase only)

Ceramic Glass Color – Black standard –		No Charge
HSBF-GLASS-WHT	White	
Designer Color for Flush Mount Control Bezel – Stainless Steel standard – Non-standard colors are non-returnable		
RED	Warm Red	\$ 46
BLACK	Black	46
GRAY	Gray Granite	46
WHITE	White Granite	46
NAVY	Navy Blue	46
GREEN	Hunter Green	46
COPPER	Antique Copper	46
HSBF-FLUSH-ITC	Stainless steel Flush Mount Recessed Electronic Control Box with lighted On/Off rocker switch and angled recessed controls (6 7/16" W x 7 13/16" H x 5 9/32" D)	196
HSBF-SMFLUSH-ITC	Flush Mount Electronic Control Box with lighted On/Off rocker switch (8 1/2" W x 4" H x 3 13/16" D)	196
HSBF-FLUSH-TSTAT	Stainless steel Flush Mount Recessed Thermostatic Control Box with lighted On/Off rocker switch and angled recessed controls (6 7/16" W x 7 13/16" H x 4 17/32" D)	No Charge
HSBF-SMFLUSH-TSTAT	Flush Mount Thermostatic Control Box with lighted On/Off rocker switch (8 1/2" W x 3 11/16" H x 3 15/16" D)	No Charge
COND-6	6' Conduit (3' standard) – used with Flush Mount and Small Flush Mount ITC Control Boxes only)	45
COND-10	10' Conduit (3' standard) (used with Flush Mount and Small Flush Mount ITC Control Boxes only)	86



HSBF-FLUSH-ITC HSBF-FLUSH-TSTAT



HSBF-SMFLUSH-ITC



HSBF-SMFLUSH-TSTAT

COLORS AND FINISHES – INSIDE BACK COVER

OPTIONAL CONTROL BOX CUTOUT DIMENSIONS

Model	Width	Height	Depth
HSBF-FLUSH-ITC	5 7/8"	6 3/8"	4 7/8"
HSBF-FLUSH-TSTAT	5 7/8"	6 3/8"	4"
HSBF-SMFLUSH-ITC	6 3/4"	3 3/4"	3 3/8"
HSBF-SMFLUSH-TSTAT	6 3/4"	3 7/8"	3 25/64"



Heated Shelves Built-In Flush - Hardcoat Aluminum

Give your operation a seamless look with the Heated Shelf Built-In Flush-Hardcoat Aluminum. The bracket mounting hardware gives a true flush mount appearance that will safely hold food hot while blending with your decor. It is a must for buffet lines in cafeterias, restaurants and more!

- All models have a Hardcoat Aluminum surface and are bottom mount, flush with the countertop
- Blanket-type element with thermostatically-controlled heated base results in uniform heat to extend food holding times
- Insulation keeps heat at the holding surface while a built-in adjustable thermostat controls surface temperature
- Standard control includes thermostat, lighted rocker switch and mounting brackets
- 3' Conduit is standard – Option: with ITC Control Boxes only, 6' and 10' lengths are available



HEATED SHELVES BUILT-IN FLUSH - HARDCOAT ALUMINUM

Model [^]	Overall Shelf Dim. (includes brackets) W x D x H	Heated Shelf Space W x D	Cutout Size (with 3/8" corner radii) W x D	Voltage Single Phase	Watts	Amps	List Price
HSBF-HC-2418	27 1/8" x 21 1/8" x 5 11/32"	24" x 18"	24 3/8" x 18 3/8"	120	425	3.5	\$1787
HSBF-HC-2424	27 1/8" x 27 1/8" x 5 11/32"	24" x 24"	24 3/8" x 24 3/8"	120	680	5.7	1794
HSBF-HC-2430	27 1/8" x 33 1/8" x 5 11/32"	24" x 30"	24 3/8" x 30 3/8"	120	790	6.6	1949
HSBF-HC-3018	33 1/8" x 21 1/8" x 5 11/32"	30" x 18"	30 3/8" x 18 3/8"	120	525	4.4	1904
HSBF-HC-3024	33 1/8" x 27 1/8" x 5 11/32"	30" x 24"	30 3/8" x 24 3/8"	120	815	6.8	1912
HSBF-HC-3030	33 1/8" x 33 1/8" x 5 11/32"	30" x 30"	30 3/8" x 30 3/8"	120	950	7.9	2121
HSBF-HC-3618	39 1/8" x 21 1/8" x 5 11/32"	36" x 18"	36 3/8" x 18 3/8"	120	630	5.3	2024
HSBF-HC-3624	39 1/8" x 27 1/8" x 5 11/32"	36" x 24"	36 3/8" x 24 3/8"	120	950	7.9	2033
HSBF-HC-3630	39 1/8" x 33 1/8" x 5 11/32"	36" x 30"	36 3/8" x 30 3/8"	120	1110	9.3	2362
HSBF-HC-4218	45 1/8" x 21 1/8" x 5 11/32"	42" x 18"	42 3/8" x 18 3/8"	120	735	6.1	2124
HSBF-HC-4224	45 1/8" x 27 1/8" x 5 11/32"	42" x 24"	42 3/8" x 24 3/8"	120	1090	9.1	2135
HSBF-HC-4230	45 1/8" x 33 1/8" x 5 11/32"	42" x 30"	42 3/8" x 30 3/8"	120	1270	10.6	2594
HSBF-HC-4818	51 1/8" x 21 1/8" x 5 11/32"	48" x 18"	48 3/8" x 18 3/8"	120	850	7.1	2238
HSBF-HC-4824	51 1/8" x 27 1/8" x 5 11/32"	48" x 24"	48 3/8" x 24 3/8"	120	1225	10.2	2249
HSBF-HC-4830	51 1/8" x 33 1/8" x 5 11/32"	48" x 30"	48 3/8" x 30 3/8"	120	1430	11.9	2795

[^] Recommended for use in a metallic countertop. For other surfaces, verify that the material is suitable for temperatures up to 200°F. Hatco is not responsible for counter damage caused by heat from the warmer.

All Heated Shelf Built-In Flush-Hardcoat Aluminium models feature:

- Control Box:** Flush Mount Electronic Temperature Control with 3' conduit.
- Cord Location:** Cord is attached to Control Box.
- Cord and Plug:** 6' cord and plug (NEMA 5-15P).

OPTIONS (available at time of purchase only)

Designer Color for Flush Mount Control Bezel – Stainless Steel standard – Non-standard colors are non-returnable –

RED	Warm Red	\$ 46
BLACK	Black	46
GRAY	Gray Granite	46
WHITE	White Granite	46
NAVY	Navy Blue	46
GREEN	Hunter Green	46
COPPER	Antique Copper	46

HSBF-FLUSH-ITC	Stainless steel Flush Mount Recessed Electronic Control Box with lighted On/Off rocker switch and angled recessed controls (6 7/16" W x 7 13/16" H x 5 9/32" D)	196
HSBF-SMFLUSH-ITC	Flush Mount Electronic Control Box with lighted On/Off rocker switch (8 1/2" W x 4" H x 3 13/16" D)	196
HSBF-FLUSH-TSTAT	Stainless steel Flush Mount Recessed Thermostatic Control Box with lighted On/Off rocker switch and angled recessed controls (6 7/16" W x 7 13/16" H x 4 17/32" D)	No Charge
HSBF-SMFLUSH-TSTAT	Flush Mount Thermostatic Control Box with lighted On/Off rocker switch (8 1/2" W x 3 11/16" H x 3 15/16" D)	No Charge
COND-6	6' Conduit (3' standard) – used with Flush Mount and Small Flush Mount ITC Control Boxes only)	45
COND-10	10' Conduit (3' standard) (used with Flush Mount and Small Flush Mount ITC Control Boxes only)	86

COLORS AND FINISHES – INSIDE BACK COVER

OPTIONAL CONTROL BOX CUTOUT DIMENSIONS

Model	Width	Height	Depth
HSBF-FLUSH-ITC	5 7/8"	6 3/8"	4 7/8"
HSBF-FLUSH-TSTAT	5 7/8"	6 3/8"	4"
HSBF-SMFLUSH-ITC	6 3/4"	3 3/4"	3 5/8"
HSBF-SMFLUSH-TSTAT	6 3/4"	3 1/16"	3 25/64"



HSBF-FLUSH-ITC



HSBF-FLUSH-TSTAT



HSBF-SMFLUSH-ITC



HSBF-SMFLUSH-TSTAT

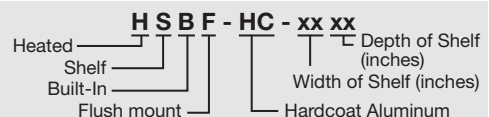



July 1, 2022

Heated Shelves Built-In Flush - Simulated Stone

Give your operation a seamless look with the Heated Shelf Built-In Flush-Simulated Stone. The bracket mounting hardware gives a true flush mount appearance that will safely hold food hot while blending with your decor. It is a must for buffet lines in cafeterias, restaurants and more!

- The Simulated Stone unit mounts directly to underside of appropriate countertop material
- Simulated stone is Swanstone®
- Blanket-type element with thermostatically-controlled heated base results in uniform heat to extend food holding times
- Insulation keeps heat at the holding surface while a built-in adjustable thermostat controls surface temperature.
- Standard control includes thermostat, lighted rocker switch and mounting brackets
- 3' Conduit is standard – Option: with ITC Control Boxes only, 6' and 10' lengths are available

HSBF-SS-4818
in standard Night Sky



HSBF-SS-4818
in optional Gray Granite



HSBF-SS-4818
in optional Bermuda Sand



HEATED SHELVES BUILT-IN FLUSH - SIMULATED STONE

Model [^]	Overall Shelf Dimensions (includes brackets) W x D x H	Heated Shelf Space W x D	Cutout Size (with 3/8" corner radii) W x D	Voltage Single Phase	Watts	Amps	List Price
HSBF-SS-2418	27" x 21 x 5 5/8"	24" x 18"	24 3/8" x 18 3/8"	120	635	5.3	\$2139
HSBF-SS-3018	33" x 21 x 5 5/8"	30" x 18"	30 3/8" x 18 3/8"	120	780	6.5	2226
HSBF-SS-3618	39" x 21 x 5 5/8"	36" x 18"	36 3/8" x 18 3/8"	120	930	7.8	2320
HSBF-SS-4818	51" x 21 x 5 5/8"	48" x 18"	48 3/8" x 18 3/8"	120	1270	10.6	2630

[^] Recommended for use in a metallic countertop. For other surfaces, verify that the material is suitable for temperatures up to 200°F. Hatco is not responsible for counter damage caused by heat from the warmer.

All Heated Shelf Built-In Flush-Simulated Stone models feature:

Control Box: Flush Mount Electronic Temperature Control with 3' conduit.

Cord Location: Cord is attached to Control Box.

Cord and Plug: 6' cord and plug (NEMA 5-15P).

OPTIONS (available at time of purchase only)

Simulated stone colors – Non-standard colors are non-returnable – Night Sky standard –

SS-GGRAN	Gray Granite	No Charge
SS-BSAND	Bermuda Sand	No Charge

Designer Color for Flush Mount Control Bezel – Stainless Steel standard – Non-standard colors are non-returnable

RED	Warm Red	\$ 46
BLACK	Black	46
GRAY	Gray Granite	46
WHITE	White Granite	46
NAVY	Navy Blue	46
GREEN	Hunter Green	46
COPPER	Antique Copper	46

HSBF-FLUSH-ITC	Stainless steel Flush Mount Recessed Electronic Control Box with lighted On/Off rocker switch and angled recessed controls (6 7/16" W x 7 13/16" H x 5 7/32" D)	196
-----------------------	---	------------

HSBF-SMFLUSH-ITC	Flush Mount Electronic Control Box with lighted On/Off rocker switch (8 1/2" W x 4" H x 3 13/16" D)	196
-------------------------	---	------------

HSBF-FLUSH-TSTAT	Stainless steel Flush Mount Recessed Thermostatic Control Box with lighted On/Off rocker switch and angled recessed controls (6 7/16" W x 7 13/16" H x 4 17/32" D)	No Charge
-------------------------	--	------------------

HSBF-SMFLUSH-TSTAT	Flush Mount Thermostatic Control Box with lighted On/Off rocker switch (8 1/2" W x 3 11/16" H x 3 15/16" D)	No Charge
---------------------------	---	------------------

COND-6	6' Conduit (3' standard) – used with Flush Mount and Small Flush Mount ITC Control Boxes only)	\$45
---------------	--	-------------

COND-10	10' Conduit (3' standard) (used with Flush Mount and Small Flush Mount ITC Control Boxes only)	86
----------------	--	-----------

COLORS AND FINISHES – INSIDE BACK COVER

OPTIONAL CONTROL BOX CUTOUT DIMENSIONS

Model	Width	Height	Depth
HSBF-FLUSH-ITC	5 7/8"	6 3/8"	4 7/8"
HSBF-FLUSH-TSTAT	5 7/8"	6 3/8"	4"
HSBF-SMFLUSH-ITC	6 3/4"	3 3/4"	3 5/8"
HSBF-SMFLUSH-TSTAT	6 3/4"	3 1/16"	3 25/64"



HSBF-FLUSH-ITC

HSBF-FLUSH-TSTAT



HSBF-SMFLUSH-ITC

HSBF-SMFLUSH-TSTAT

Fixed

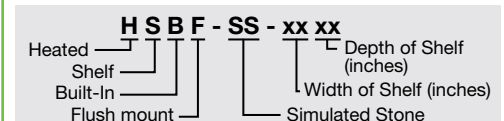

Cold Simulated Stone Shelves Built-In

Hatco's Cold Simulated Stone Shelves Built-In are a must for buffet lines in cafeterias, restaurants and much more!

CSSBR and CSSBX have benefit of allowing fabricators the freedom to design.

- Patented thermal break reduces condensation and temperature transfer on adjacent surfaces
- All models are bottom mount units
- Simulated stone is Swanstone®
- All models match the GRSSB Heated Simulated Stone Built-In Shelves for a fully integrated look
- Control Box comes with standard 4' lead wire
- Control Box can be mounted 4' from center of the shelf (CSSB models only)

- Condensing unit may be mounted up to 4' away from center of shelf (CSSB models only)
- Condensing unit features easy serviceability with sight glass, service valves, dryer/filter and receiver (CSSB, CSSBR models only)
- CSSB models offer a long, flexible, refrigerant line which allows condensing unit to be pulled out for service
- CSSBR models have unattached Condensing unit and Control Box, CSSBX models have unattached Control Box only



CSSB-4818
in optional Bermuda Sand simulated stone



CSSBR-4818
in standard Night Sky simulated stone – All models come with unattached Condenser and Control Box



CSSBX-4818
All models come with unattached Control Box only

COLD SIMULATED STONE SHELVES BUILT-IN (flush to countertop)

Model	Overall Shelf Dimensions (includes brackets)		Voltage Single Phase	Watts	Hz	Comp. Size HP	Approx. Ship Weight	List Price
	W x D	Shelf Space W x D						
CSSB-2418	27" x 21"	24" x 18"	120	300	60	1/5	126 lbs.	\$7599
CSSB-3018	33" x 21"	30" x 18"	120	300	60	1/5	132 lbs.	7678
CSSB-3618	39" x 21"	36" x 18"	120	300	60	1/5	145 lbs.	7921
CSSB-4818	51" x 21"	48" x 18"	120	450	60	1/3	172 lbs.	8988

All Cold Simulated Stone Shelf Built-In models feature:

Models Shipped with: Electronic Temperature Control and a condensing unit, 6' cord and plug (NEMA 5-15P).

COLD SIMULATED STONE SHELVES BUILT-IN with UNATTACHED CONDENSER/CONTROL BOX (flush to counter top)

Model	Overall Shelf Dimensions (includes brackets)		Voltage Single Phase	Watts	Hz	Comp. Size HP	Approx. Ship Weight	List Price
	W x D	Shelf Space W x D						
CSSBR-2418	27" x 21"	24" x 18"	120	300	60	1/5	88 lbs.	\$6752
CSSBR-3018	33" x 21"	30" x 18"	120	300	60	1/5	126 lbs.	6831
CSSBR-3618	39" x 21"	36" x 18"	120	300	60	1/5	139 lbs.	7074
CSSBR-4818	51" x 21"	48" x 18"	120	450	60	1/3	164 lbs.	8141

All Cold Simulated Stone Shelf Built-In with Unattached Condenser/Control Box models feature:

Models Shipped with: Shelf assembly with temperature probe, Control Box, condensing unit and TXV (all shipped loose).

COLD SIMULATED STONE SHELVES BUILT-IN with UNATTACHED CONTROL BOX only (flush to counter top)

Model	Overall Shelf Dimensions (includes brackets)		Watts 120V Single Phase	Hz	Approx. Ship Weight	List Price
	W x D	Shelf Space W x D				
CSSBX-2418	27" x 21"	24" x 18"	12	60	75 lbs.	\$5678
CSSBX-3018	33" x 21"	30" x 18"	12	60	87 lbs.	5757
CSSBX-3618	39" x 21"	36" x 18"	12	60	99 lbs.	6000
CSSBX-4818	51" x 21"	48" x 18"	12	60	125 lbs.	7067

All Cold Simulated Stone Shelf Built-In with Unattached Control Box Only models feature:

Models Shipped with: Shelf assembly with temperature probe, solenoid valve (attached to shelf), Control Box (shipped loose) and TXV (unattached).

COUNTERTOP CUTOUT DIMENSIONS

Model	Width with 3/8" radii	Height with 3/8" radii
CSSB(R)(X)-2418	24 3/8"	18 3/8"
CSSB(R)(X)-3018	30 3/8"	18 3/8"
CSSB(R)(X)-3618	36 3/8"	18 3/8"
CSSB(R)(X)-4818	48 3/8"	18 3/8"

Model	Width	Height
Control Box	9 1/2"	7 3/4"

OPTIONS

(available at time of purchase only)

Simulated stone colors – Non-standard colors are non-returnable – Night Sky standard –

SS-GGRAN Gray Granite **No Charge**

SS-BSAND Bermuda Sand **No Charge**

COND-8.5 102" cord (60" standard), CSSB models only **\$ 14**

EWC (Additional four year extended Parts Only Warranty on the compressor available at the time of unit purchase CSSB, CSSBR models only) **200**

COLORS AND FINISHES – INSIDE BACK COVER

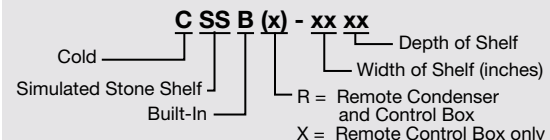



July 1, 2022

Cold Simulated Stone Shelves Built-In Flush Top

Hatco's new, sturdy Cold Simulated Stone Shelves Built-In Flush Top are a must for buffet lines in cafeterias, restaurants and more!

- Patented thermal break reduces condensation and temperature transfer on adjacent surfaces
- All models are bottom mount units
- Control Box comes standard with a 4' lead wire
- Control Box can be mounted 4' from center of the shelf (CSSBF models only)

- CSSBF models offer a long, flexible, refrigerant line which allows condensing unit to be pulled out for service
 - Condensing unit features easy serviceability with sight glass, service valves, dryer/filter and receiver (CSSBF, CSSBFR models only)
 - Simulated stone is Swanstone®
- continued on next page...*



CSSBF-48-S
in standard Night Sky simulated stone



CSSBFR-48-S
in optional Bermuda Sand – All models come with unattached Condenser and Control Box



COLD SIMULATED STONE SHELVES BUILT-IN FLUSH TOP

Model	Overall Shelf Dimensions (includes brackets) W x D	Shelf Space W x D	Voltage Single Phase	Watts	Hz	Comp. Size HP	Approx. Ship Weight	List Price
CSSBF-24-F	27" x 18½"	24" x 15½"	120	300	60	1/5	119 lbs.	\$ 7586
CSSBF-24-I	27" x 22½"	24" x 19½"	120	300	60	1/5	124 lbs.	7618
CSSBF-24-S	27" x 27"	24" x 24"	120	300	60	1/5	134 lbs.	7864
CSSBF-36-F	39" x 18½"	36" x 15½"	120	300	60	1/5	138 lbs.	7885
CSSBF-36-I	39" x 22½"	36" x 19½"	120	450	60	1/3	155 lbs.	7918
CSSBF-36-S	39" x 27"	36" x 24"	120	450	60	1/3	164 lbs.	9321
CSSBF-48-F	51" x 18½"	48" x 15½"	120	450	60	1/3	159 lbs.	8954
CSSBF-48-I	51" x 22½"	48" x 19½"	120	450	60	1/3	171 lbs.	8987
CSSBF-48-S	51" x 27"	48" x 24"	120	800	60	5/8	189 lbs.	10542

All Cold Simulated Stone Shelf Built-In Flush Top models feature:

Electronic Temperature Control and a condensing unit, 6' cord and plug (NEMA 5-15P).

COLD SIMULATED STONE SHELVES BUILT-IN FLUSH TOP with UNATTACHED CONDENSER/CONTROL BOX

Model	Overall Shelf Dimensions (includes brackets) W x D	Shelf Space W x D	Voltage Single Phase	Watts	Hz	Comp. Size HP	Approx. Ship Weight	List Price
CSSBFR-24-F	27" x 18½"	24" x 15½"	120	300	60	1/5	120 lbs.	\$6739
CSSBFR-24-I	27" x 22½"	24" x 19½"	120	300	60	1/5	123 lbs.	6771
CSSBFR-24-S	27" x 27"	24" x 24"	120	300	60	1/5	150 lbs.	7017
CSSBFR-36-F	39" x 18½"	36" x 15½"	120	300	60	1/5	151 lbs.	7038
CSSBFR-36-I	39" x 22½"	36" x 19½"	120	450	60	1/3	151 lbs.	7071
CSSBFR-36-S	39" x 27"	36" x 24"	120	450	60	1/3	161 lbs.	8474
CSSBFR-48-F	51" x 18½"	48" x 15½"	120	450	60	1/3	158 lbs.	8107
CSSBFR-48-I	51" x 22½"	48" x 19½"	120	450	60	1/3	178 lbs.	8140
CSSBFR-48-S	51" x 27"	48" x 24"	120	800	60	5/8	166 lbs.	9695

All Cold Simulated Stone Shelf Built-In Flush Top with Unattached Condenser/Control Box models feature:

Models Shipped with: Shelf assembly with temperature probe, Control Box, condensing unit and TXV (all shipped loose).

OPTIONS – PAGE 127

Cold Simulated Stone Shelves Built-In Flush Top

continued...

- CSSBR models have unattached Condensing unit and Control Box, CSSBX models have unattached Control Box only
- CSSBFR, CSSBFX models have benefit of allowing fabricators the freedom to design



CSSBFX-48-S
in optional Gray Granite simulated stone – All models come with unattached Control Box only

COLD SIMULATED STONE SHELVES BUILT-IN FLUSH TOP with UNATTACHED CONTROL BOX only

Model	Overall Shelf Dimensions (includes brackets) W x D	Shelf Space W x D	Watts 120V Single Phase	Hz	Approx. Ship Weight	List Price
CSSBFX-24-F	27" x 18½"	24" x 15½"	12	60	78 lbs.	\$5665
CSSBFX-24-I	27" x 22½"	24" x 19½"	12	60	79 lbs.	5697
CSSBFX-24-S	27" x 27"	24" x 24"	12	60	89 lbs.	5943
CSSBFX-36-F	39" x 18½"	36" x 15½"	12	60	97 lbs.	5964
CSSBFX-36-I	39" x 22½"	36" x 19½"	12	60	115 lbs.	5997
CSSBFX-36-S	39" x 27"	36" x 24"	12	60	117 lbs.	7400
CSSBFX-48-F	51" x 18½"	48" x 15½"	12	60	116 lbs.	7033
CSSBFX-48-I	51" x 22½"	48" x 19½"	12	60	130 lbs.	7066
CSSBFX-48-S	51" x 27"	48" x 24"	12	60	144 lbs.	8621

All Cold Simulated Stone Shelf Built-In Flush Top with Unattached Control Box Only models feature:
Models Shipped with: Shelf assembly with temperature probe, solenoid valve (attached to shelf), Control Box (shipped loose) and TXV (unattached).

OPTIONS (available at time of purchase only)

Simulated stone colors – Non-standard colors are non-returnable – Night Sky standard –

SS-GGRAN	Gray Granite	No Charge
SS-BSAND	Bermuda Sand	No Charge
COND-8.5	102" cord (60" standard), CSSBF models only	\$ 14
EWC	Additional four year extended Parts Only Warranty on the compressor available at the time of unit purchase (CSSBF, CSSBFR models only)	200

COLORS AND FINISHES – INSIDE BACK COVER

COUNTERTOP CUTOUT DIMENSIONS

Model	Width with 3/8" radii	Height with 3/8" radii
CSSBF(R)(X)-24-F	24 3/8"	15 7/8"
CSSBF(R)(X)-24-I	24 3/8"	19 7/8"
CSSBF(R)(X)-24-S	24 3/8"	24 3/4"
CSSBF(R)(X)-36-F	36 3/8"	15 7/8"
CSSBF(R)(X)-36-I	36 3/8"	19 7/8"
CSSBF(R)(X)-36-S	36 3/8"	24 3/4"
CSSBF(R)(X)-48-F	48 3/8"	15 7/8"
CSSBF(R)(X)-48-I	48 3/8"	19 7/8"
CSSBF(R)(X)-48-S	48 3/8"	24 3/4"

Model	Width	Height
Control Box	9 1/2"	7 3/4"

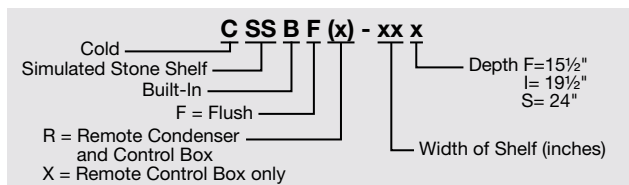



July 1, 2022

Cold Shelves Built-In Flush Top

Hatco's Cold Shelves Built-In Flush Top, in our signature Hardcoat Aluminum, are designed to keep your pre-chilled beverages, hors d'oeuvres, side dishes, buffet items and more, perfectly chilled.

- Patented thermal break reduces condensation and temperature transfer on adjacent surfaces
- All models are top mounted with an Hardcoat Aluminum surface
- All models match the GRSBF Heated Built-In Shelves for a fully integrated look
- Control Box comes standard with a 4' lead wire
- Control Box can be mounted 4' from center of the shelf (CSBF models only)
- CSBF models offer a long, flexible, refrigerant line which allows condensing unit to be pulled out for service
- Condensing unit features easy serviceability with sight glass, service valves, dryer/filter and receiver (CSBF, CSBFR models only)

continued on next page...



CSBF-48-S
(Flush Top)



CSBFR-48-S
(Flush Top) All models come with unattached Condenser and Control Box



COLD SHELVES BUILT-IN FLUSH TOP (Hardcoat Aluminum)

Model	Overall Shelf Dimensions W x D	Usable Shelf Space W x D	Voltage Single Phase	Watts	Comp. Size HP	Hz	Approx. Ship Weight	List Price
CSBF-24-F	25½" x 17"	24" x 15½"	120	300	1/5	60	108 lbs.	\$7301
CSBF-24-I	25½" x 21"	24" x 19½"	120	300	1/5	60	116 lbs.	7326
CSBF-24-S	25½" x 25½"	24" x 24"	120	300	1/5	60	117 lbs.	7429
CSBF-36-F	37½" x 17"	36" x 15½"	120	300	1/5	60	130 lbs.	7452
CSBF-36-I	37½" x 21"	36" x 19½"	120	450	1/3	60	130 lbs.	7484
CSBF-36-S	37½" x 25½"	36" x 24"	120	450	1/3	60	151 lbs.	8559
CSBF-48-F	49½" x 17"	48" x 15½"	120	450	1/3	60	138 lbs.	8378
CSBF-48-I	49½" x 21"	48" x 19½"	120	450	1/3	60	157 lbs.	8412
CSBF-48-S	49½" x 25½"	48" x 24"	120	800	5/8	60	177 lbs.	9316

All Cold Shelf Built-In Flush Top models feature:
Electronic Temperature Control and a condensing unit, 6' cord and plug (NEMA 5-15P).

COLD SHELVES BUILT-IN FLUSH TOP (Hardcoat Aluminum) with UNATTACHED CONDENSER/CONTROL BOX

Model	Overall Shelf Dimensions W x D	Usable Shelf Space W x D	Voltage Single Phase	Watts	Comp. Size HP	Hz	Approx. Ship Weight	List Price
CSBFR-24-F	25½" x 17"	24" x 15½"	120	300	1/5	60	102 lbs.	\$6623
CSBFR-24-I	25½" x 21"	24" x 19½"	120	300	1/5	60	116 lbs.	6648
CSBFR-24-S	25½" x 25½"	24" x 24"	120	300	1/5	60	126 lbs.	6751
CSBFR-36-F	37½" x 17"	36" x 15½"	120	300	1/5	60	127 lbs.	6774
CSBFR-36-I	37½" x 21"	36" x 19½"	120	450	1/3	60	128 lbs.	6806
CSBFR-36-S	37½" x 25½"	36" x 24"	120	450	1/3	60	139 lbs.	7881
CSBFR-48-F	49½" x 17"	48" x 15½"	120	450	1/3	60	145 lbs.	7700
CSBFR-48-I	49½" x 21"	48" x 19½"	120	450	1/3	60	147 lbs.	7734
CSBFR-48-S	49½" x 25½"	48" x 24"	120	800	5/8	60	166 lbs.	8638

All Cold Shelf Built-In Flush Top With Unattached Condenser/Control Box models feature:
Models Shipped with: Shelf assembly with temperature probe, Control Box, condensing unit and TXV (all shipped loose).

OPTIONS – PAGE 129

Cold Shelves Built-In Flush Top

continued...

- CSBFR models have unattached Condensing unit and Control Box, CSBFX models have unattached Control Box only
- CSBFR, CSBFX models have benefit of allowing fabricators the freedom to design



CSBFX-48-S
(Flush Top) All models come with unattached Control Box only

COLD SHELVES BUILT-IN FLUSH TOP (Hardcoat Aluminum) with UNATTACHED CONTROL BOX only

Model	Overall Shelf Dimensions W x D	Usable Shelf Space W x D	Watts 120V Single Phase	Approx. Ship Weight	List Price
CSBFX-24-F	25½" x 17"	24" x 15½"	12	63 lbs.	\$5380
CSBFX-24-I	25½" x 21"	24" x 19½"	12	71 lbs.	5405
CSBFX-24-S	25½" x 25½"	24" x 24"	12	79 lbs.	5508
CSBFX-36-F	37½" x 17"	36" x 15½"	12	68 lbs.	5531
CSBFX-36-I	37½" x 21"	36" x 19½"	12	90 lbs.	5563
CSBFX-36-S	37½" x 25½"	36" x 24"	12	100 lbs.	6638
CSBFX-48-F	49½" x 17"	48" x 15½"	12	117 lbs.	6457
CSBFX-48-I	49½" x 21"	48" x 19½"	12	117 lbs.	6491
CSBFX-48-S	49½" x 25½"	48" x 24"	12	130 lbs.	7395

All Cold Shelf Built-In Flush Top with Unattached Control Box Only models feature: Shelf assembly with temperature probe, solenoid valve (attached to shelf), Control Box (shipped loose) and TXV (unattached).

COUNTERTOP CUTOUT DIMENSIONS

Model	Width		Height	
	Min	Max	Min	Max
CSBF(R)(X)-24-F	24¾"	25"	16⅞"	16½"
CSBF(R)(X)-24-I	24¾"	25"	20⅞"	20½"
CSBF(R)(X)-24-S	24¾"	25"	24¾"	25"
CSBF(R)(X)-36-F	36¾"	37"	16⅞"	16½"
CSBF(R)(X)-36-I	36¾"	37"	20⅞"	20½"
CSBF(R)(X)-36-S	36¾"	37"	24¾"	25"
CSBF(R)(X)-48-F	48¾"	49"	16⅞"	16½"
CSBF(R)(X)-48-I	48¾"	49"	20⅞"	20½"
CSBF(R)(X)-48-S	48¾"	49"	24¾"	25"
Model	Width		Height	
Control Box	9½"		7¾"	

OPTIONS (available at time of purchase only)

COND-8.5	102" cord (60" standard), CSBF models only	\$ 14
EWC	Additional four year extended Parts Only Warranty on the compressor available at the time of unit purchase (CSBF, CSBFR models only)	200

COLORS AND FINISHES – INSIDE BACK COVER

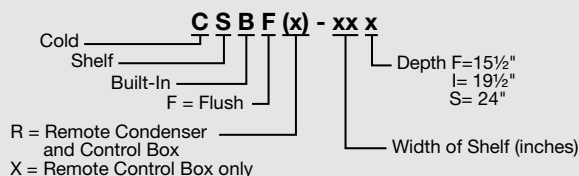



Cold Shelves Undermount

Cold Shelves Undermount provide a cold surface like the Cold Built-in Flush Top Shelves, but are mounted directly against the underside of a granite, quartz, Stainless Steel or appropriate solid surface countertop. Cooling transfers through the countertop with a seamless look.

- Mounts directly to underside of appropriate countertop material
- Approved materials include granite and quartz up to 1 3/16", Swanstone® (provided by Hatco), and certain Stainless Steel or aluminum surfaces approved by Hatco. Please contact the factory for applications with other material *
- All models feature an anodized aluminum surface
- Control Box comes standard with a 4' lead wire
- Control Box can be mounted 4' from center of the shelf (CSU models only)
- CSU models offer a long, flexible, refrigerant line which allows condensing unit to be pulled out for service
- Condensing unit features easy serviceability with sight glass, service valves, dryer/filter and receiver (CSU, CSUR models only)

continued on next page...



CSU-48-S
(Undermount)



CSUR-48-S
(Undermount)
All models include unattached Condenser and Control Box only



COLD SHELVES UNDERMOUNT (Anodized Aluminum)

Model*	Overall Shelf Dimensions (includes brackets) W x D	Usable Shelf Space W x D	Watts 120V Single Phase	Hz	Compressor Size HP	Approx. Ship Weight	List Price
CSU-24-F	27 5/16" x 18 13/16"	24" x 15 1/2"	300	60	1/5	118 lbs.	\$6868
CSU-24-I	27 5/16" x 22 13/16"	24" x 19 1/2"	300	60	1/5	115 lbs.	6899
CSU-24-S	27 5/16" x 27 13/16"	24" x 24"	300	60	1/5	130 lbs.	6968
CSU-36-F	39 5/16" x 18 13/16"	36" x 15 1/2"	300	60	1/5	143 lbs.	6857
CSU-36-I	39 5/16" x 22 13/16"	36" x 19 1/2"	450	60	1/3	140 lbs.	6869
CSU-36-S	39 5/16" x 27 13/16"	36" x 24"	450	60	1/3	125 lbs.	7813
CSU-48-F	51 5/16" x 18 13/16"	48" x 15 1/2"	450	60	1/3	141 lbs.	7618
CSU-48-I	51 5/16" x 22 13/16"	48" x 19 1/2"	450	60	1/3	144 lbs.	7650
CSU-48-S	51 5/16" x 27 13/16"	48" x 24"	800	60	5/8	178 lbs.	8329

All Cold Shelf Undermount models feature:

Models Shipped with: Electronic Temperature Control and a condensing unit, 6' cord and plug (NEMA 5-15P), thermal mastic caulk and single use applicator.

COLD UNDERMOUNT SHELVES with UNATTACHED CONDENSER/CONTROL BOX (Anodized Aluminum)

Model*	Overall Shelf Dimensions (includes brackets) W x D	Shelf Space W x D	Watts 120V Single Phase	Hz	Compressor Size HP	Approx. Ship Weight	List Price
CSUR-24-F	27 5/16" x 18 13/16"	24" x 15 1/2"	300	60	1/5	110 lbs.	\$6021
CSUR-24-I	27 5/16" x 22 13/16"	24" x 19 1/2"	300	60	1/5	110 lbs.	6052
CSUR-24-S	27 5/16" x 27 13/16"	24" x 24"	300	60	1/5	119 lbs.	6121
CSUR-36-F	39 5/16" x 18 13/16"	36" x 15 1/2"	300	60	1/5	119 lbs.	6010
CSUR-36-I	39 5/16" x 22 13/16"	36" x 19 1/2"	450	60	1/3	118 lbs.	6022
CSUR-36-S	39 5/16" x 27 13/16"	36" x 24"	450	60	1/3	143 lbs.	6966
CSUR-48-F	51 5/16" x 18 13/16"	48" x 15 1/2"	450	60	1/3	150 lbs.	6771
CSUR-48-I	51 5/16" x 22 13/16"	48" x 19 1/2"	450	60	1/3	150 lbs.	6803
CSUR-48-S	51 5/16" x 27 13/16"	48" x 24"	800	60	5/8	150 lbs.	7482



CSU and CSUR models include thermal mastic caulk and a single use applicator

All Cold Shelf Undermount with Unattached Condenser/Control Box models feature:

Models Shipped with: Shelf assembly with temperature probe, Control Box, condensing unit and TXV (all shipped loose), thermal mastic caulk and single use applicator.

* Make structural modifications or add bracing underneath the countertop to ensure countertop will support the weight of the unit and its contents. For mounting bolt and substrate cutout dimensions, please refer to the Installation section in the Operating Manual which is found on the Hatco website, www.hatcocorp.com.

OPTIONS – PAGE 131

Cold Shelves Undermount

continued...

- CSUR models have unattached Condensing unit and Control Box, CSUX models have unattached Control Box only
- CSUR and CSUX models have benefit of allowing fabricators the freedom to design.



CSUX-48-S
(Undermount) All models include unattached Control Box only

COLD SHELVES UNDERMOUNT (Anodized Aluminum) with UNATTACHED CONTROL BOX only

Model*	Overall Shelf Dimensions (includes brackets) W x D	Shelf Space W x D	Watts 120V Single Phase	Approx. Ship Weight	List Price
CSUX-24-F	27 ⁵ / ₁₆ " x 18 ¹³ / ₁₆ "	24" x 15 ¹ / ₂ "	12	73 lbs.	\$4947
CSUX-24-I	27 ⁵ / ₁₆ " x 22 ¹³ / ₁₆ "	24" x 19 ¹ / ₂ "	12	75 lbs.	4978
CSUX-24-S	27 ⁵ / ₁₆ " x 27 ¹³ / ₁₆ "	24" x 24"	12	84 lbs.	5047
CSUX-36-F	39 ⁵ / ₁₆ " x 18 ¹³ / ₁₆ "	36" x 15 ¹ / ₂ "	12	91 lbs.	4936
CSUX-36-I	39 ⁵ / ₁₆ " x 22 ¹³ / ₁₆ "	36" x 19 ¹ / ₂ "	12	95 lbs.	4948
CSUX-36-S	39 ⁵ / ₁₆ " x 27 ¹³ / ₁₆ "	36" x 24"	12	99 lbs.	5892
CSUX-48-F	51 ⁵ / ₁₆ " x 18 ¹³ / ₁₆ "	48" x 15 ¹ / ₂ "	12	102 lbs.	5697
CSUX-48-I	51 ⁵ / ₁₆ " x 22 ¹³ / ₁₆ "	48" x 19 ¹ / ₂ "	12	113 lbs.	5729
CSUX-48-S	51 ⁵ / ₁₆ " x 27 ¹³ / ₁₆ "	48" x 24"	12	124 lbs.	6408

CUTOUT DIMENSIONS

Model	Width	Height
Control Box	9 ¹ / ₂ "	7 ³ / ₄ "

All Cold Shelf Undermount with Unattached Control Box only models feature:

Models Shipped with: Shelf assembly with temperature probe, solenoid valve (attached to shelf), Control Box (shipped loose) and TXV (unattached).

* Make structural modifications or add bracing underneath the countertop to ensure countertop will support the weight of the unit and its contents. For mounting bolt and substrate cutout dimensions, please refer to the Installation section in the Operating Manual which is found on the Hatco website, www.hatcocorp.com.

OPTIONS (available at time of purchase only)

COND-8.5	102" conduit (60" standard), CSU models only	\$ 14
EWC	Additional four year extended Parts Only Warranty on the compressor available at the time of unit purchase (CSU, CSUR models only)	200

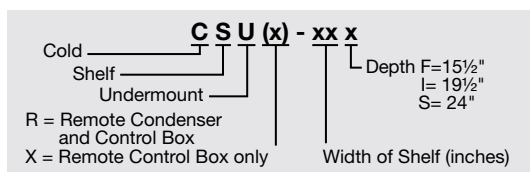



July 1, 2022

Hot/Cold Simulated Stone Shelves Built-In

Give your operation ultimate flexibility with Hatco's innovative, patented, Hot/Cold Simulated Stone Shelves Built-In. They easily transition between a heated to cold and cold to heated shelf!

- Patented thermal break reduces condensation and temperature transfer on adjacent surfaces
- Shelves change modes from hot to cold or vice versa in as little as 30 minutes, allowing quick change for different dayparts
- All models are bottom mount, flush with the countertop
- Simulated stone is Swanstone®
- All models match the GRSSB Heated Built-In Shelves
- Control Box with a 4' lead wire is standard
- Control Box can be mounted 4' from center of the shelf (HCSSB models only)
- HCSSB models offer a long, flexible, refrigerant line which allows condensing unit to be pulled out for service
- Condensing unit features easy serviceability with sight glass, service valves, dryer/filter and receiver (HCSSB, HCSSBR models only)
- HCSSBR has unattached Condensing unit and Control Box, HCSSBX has unattached Control Box only



HCSSB-4818
in optional
Bermuda Sand
simulated stone



HCSSBR-4818
in standard Night Sky simulated
stone – All models include
unattached Condenser and Control
Box only



HCSSBX-4818
in optional Gray Granite simulated
stone – All models include
unattached Control Box only

HOT/COLD SIMULATED STONE SHELVES BUILT-IN (flush to countertop)

Model	Overall Shelf Dimensions (includes brackets) W x D	Shelf Space W x D	Volts Single Phase	Cold Side Watts	Hot Side Watts	Hz	Comp. Size HP	Approx. Ship Weight	List Price
HCSSB-2418	27" x 21"	24" x 18"	120	300	405	60	1/5	133 lbs.	\$ 8846
HCSSB-3018	33" x 21"	30" x 18"	120	300	510	60	1/5	150 lbs.	8936
HCSSB-3618	39" x 21"	36" x 18"	120	300	610	60	1/5	160 lbs.	9099
HCSSB-4818	51" x 21"	48" x 18"	120	450	815	60	1/3	187 lbs.	10032

All Hot/Cold Simulated Stone Shelf Built-In models feature:
Electronic Temperature Control and a condensing unit, 6' cord and plug (NEMA 5-15P).

HOT/COLD SIMULATED STONE SHELVES BUILT-IN (flush to countertop) with UNATTACHED CONDENSER/CONTROL BOX

Model	Overall Shelf Dimensions (includes brackets) W x D	Shelf Space W x D	Volts Single Phase	Cold Side Watts	Hot Side Watts	Hz	Comp. Size HP	Approx. Ship Weight	List Price
HCSSBR-2418	27" x 21"	24" x 18"	120	300	405	60	1/5	115 lbs.	\$7999
HCSSBR-3018	33" x 21"	30" x 18"	120	300	510	60	1/5	151 lbs.	8089
HCSSBR-3618	39" x 21"	36" x 18"	120	300	610	60	1/5	162 lbs.	8252
HCSSBR-4818	51" x 21"	48" x 18"	120	450	815	60	1/3	187 lbs.	9185

All Hot/Cold Simulated Stone Shelf Built-In with Unattached Condenser/Control Box models feature:
Models Shipped with: Shelf assembly with temperature probe, Control Box, condensing unit and TXV (all shipped loose).

HOT/COLD SIMULATED STONE SHELVES BUILT-IN (flush to counter top) with UNATTACHED CONTROL BOX only

Model	Overall Shelf Dimensions (includes brackets) W x D	Shelf Space W x D	Watts 120V Single Phase	Approx. Ship Weight	List Price
HCSSBX-2418	27" x 21"	24" x 18"	405	75 lbs.	\$6925
HCSSBX-3018	33" x 21"	30" x 18"	510	105 lbs.	7015
HCSSBX-3618	39" x 21"	36" x 18"	610	117 lbs.	7178
HCSSBX-4818	51" x 21"	48" x 18"	815	140 lbs.	8111

All Hot/Cold Simulated Stone Shelf Built-In with unattached Control Box only models feature:

Models Shipped with: Shelf assembly with temperature probe, solenoid valve (attached to shelf), Control Box (shipped loose) and TXV (unattached).



COUNTERTOP CUTOUT DIMENSIONS

Model	Width with 3/8" radii	Height with 3/8" radii
HCSSB(R)(X)-2418	24 3/8"	18 3/8"
HCSSB(R)(X)-3018	30 3/8"	18 3/8"
HCSSB(R)(X)-3618	36 3/8"	18 3/8"
HCSSB(R)(X)-4818	48 3/8"	18 3/8"
Model	Width	Height
Control Box	14 5/8"	7 3/4"

OPTIONS

(available at time of purchase only)

Simulated stone colors –
Non-standard colors are non-returnable –
Night Sky standard –

SS-GGRAN Gray Granite **No Charge**
SS-BSAND Bermuda Sand **No Charge**

COND-8.5CC 102" conduit (7/2" standard), HCSSB models only **\$ 20**

EWC Additional four year extended Parts Only Warranty on the compressor available at the time of unit purchase (HCSSB, HCSSBR models only) **200**

COLORS AND FINISHES – INSIDE BACK COVER

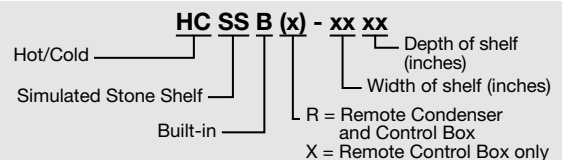

Hot/Cold Simulated Stone Shelves Built-In Flush Top

Give your operation ultimate flexibility with Hatco's innovative, patented Hot/Cold Simulated Stone Shelves Built-In Flush Top. They easily transition between a heated to cold and cold to heated shelf!

- Patented thermal break reduces condensation and temperature transfer on adjacent surfaces
- Shelves change modes from hot to cold or vice versa in as little as 30 minutes, allowing quick change for different dayparts
- All units are bottom mount, flush with the countertop
- Simulated stone is Swanstone®
- Control Box comes standard with a 4' lead wire
- Control Box can be mounted 4' from center of the shelf (HCSSBF models only)
- HCSSBF models offer a long, flexible, refrigerant line which allows condensing unit to be pulled out for service
- Condensing unit features easy serviceability with sight glass, service valves, dryer/filter and receiver (HCSSBF, HCSSBFR models only)

continued on next page...



HCSSBF-48-S
in standard Night Sky simulated stone



HCSSBFR-48-S
in optional Granite Gray simulated stone – All models include unattached Condenser and Control Box only

HOT/COLD SIMULATED STONE SHELVES BUILT-IN FLUSH TOP

Model	Overall Shelf Dimensions (includes brackets) W x D	Shelf Space W x D	Voltage Single Phase	Cold Side Watts	Hot Side Watts	Hz	Comp. Size HP	Approx. Ship Weight	List Price
HCSSBF-24-F	27" x 18½"	24" X 15½"	120	300	355	60	1/5	139 lbs.	\$ 8790
HCSSBF-24-I	27" x 22½"	24" X 19½"	120	300	445	60	1/5	134 lbs.	8846
HCSSBF-24-S	27" x 27"	24" X 24"	120	300	550	60	1/5	153 lbs.	8928
HCSSBF-36-F	39" x 18½"	36" X 15½"	120	300	530	60	1/5	164 lbs.	9065
HCSSBF-36-I	39" x 22½"	36" X 19½"	120	450	670	60	1/3	164 lbs.	9099
HCSSBF-36-S	39" x 27"	36" X 24"	120	450	825	60	1/3	180 lbs.	10169
HCSSBF-48-F	51" x 18½"	48" X 15½"	120	450	710	60	1/3	183 lbs.	9380
HCSSBF-48-I	51" x 22½"	48" X 19½"	120	450	890	60	1/3	195 lbs.	10088
HCSSBF-48-S	51" x 27"	48" X 24"	120	800	1100	60	5/8	243 lbs.	12150

All Hot/Cold Simulated Stone Shelf Built-In Flush Top models feature: Electronic Temperature Control and a condensing unit, 6' cord and plug (NEMA 5-15P).

HOT/COLD SIMULATED STONE SHELVES BUILT-IN FLUSH TOP with UNATTACHED CONDENSER/CONTROL BOX

Model	Overall Shelf Dimensions (includes brackets) W x D	Shelf Space W x D	Voltage Single Phase	Cold Side Watts	Hot Side Watts	Hz	Comp. Size HP	Approx. Ship Weight	List Price
HCSSBFR-24-F	27" x 18½"	24" X 15½"	120	300	355	60	1/5	118 lbs.	\$ 7943
HCSSBFR-24-I	27" x 22½"	24" X 19½"	120	300	445	60	1/5	123 lbs.	7999
HCSSBFR-24-S	27" x 27"	24" X 24"	120	300	550	60	1/5	107 lbs.	8081
HCSSBFR-36-F	39" x 18½"	36" X 15½"	120	300	530	60	1/5	159 lbs.	8218
HCSSBFR-36-I	39" x 22½"	36" X 19½"	120	450	670	60	1/3	159 lbs.	8252
HCSSBFR-36-S	39" x 27"	36" X 24"	120	450	825	60	1/3	190 lbs.	9322
HCSSBFR-48-F	51" x 18½"	48" X 15½"	120	450	710	60	1/3	187 lbs.	8533
HCSSBFR-48-I	51" x 22½"	48" X 19½"	120	450	890	60	1/3	206 lbs.	9241
HCSSBFR-48-S	51" x 27"	48" X 24"	120	800	1100	60	5/8	218 lbs.	11303

All Hot/Cold Simulated Stone Shelf Built-In Flush Top with Unattached Condenser/Control Box models feature: Models Shipped with: Shelf assembly with temperature probe, Control Box, condensing unit and TXV (all shipped loose).

OPTIONS – PAGE 134



July 1, 2022

Hot/Cold Simulated Stone Shelves Built-In Flush

continued...

- HCSSBFR has unattached Condensing unit and Control Box, HCSSBFX has unattached Control Box only
- HCSSBFR and HCSSBFX models have benefit of allowing fabricators the freedom to design



HCSSBFX-48-S
in optional Bermuda Sand simulated stone – All models include unattached Control Box only

HOT/COLD SIMULATED STONE SHELVES BUILT-IN FLUSH TOP with UNATTACHED CONTROL BOX only

Model	Overall Shelf Dimensions (includes brackets) W x D	Shelf Space W x D	Watts 120V Single Phase	Approx. Ship Weight	List Price
HCSSBFX-24-F	27" x 18½"	24" x 15½"	355	92 lbs.	\$ 6869
HCSSBFX-24-I	27" x 22½"	24" x 19½"	445	97 lbs.	6925
HCSSBFX-24-S	27" x 27"	24" x 24"	550	105 lbs.	7007
HCSSBFX-36-F	39" x 18½"	36" x 15½"	530	114 lbs.	7144
HCSSBFX-36-I	39" x 22½"	36" x 19½"	670	122 lbs.	7178
HCSSBFX-36-S	39" x 27"	36" x 24"	825	153 lbs.	8248
HCSSBFX-48-F	51" x 18½"	48" x 15½"	710	130 lbs.	7459
HCSSBFX-48-I	51" x 22½"	48" x 19½"	890	150 lbs.	8167
HCSSBFX-48-S	51" x 27"	48" x 24"	1100	167 lbs.	10229

All Hot/Cold Simulated Stone Shelf Built-In Flush Top with Unattached Control Box Only models feature:

Models Shipped with: Shelf assembly with temperature probe, solenoid valve (attached to shelf), Control Box (shipped loose) and TXV (unattached).

OPTIONS (available at time of purchase only)

Simulated stone colors – Non-standard colors are non-returnable –
Night Sky standard –

SS-GGRAN	Gray Granite	No Charge
SS-BSAND	Bermuda Sand	No Charge
COND-8.5CC	102" conduit (72" standard), HCSSBF models only	\$ 20
EWC	Additional four year extended Parts Only Warranty on the compressor available at the time of unit purchase (HCSSBF, HCSSBFR models only)	200

COLORS AND FINISHES – INSIDE BACK COVER

COUNTERTOP CUTOUT DIMENSIONS

Model	Width with 3/8" radii	Height with 3/8" radii
HCSSBF(R)(X)-24-F	24¾"	15⅞"
HCSSBF(R)(X)-24-I	24¾"	19⅞"
HCSSBF(R)(X)-24-S	24¾"	24¾"
HCSSBF(R)(X)-36-F	36¼"	15⅞"
HCSSBF(R)(X)-36-I	36¼"	19⅞"
HCSSBF(R)(X)-36-S	36¼"	24¾"
HCSSBF(R)(X)-48-F	48¼"	15⅞"
HCSSBF(R)(X)-48-I	48¼"	19⅞"
HCSSBF(R)(X)-48-S	48¼"	24¾"
Model	Width	Height
Control Box	14⅝"	7¾"

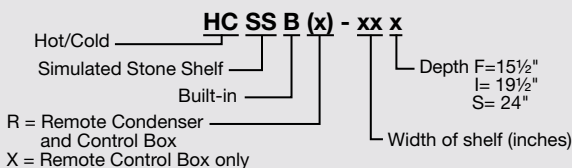

Hot/Cold Shelves Built-In Flush Top

Give your operation ultimate flexibility with Hatco's innovative, patented Hot/Cold Shelves Built-In Flush Top. In our signature Hardcoat Aluminum, they easily transition between a heated to cold and cold to heated shelf!

- Patented thermal break reduces condensation and temperature transfer on adjacent surfaces
 - Shelves change modes from hot to cold or vice versa in as little as 30 minutes, allowing quick change for different dayparts
 - Units are Hardcoat Aluminum, top mount
 - All models match the GRSBF Heated Built-In Shelves for a fully integrated look
 - Control Box with a 4' lead wire is standard
 - Control Box can be mounted 4' from center of the shelf (HCSBF models only)
 - HCSBF models offer a long, flexible, refrigerant line which allows condensing unit to be pulled out for service
 - Condensing unit features easy serviceability with sight glass, service valves, dryer/filter and receiver (HCSBF, HCSBFR models only)
- continued on next page...*



HCSBF-48-S



HCSBFR-48-S All models include unattached Condenser and Control Box only



HOT/COLD SHELVES BUILT-IN FLUSH TOP (Hardcoat Aluminum)

Model	Overall Shelf Dimensions W x D	Usable Shelf Space W x D	Voltage Single Phase	Cold Side Watts	Hot Side Watts	Hz	Comp. Size HP	Approx. Ship Weight	List Price
HCSBF-24-F	25½" x 17"	24" x 15½"	120	300	355	60	1/5	119 lbs.	\$ 8526
HCSBF-24-I	25½" x 21"	24" x 19½"	120	300	455	60	1/5	126 lbs.	8725
HCSBF-24-S	25½" x 25½"	24" x 24"	120	300	550	60	1/5	140 lbs.	8925
HCSBF-36-F	37½" x 17"	36" x 15½"	120	300	530	60	1/5	155 lbs.	8961
HCSBF-36-I	37½" x 21"	36" x 19½"	120	450	670	60	1/3	150 lbs.	9064
HCSBF-36-S	37½" x 25½"	36" x 24"	120	450	825	60	1/3	150 lbs.	9903
HCSBF-48-F	49½" x 17"	48" x 15½"	120	450	710	60	1/3	161 lbs.	9830
HCSBF-48-I	49½" x 21"	48" x 19½"	120	450	890	60	1/3	172 lbs.	10134
HCSBF-48-S	49½" x 25½"	48" x 24"	120	800	1100	60	5/8	204 lbs.	11065

All Hot/Cold Shelf Built-In Flush Top models feature:

Electronic Temperature Control and a condensing unit, 6' cord and plug (NEMA 5-15P).

HOT/COLD SHELVES BUILT-IN FLUSH TOP (Hardcoat Aluminum) with UNATTACHED CONDENSER/CONTROL BOX

Model	Overall Shelf Dimensions W x D	Usable Shelf Space W x D	Voltage Single Phase	Cold Side Watts	Hot Side Watts	Hz	Comp. Size HP	Approx. Ship Weight	List Price
HCSBFR-24-F	25½" x 17"	24" x 15½"	120	300	355	60	1/5	106 lbs.	\$ 7848
HCSBFR-24-I	25½" x 21"	24" x 19½"	120	300	455	60	1/5	118 lbs.	8047
HCSBFR-24-S	25½" x 25½"	24" x 24"	120	300	550	60	1/5	132 lbs.	8247
HCSBFR-36-F	37½" x 17"	36" x 15½"	120	300	530	60	1/5	147 lbs.	8283
HCSBFR-36-I	37½" x 21"	36" x 19½"	120	450	670	60	1/3	159 lbs.	8386
HCSBFR-36-S	37½" x 25½"	36" x 24"	120	450	825	60	1/3	156 lbs.	9225
HCSBFR-48-F	49½" x 17"	48" x 15½"	120	450	710	60	1/3	145 lbs.	9152
HCSBFR-48-I	49½" x 21"	48" x 19½"	120	450	890	60	1/3	131 lbs.	9456
HCSBFR-48-S	49½" x 25½"	48" x 24"	120	800	1100	60	5/8	255 lbs.	10387

All Hot/Cold Shelf Built-In Flush Top With Unattached Condenser/Control Box models feature:

Models Shipped with: Shelf assembly with temperature probe, Control Box, condensing unit and TXV (all shipped loose).

OPTIONS – PAGE 136



July 1, 2022

Hot/Cold Shelves Built-In Flush Top

continued...

- HCSBFR models have unattached Condensing unit and Control Box, HCSBFX models have unattached Control Box only
- HCSBFR and HCSBFX models have benefit of allowing fabricators the freedom to design.



HCSBFX-48-S
All models include unattached Control Box only

HOT/COLD SHELVES BUILT-IN FLUSH TOP (Hardcoat Aluminum) with UNATTACHED CONTROL BOX only

Model	Overall Shelf Dimensions W x D	Usable Shelf Space W x D	Rated Watts 120V Single Phase	Approx. Ship Weight	List Price
HCSBFX-24-F	25½" x 17"	24" x 15½"	355	74 lbs.	\$6605
HCSBFX-24-I	25½" x 21"	24" x 19½"	445	84 lbs.	6804
HCSBFX-24-S	25½" x 25½"	24" x 24"	550	95 lbs.	7004
HCSBFX-36-F	37½" x 17"	36" x 15½"	530	105 lbs.	7040
HCSBFX-36-I	37½" x 21"	36" x 19½"	670	114 lbs.	7143
HCSBFX-36-S	37½" x 25½"	36" x 24"	825	116 lbs.	7982
HCSBFX-48-F	49½" x 17"	48" x 15½"	710	120 lbs.	7909
HCSBFX-48-I	49½" x 21"	48" x 19½"	890	131 lbs.	8213
HCSBFX-48-S	49½" x 25½"	48" x 24"	1100	139 lbs.	9144

All Hot/Cold Shelf Built-In Flush Top with Unattached Control Box Only models feature:
Models Shipped with: Shelf assembly with temperature probe, solenoid valve (attached to shelf), Control Box (shipped loose) and TXV (unattached).

COUNTERTOP CUTOUT DIMENSIONS

Model	Width		Height	
	Min	Max	Min	Max
HCSBF(R)(X)-24-F	24 ⁵ / ₈ "	25"	16 ¹ / ₈ "	16½"
HCSBF(R)(X)-24-I	24 ⁵ / ₈ "	25"	20 ¹ / ₈ "	20½"
HCSBF(R)(X)-24-S	24 ⁵ / ₈ "	25"	24 ³ / ₄ "	25"
HCSBF(R)(X)-36-F	36 ⁵ / ₈ "	37"	16 ¹ / ₈ "	16½"
HCSBF(R)(X)-36-I	36 ⁵ / ₈ "	37"	20 ¹ / ₈ "	20½"
HCSBF(R)(X)-36-S	36 ⁵ / ₈ "	37"	24 ³ / ₄ "	25"
HCSBF(R)(X)-48-F	48 ⁵ / ₈ "	49"	16 ¹ / ₈ "	16½"
HCSBF(R)(X)-48-I	48 ⁵ / ₈ "	49"	20 ¹ / ₈ "	20½"
HCSBF(R)(X)-48-S	48 ⁵ / ₈ "	49"	24 ³ / ₄ "	25"
Model	Width		Height	
Control Box	14 ⁵ / ₈ "		7 ³ / ₄ "	

OPTIONS (available at time of purchase only)

COND-8.5CC	102" conduit (72" standard), HCSBF models only	\$ 20
EWC	Additional four year extended Parts Only Warranty on the compressor available at the time of unit purchase (HCSBF, HCSBFR models only)	200

COLORS AND FINISHES – INSIDE BACK COVER

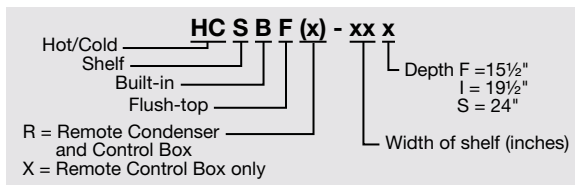

Glo-Ray® Rectangular Heated Simulated Stone Shelves Built-In

Match the heat zone to your countertops with these versatile shelves. These shelves are ideal for buffet lines or as hors d'oeuvre displays. These unique warmers will safely hold food hot while blending in with your décor.

- Shelves are made of approved foodsafe materials
- Features a lighted rocker switch and thermostatically-controlled heated base
- Includes Control Box with 3' conduit and 6' cord and plug
- Simulated stone is Swanstone®



GRSSB-3618 in optional Bermuda Sand built into a Bermuda Sand simulated stone countertop

NOTE: For any size GRSSB, the next larger size GRA or GR2A Strip Heater will fit over the top. For example, a GRSSB-3018 will require a GRA-36 or GR2A-36. The GRA will have a tight fit to the frame of the base. The GR2A will have approximately a 4" space.

Standard Control Box



Be sure to check out our Hot/Cold and Cold only Built-In Shelves for a seamless look

GLO-RAY RECTANGULAR HEATED SIMULATED STONE SHELVES BUILT-IN

Model [^]	Dimensions W x D x H	Voltage Single Phase	Watts	Plug	Ship Weight	List Price
GRSSB-2418	25 ⁵ / ₈ " x 19 ⁵ / ₈ " x 2 ¹ / ₄ "	120	635	NEMA 5-15P	30 lbs.	\$2139
GRSSB-3018	31 ⁵ / ₈ " x 19 ⁵ / ₈ " x 2 ¹ / ₄ "	120	780	NEMA 5-15P	43 lbs.	2226
GRSSB-3618	37 ⁵ / ₈ " x 19 ⁵ / ₈ " x 2 ¹ / ₄ "	120	930	NEMA 5-15P	48 lbs.	2320
GRSSB-4818	49 ⁵ / ₈ " x 19 ⁵ / ₈ " x 2 ¹ / ₄ "	120	1270	NEMA 5-15P	51 lbs.	2630
GRSSB-6018	61 ⁵ / ₈ " x 19 ⁵ / ₈ " x 2 ¹ / ₄ "	120	1560	NEMA 5-20P	56 lbs.	3451
GRSSB-7218	73 ⁵ / ₈ " x 19 ⁵ / ₈ " x 2 ¹ / ₄ "	120	1860	NEMA 5-20P	70 lbs.	3595

[^]Recommended for use in a metallic countertop. For other surfaces, verify that the material is suitable for temperatures up to 200°F. Hatco is not responsible for counter damage caused by heat from the warmer.

All Built-In Rectangular Heated Simulated Stone Shelf Built-In models feature:

Cord Location: Cord is attached to Control Box.

OPTIONS (available at time of purchase only)

Designer Color Bezel (Flush Mount Control Box, Bezel only) Stainless Steel standard – Non-standard colors are non-returnable –

RED	Warm Red	BLACK	Black	COPPER	Antique Copper	\$46
GRAY	Gray Granite	WHITE	White Granite			
NAVY	Navy Blue	GREEN	Hunter Green			

Simulated stone color – Non-standard colors are non-returnable – Night Sky standard – No Charge

SS-GGRAN	Gray Granite	SS-BSAND	Bermuda Sand			
SS-NSKY	Night Sky (standard)					
GRSSB-FLUSH-ITC	Flush Mount recessed Electronic Control Box with lighted On/Off rocker switch and angled recessed controls (6 ¹³ / ₃₂ "W x 7 ¹³ / ₁₆ "H x 4 ¹³ / ₁₆ "D)				\$196	
GRSSB-FLUSH-TSTAT	Flush Mount recessed Thermostatic Control Box with lighted On/Off rocker switch and angled recessed controls (6 ¹³ / ₃₂ "W x 7 ¹³ / ₁₆ "H x 4 ¹ / ₈ "D)				No Charge	
COND-6	6' Conduit (3' standard) – used with Flush Mount ITC Control Boxes only				\$45	
COND-10	10' Conduit (3' standard) – used with Flush Mount ITC Control Boxes only				86	
GRSSB-REC	Built-in Heated Simulated Stone Shelf with 1/2" Recessed Top (Increases total height of model to 2 3/4")				No Charge	



GRSSB-FLUSH-ITC



GRSSB-FLUSH-TSTAT

COLORS AND FINISHES – INSIDE BACK COVER

GRSSB, GRSB, GRSBF COUNTERTOP CUTOUT DIMENSIONS

Model	Minimum Width	Maximum Width	Minimum Depth	Maximum Depth
GRS(S)B(F)-2418	24 ⁵ / ₈ "	24 ⁵ / ₈ "	18 ⁵ / ₈ "	18 ⁵ / ₈ "
GRS(S)B(F)-3018	30 ⁵ / ₈ "	30 ⁵ / ₈ "	18 ⁵ / ₈ "	18 ⁵ / ₈ "
GRS(S)B(F)-3618	36 ⁵ / ₈ "	36 ⁵ / ₈ "	18 ⁵ / ₈ "	18 ⁵ / ₈ "
GRS(S)B(F)-4818	48 ⁵ / ₈ "	48 ⁵ / ₈ "	18 ⁵ / ₈ "	18 ⁵ / ₈ "
GRS(S)B(F)-6018	60 ⁵ / ₈ "	60 ⁵ / ₈ "	18 ⁵ / ₈ "	18 ⁵ / ₈ "
GRS(S)B(F)-7218	72 ⁵ / ₈ "	72 ⁵ / ₈ "	18 ⁵ / ₈ "	18 ⁵ / ₈ "

OPTIONAL GRSSB, GRSB, GRSBF CONTROL BOX CUTOUT DIMENSIONS

Model	Width	Height	Depth
GRS(S)B(F)-FLUSH-ITC	5 ⁷ / ₈ "	6 ³ / ₈ "	4 ³ / ₄ "
GRS(S)B(F)-FLUSH-TSTAT	5 ⁷ / ₈ "	6 ³ / ₈ "	4"





July 1, 2022

Rectangular Heated Base Glass Shelves Built-In

Hatco Heated Base Glass Shelves Built-In have a heated ceramic glass top to create uniform heat across the entire surface and are made of approved foodsafe materials. Adjustable thermostatic controls allow surface temperature to be controlled easily.

- Shelves are made of approved foodsafe materials
- Equipped with an attached Stainless Steel (standard) trim mounting ring (*Designer* Black or White available)

- Includes Control Box with 3' conduit and 6' cord and plug
- Lighted On/Off rocker switch



HBGB-2418 with optional *Designer* Black Trim Ring



HBGB-3618 with optional White Glass and Trim Ring

NOTE: For any size HBGB, the next larger size GRA or GR2A Strip Heater will fit over the top. For example, a HBGB-3018 will require a GRA-36 or GR2A-36. The GRA will have a tight fit to the frame of the base. The GR2A will have approximately a 4" space.

RECTANGULAR HEATED BASE GLASS SHELVES BUILT-IN

Model [^]	Dimensions (W x D x H)	Voltage (Single Phase)	Watts	Plug	Ship Weight	List Price
HBGB-2418	25 ³ / ₄ " x 19 ³ / ₄ " x 2 ¹ / ₄ "	120	425	NEMA 5-15P	32 lbs.	\$2899
HBGB-3018	31 ³ / ₄ " x 19 ³ / ₄ " x 2 ¹ / ₄ "	120	525	NEMA 5-15P	37 lbs.	3021
HBGB-3618	37 ³ / ₄ " x 19 ³ / ₄ " x 2 ¹ / ₄ "	120	630	NEMA 5-15P	40 lbs.	3150
HBGB-4818 ≈	49 ³ / ₄ " x 19 ³ / ₄ " x 2 ¹ / ₄ "	120	850	NEMA 5-15P	50 lbs.	3452
HBGB-6018 ≈	61 ³ / ₄ " x 19 ³ / ₄ " x 2 ¹ / ₄ "	120	1050	NEMA 5-15P	63 lbs.	3701
HBGB-7218 ≈	73 ³ / ₄ " x 19 ³ / ₄ " x 2 ¹ / ₄ "	120	1260	NEMA 5-15P	74 lbs.	3949

[^]Recommended for use in a metallic countertop. For other surfaces, verify that the material is suitable for temperatures up to 200°F. Hatco is not responsible for counter damage caused by heat from the warmer.

≈Units 48" and larger are constructed of two equal sized pieces of glass which create a seam.



Standard Control Box

All Rectangular Heated Base Glass Shelf Built-In models feature:

Cord Location: Cord is attached to Control Box.

OPTIONS (available at time of purchase only)

Ceramic Glass Color – Black standard – Non-standard colors are non-returnable		No Charge
HBGB-GLASS-WHT	White	
Bezel Color (Flush Mount Control Box, Bezel only) – Stainless Steel standard – Non-standard colors are non-returnable –		
HBGB-BESEL-BLACK	Black	\$ 46
HBGB-BESEL-WHITE	White	46
Trim Ring Color – Stainless Steel standard – Non-standard colors are non-returnable –		
HBGB-TRIM-BLK	<i>Designer</i> Black	46
HBGB-TRIM-WHITE	White	46
HBGB-FLUSH-ITC	Flush Mount recessed Electronic Control Box with lighted On/Off rocker switch and angled recessed controls (6 ¹³ / ₃₂ "W x 7 ¹³ / ₁₆ "H x 4 ¹³ / ₁₆ "D)	196
HBGB-FLUSH-TSTAT	Flush Mount recessed Thermostatic Control Box with lighted On/Off rocker switch and angled recessed controls (6 ¹³ / ₃₂ "W x 7 ¹³ / ₁₆ "H x 4 ¹ / ₈ "D)	No Charge
COND-6	6' Conduit (3' standard) – used with Flush Mount ITC Control Boxes only	\$44
COND-10	10' Conduit (3' standard) – used with Flush Mount ITC Control Boxes only	83
HBGB-REC	Built-In Heated Base Glass Shelf with Recessed Top	No Charge



HBGB-FLUSH-ITC



HBGB-FLUSH-TSTAT

HBGB COUNTERTOP CUTOUT DIMENSIONS

Model	Minimum Width	Maximum Width	Minimum Depth	Maximum Depth
HBGB-2418	24 ⁵ / ₈ "	24 ⁷ / ₈ "	18 ⁵ / ₈ "	18 ⁷ / ₈ "
HBGB-3018	30 ⁵ / ₈ "	30 ⁷ / ₈ "	18 ⁵ / ₈ "	18 ⁷ / ₈ "
HBGB-3618	36 ⁵ / ₈ "	36 ⁷ / ₈ "	18 ⁵ / ₈ "	18 ⁷ / ₈ "
HBGB-4818	48 ⁵ / ₈ "	48 ⁷ / ₈ "	18 ⁵ / ₈ "	18 ⁷ / ₈ "
HBGB-6018	60 ⁵ / ₈ "	60 ⁷ / ₈ "	18 ⁵ / ₈ "	18 ⁷ / ₈ "
HBGB-7218	72 ⁵ / ₈ "	72 ⁷ / ₈ "	18 ⁵ / ₈ "	18 ⁷ / ₈ "

OPTIONAL CONTROL BOX CUTOUT DIMENSIONS

Model	Width	Height	Depth
HBGB-FLUSH-ITC	5 ⁷ / ₈ "	6 ⁵ / ₈ "	4 ⁷ / ₈ "
HBGB-FLUSH-TSTAT	5 ⁷ / ₈ "	6 ⁵ / ₈ "	4"



Glo-Ray® Rectangular Heated Shelves Built-In with Recessed Top

Let Hatco add heat to your serving surface with the Glo-Ray Rectangular Heated Shelves Built-In with Recessed Top. This 1/2" recessed top foodwarmer has a Hardcoat Aluminum surface and blanket-type element for uniform heat to extend your food holding time.

- Uniform heat distribution with Hardcoat Aluminum surface and blanket-type element
- Includes Control Box with 3' conduit and 6' cord and plug
- Standard controller includes control thermostat, illuminated power switch and mounting brackets
- Thermostatically-controlled heated base
- For use in countertops up to 1/4" thick



GRSB-24-I



Standard Control Box

Be sure to check out our Hot/Cold and Cold only Built-In Shelves for a seamless look

NOTE: For any size GRSB, the next larger size GRA or GR2A Strip Heater will fit over the top. For example, a GRSB-30 will require a GRA-36 or GR2A-36. The GRA will have a tight fit to the frame of the base. The GR2A will have approximately a 4" space.

Quick-Ship Model pages 241-247

GLO-RAY RECTANGULAR HEATED SHELVES BUILT-IN with RECESSED TOP

Model [^]	Dimensions	Cut-Out Dimensions		Voltage		Watts	Ship Weight	List Price
	W x D x H	Min.-Max. Width	Min.-Max. Depth	Single Phase				
GRSB-24-F	25½" x 17" x 2⅞"	24½"-24¾"	16"-16¼"	120	420	25 lbs.	\$1787	
✓ GRSB-24-I	25½" x 21" x 2⅞"	24½"-24¾"	20"-20¼"	120	550	28 lbs.	1794	
GRSB-24-O	25½" x 31½" x 2⅞"	24½"-24¾"	30½"-30¾"	120	790	33 lbs.	1949	
GRSB-30-F	31½" x 17" x 2⅞"	30½"-30¾"	16"-16¼"	120	505	25 lbs.	1904	
✓ GRSB-30-I	31½" x 21" x 2⅞"	30½"-30¾"	20"-20¼"	120	665	29 lbs.	1912	
GRSB-30-O	31½" x 31½" x 2⅞"	30½"-30¾"	30½"-30¾"	120	950	37 lbs.	2121	
GRSB-36-F	37½" x 17" x 2⅞"	36½"-36¾"	16"-16¼"	120	590	28 lbs.	2024	
✓ GRSB-36-I	37½" x 21" x 2⅞"	36½"-36¾"	20"-20¼"	120	780	30 lbs.	2033	
GRSB-36-O	37½" x 31½" x 2⅞"	36½"-36¾"	30½"-30¾"	120	1110	37 lbs.	2362	
GRSB-42-F	43½" x 17" x 2⅞"	42½"-42¾"	16"-16¼"	120	685	30 lbs.	2124	
GRSB-42-I	43½" x 21" x 2⅞"	42½"-42¾"	20"-20¼"	120	885	37 lbs.	2135	
GRSB-42-O	43½" x 31½" x 2⅞"	42½"-42¾"	30½"-30¾"	120	1270	46 lbs.	2594	
GRSB-48-F	49½" x 17" x 2⅞"	48½"-48¾"	16"-16¼"	120	770	33 lbs.	2238	
✓ GRSB-48-I	49½" x 21" x 2⅞"	48½"-48¾"	20"-20¼"	120	1000	40 lbs.	2249	
GRSB-48-O	49½" x 31½" x 2⅞"	48½"-48¾"	30½"-30¾"	120	1430	68 lbs.	2795	
GRSB-54-I	55½" x 21" x 2⅞"	54½"-54¾"	20"-20¼"	120	1110	40 lbs.	2360	
GRSB-60-F	61½" x 17" x 2⅞"	60½"-60¾"	16"-16¼"	120	950	40 lbs.	2469	
GRSB-60-I	61½" x 21" x 2⅞"	60½"-60¾"	20"-20¼"	120	1220	43 lbs.	2480	
GRSB-60-O	61½" x 31½" x 2⅞"	60½"-60¾"	30½"-30¾"	120	1750	64 lbs.	3249	
GRSB-66-I	67½" x 21" x 2⅞"	66½"-66¾"	20"-20¼"	120	1330	49 lbs.	2572	
GRSB-72-F	73½" x 17" x 2⅞"	72½"-72¾"	16"-16¼"	120	1130	43 lbs.	2668	
GRSB-72-I	73½" x 21" x 2⅞"	72½"-72¾"	20"-20¼"	120	1440	50 lbs.	2680	
GRSB-72-O	73½" x 31½" x 2⅞"	72½"-72¾"	30½"-30¾"	208, 240	2070	68 lbs.	3706	

[^] Recommended for use in a metallic countertop. For other surfaces, verify that the material is suitable for temperatures up to 200°F. Hatco is not responsible for counter damage caused by heat from the warmer.

All Glo-Ray Rectangular Heated Shelf Built-In with Recessed Top models feature:

Plugs: All models ending in -F and -I and models 24" through 48" wide ending in -O: NEMA 5-15P.

GRSB-60-O: NEMA 5-20P.

GRSB-72-O: NEMA 6-15P.

Usable Heated Shelf Space: Subtract 1½" from both width and depth of unit.

Cord Location: Cord is attached to Control Box.

OPTIONS AND ACCESSORIES – PAGE 140

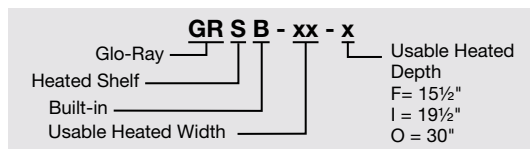



July 1, 2022



A **GRSB-54-I** Heated Shelf below a **GRAL-96D** Strip Heater

OPTIONS (available at time of purchase only – not available on Quick-Ship)

Designer Color Bezel (Flush Mount Control Box, Bezel only) – Stainless Steel standard		
Non-standard colors are non-returnable –		\$ 46
RED	Warm Red	
WHITE	White Granite	
COPPER	Antique Copper	
BLACK	Black	
NAVY	Navy Blue	
GRAY	Gray Granite	
GREEN	Hunter Green	
GRSB-FLUSH-ITC	Flush Mount recessed Electronic Control Box with lighted On/Off rocker switch and angled recessed controls (6 ¹³ / ₃₂ "W x 7 ¹³ / ₁₆ "H x 4 ¹³ / ₁₆ "D)	194
GRSB-FLUSH-TSTAT	Flush Mount recessed Thermostatic Control Box with lighted On/Off rocker switch and angled recessed controls (6 ¹³ / ₃₂ "W x 7 ¹³ / ₁₆ "H x 4 ¹ / ₈ "D)▼	No Charge
COND-6	6' Conduit (3' standard) – used with Flush Mount ITC Control Boxes only	\$44
COND-10	10' Conduit (3' standard) – used with Flush Mount ITC Control Boxes only	83

ACCESSORIES (available for purchase at any time)

Stainless Steel Channel Dividers for GRSB models – Required to keep Rods in place – includes front and back Dividers –

GRSB-CD-24	For GRSB-24 models	\$ 58
GRSB-CD-30	For GRSB-30 models	77
GRSB-CD-36	For GRSB-36 models	97
GRSB-CD-42	For GRSB-42 models	114
GRSB-CD-48	For GRSB-48 models	135
GRSB-CD-54	For GRSB-54 models	154
GRSB-CD-60	For GRSB-60 models	173
GRSB-CD-66	For GRSB-66 models	193
GRSB-CD-72	For GRSB-72 models	213

Stainless Steel Rods – sold individually –

GRSB-DIV-F	For F depth units	each \$26
GRSB-DIV-I	For I depth units	each 28
GRSB-DIV-O	For O depth units	each 33

▼ See page 137 for Control Box cutout dimensions

FOOD PANS AND TRIVETS – PAGE 240
COLORS AND FINISHES – INSIDE BACK COVER

GRSB-72-I with Channel Dividers (vertical, with notches) and Rods (horizontal)



GRSB-FLUSH-ITC



GRSB-FLUSH-TSTAT

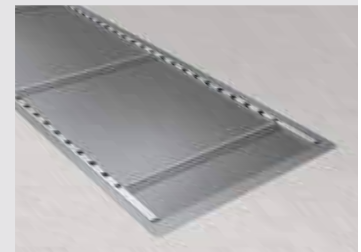

Glo-Ray® Rectangular Heated Shelves Built-In with Flush Top

Add heat to your serving surface with the Glo-Ray Rectangular Heated Shelf Built-In with Flush Top. The Hardcoat Aluminum surface and blanket-type element provides uniform heat to extend your food holding time.

- Uniform heat distribution with Hardcoat Aluminum surface and blanket-type element
- Includes Control Box with 3' conduit and 6' cord and plug
- Thermostatically-controlled heated base
- Standard controller includes control thermostat, illuminated power switch and mounting brackets
- Model widths from 25½" to 73½"
- Optional Stainless Steel surface
- For use in countertops up to 1¼" thick



GRSBF-60-0 built into a Bermuda Sand simulated stone countertop with accessory pans, shown below a **GR2AL-96D** Strip Heater in *Designer Black* with optional Sneeze Guards

Quick-Ship Model pages 241-247

GLO-RAY RECTANGULAR HEATED SHELVES BUILT-IN with FLUSH TOP

Model [^]	Dimensions W x D x H	Cut-Out Dimensions		Voltage Single Phase	Watts	Ship Weight	List Price
		Min.-Max. Width	Min.-Max. Depth				
GRSBF-24-F	25½" x 17" x 2¼"	24½"-24¾"	16"-16¼"	120	420	28 lbs.	\$1787
✓ GRSBF-24-I	25½" x 21" x 2¼"	24½"-24¾"	20"-20¼"	120	550	27 lbs.	1794
GRSBF-24-S	25½" x 25½" x 2¼"	24½"-24¾"	24½"-24¾"	120	680	32 lbs.	1901
GRSBF-24-O	25½" x 31½" x 2¼"	24½"-24¾"	30½"-30¾"	120	790	35 lbs.	1949
GRSBF-30-F	31½" x 17" x 2¼"	30½"-30¾"	16"-16¼"	120	505	24 lbs.	1904
✓ GRSBF-30-I	31½" x 21" x 2¼"	30½"-30¾"	20"-20¼"	120	665	30 lbs.	1912
GRSBF-30-S	31½" x 25½" x 2¼"	30½"-30¾"	24½"-24¾"	120	815	33 lbs.	2059
GRSBF-30-O	31½" x 31½" x 2¼"	30½"-30¾"	30½"-30¾"	120	950	37 lbs.	2121
GRSBF-36-F	37½" x 17" x 2¼"	36½"-36¾"	16"-16¼"	120	590	32 lbs.	2024
✓ GRSBF-36-I	37½" x 21" x 2¼"	36½"-36¾"	20"-20¼"	120	780	30 lbs.	2033
GRSBF-36-S	37½" x 25½" x 2¼"	36½"-36¾"	24½"-24¾"	120	950	35 lbs.	2292
GRSBF-36-O	37½" x 31½" x 2¼"	36½"-36¾"	30½"-30¾"	120	1110	37 lbs.	2362
GRSBF-42-F	43½" x 17" x 2¼"	42½"-42¾"	16"-16¼"	120	685	38 lbs.	2124
GRSBF-42-I	43½" x 21" x 2¼"	42½"-42¾"	20"-20¼"	120	885	32 lbs.	2135
GRSBF-42-S	43½" x 25½" x 2¼"	42½"-42¾"	24½"-24¾"	120	1090	40 lbs.	2511
GRSBF-42-O	43½" x 31½" x 2¼"	42½"-42¾"	30½"-30¾"	120	1270	48 lbs.	2594
GRSBF-48-F	49½" x 17" x 2¼"	48½"-48¾"	16"-16¼"	120	770	35 lbs.	2238
✓ GRSBF-48-I	49½" x 21" x 2¼"	48½"-48¾"	20"-20¼"	120	1000	40 lbs.	2249
GRSBF-48-S	49½" x 25½" x 2¼"	48½"-48¾"	24½"-24¾"	120	1225	42 lbs.	2701
GRSBF-48-O	49½" x 31½" x 2¼"	48½"-48¾"	30½"-30¾"	120	1430	48 lbs.	2795
GRSBF-54-I	55½" x 21" x 2¼"	54½"-54¾"	20"-20¼"	120	1110	41 lbs.	2362
GRSBF-60-F	61½" x 17" x 2¼"	60½"-60¾"	16"-16¼"	120	950	41 lbs.	2469
GRSBF-60-I	61½" x 21" x 2¼"	60½"-60¾"	20"-20¼"	120	1220	48 lbs.	2480
GRSBF-60-S	61½" x 25½" x 2¼"	60½"-60¾"	24½"-24¾"	120	1500	55 lbs.	3160
GRSBF-60-O	61½" x 31½" x 2¼"	60½"-60¾"	30½"-30¾"	120	1750	64 lbs.	3249
GRSBF-66-I	67½" x 21" x 2¼"	66½"-66¾"	20"-20¼"	120	1330	49 lbs.	2579
GRSBF-72-F	73½" x 17" x 2¼"	72½"-72¾"	16"-16¼"	120	1130	44 lbs.	2668
GRSBF-72-I	73½" x 21" x 2¼"	72½"-72¾"	20"-20¼"	120	1440	52 lbs.	2680
GRSBF-72-S	73½" x 25½" x 2¼"	72½"-72¾"	24½"-24¾"	120	1750	59 lbs.	3560
GRSBF-72-O	73½" x 31½" x 2¼"	72½"-72¾"	30½"-30¾"	208, 240	2070	68 lbs.	3706

[^]Recommended for use in a metallic countertop. For other surfaces, verify the material is suitable for temperatures up to 200°F. Hatco is not responsible for counter damage caused by heat from the warmer.

All Glo-Ray Rectangular Heated Shelf Built-In with Flush Top models feature:

Plugs: All models ending in -F and -I and models 24" through 48" wide ending in -S and -O: NEMA 5-15P.

GRSBF-60-S, GRSBF-60-O and GRSBF-72-S: NEMA 5-20P. GRSBF-72-O: NEMA 6-15P.

Usable Heated Shelf Space: Width of unit minus 1½" x depth of unit minus 1½". **Cord Location:** Cord is attached to Control Box.



Standard Control Box

NOTE: For any size GRSBF, the next larger size GRA or GR2A Strip Heater will fit over the top. For example, a GRSBF-30 will require a GRA-36 or GR2A-36. The GRA will have a tight fit to the frame of the base. The GR2A will have approx a 4" space.



GRSBF-FLUSH-ITC



GRSBF-FLUSH-TSTAT

OPTIONS (available at time of purchase only – not available on Quick-Ship)

Designer Color Bezel (Flush Mount Control Box, Bezel only) – Stainless Steel standard – Non-standard colors are non-returnable –

\$46

RED Warm Red **WHITE** White Granite **BLACK** Black **NAVY** Navy Blue

GRAY Gray Granite **GREEN** Hunter Green **COPPER** Antique Copper

Stainless Steel surface in lieu of Hardcoat Aluminum (GRSBF models only)

No Charge

GRSBF-FLUSH-ITC Flush Mount recessed Electronic Control Box with lighted On/Off rocker switch and angled recessed controls (6¹³/₃₂"W x 7¹³/₁₆"H x 4¹³/₁₆"D) ▼ **\$194**

GRSBF-FLUSH-TSTAT Flush Mount recessed Thermostatic Control Box with lighted On/Off rocker switch and angled recessed controls (6¹³/₃₂"W x 7¹³/₁₆"H x 4¹³/₁₆"D) ▼ **No Charge**

COND-6 6' Conduit (3' standard) – used with Flush Mount ITC Control Boxes only **\$44**

COND-10 10' Conduit (3' standard) – used with Flush Mount ITC Control Boxes only **83**

▼ See page 137 for Control Box cutout dimensions

FOOD PANS AND TRIVETS – PAGE 240

COLORS AND FINISHES – INSIDE BACK COVER

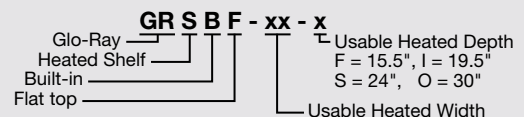

Drawer Warmers

*Cafeterias • Convenience Stores
Restaurants & Cafés • Clubs & Bars • Concessions*



HDWTC-2 pg. 143



HDW-2 with 6" deep food pans pg. 144



HDW-2B in optional *Designer Warm Red* pg. 144



HDW-1.5R2 with optional touchscreen control
pg. 144



CDW-3N pg. 146



HRDW-2U-1 with standard utensil well and
utensil pan (lid and pot not included) pg. 147

Heated Drawer Warmers with Top Control

Hatco Drawer Warmers ensure optimal holding of a variety of products at safe temperatures, while minimizing moisture loss and texture change. Our unique blanket element design promotes uniform temperatures throughout the cavity. Each drawer features adjustable sliding vents. Touchscreen controller controls temperature and time for each drawer individually.

- Top-of-the-unit touchscreen controller is positioned at an angle for greater visibility
- Controller provides individual temperature control and hold timer for each drawer with visual and audio alerts
- Robust stainless steel construction inside and out
- Drawer frame is constructed of heavy duty, 12 gauge stainless steel and drawers slide on durable nylon rollers
- Easy-to-clean seamless interior core
- Snap out side panels make this unit easy to clean and service
- Drawer frame can accommodate varying pan configurations, including full size, half size or one-third size pans up to 6" deep, with or without lids
- Pans lift straight up, eliminating the need to tilt pan for removal
- USB port for easy software updates
- Unit comes standard with 4" plastic legs



HDWTC-2
shown with Accessory 2" casters
(4" plastic legs are standard)

HEATED DRAWER WARMERS WITH TOP CONTROL

Model	Dimensions [†]			Voltage	Watts	Plug	Approximate Ship Weight	List Price
	W x D x H							
HDWTC-1	24 ¹ / ₂ "	25 ⁵ / ₈ "	11 ¹¹ / ₁₆ "	120	353	NEMA 5-15P	120 lbs	\$4370
HDWTC-2	24 ¹ / ₂ "	25 ⁵ / ₈ "	20 ¹ / ₈ "	120	704	NEMA 5-15P	178 lbs	6342
HDWTC-3	24 ¹ / ₂ "	25 ⁵ / ₈ "	28 ⁷ / ₁₆ "	120	1055	NEMA 5-15P	217 lbs	8325

[†] Add 1³/₈" to depth for drawer handle. Height does not include standard 4" plastic legs.

All Heated Drawer Warmers with Top Control models feature:

Models Shipped with: One 6" deep food pan per drawer, 4" plastic legs, 6' cord and plug.
Cord Location: top, back-left side, recessed to protect plug.

OPTIONS (available at time of purchase only)

OS-PAN	Oversized Drawer Frame and Pan (20" x 15" x 5") in lieu of standard Drawer with Pan	per drawer \$153
---------------	---	-------------------------

ACCESSORIES (available for purchase at any time)

HDW-TRIVET	Custom trivet raises food product 1/2" off bottom of full size pan (17 1/2" x 9 1/2" x 1/2")	\$ 67
HDW 6" LEG	6" adjustable stainless steel Legs	209
HDW-CASTER-2	2" Dia. Casters – all swivel, 2 lock – adds 2 1/2" to height of unit	256
HDW-CASTER-3	3" Dia. Locking Casters – all swivel, all lock – adds 4 1/4" to height of unit	256
HDW-CASTER-5	5" Dia. Locking Casters – all swivel, all lock – adds 6 1/4" to height of unit	307

FOOD PANS AND TRIVETS – PAGE 240

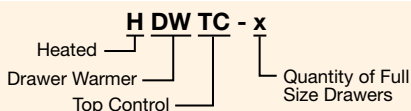

Drawer Warmers

Hold everything from meat to vegetables to rolls in the Hatco Drawer Warmers. Built for tough kitchen duty with rugged construction and heavy-duty hardware, these warmers keep a variety of foods hot and fresh until served.

- Standard and narrow widths
- 1-, 2-, 3- or 4-drawer freestanding or 1-, 2- or 3-drawer built-in models
- Completely insulated individual cavities provide maximum energy efficiency (excludes HDW-1R2, -2R2)
- Each drawer has a food pan, recessed individual thermostatic control, temperature monitor, vent slides and power switch
- 12-gauge stainless steel heavy-duty drawer slides with nylon rollers
- Available with: oversized drawer frame, biscuit pan drawer, chip guard, casters, 6" adjustable stainless steel legs, water/spillage pan and splash baffle
- Standard width Drawer Warmer pans lift straight out of drawer (HDW-1N, -2N, -3N and HDW-1R2, -1.5R2, -2R2 models requiring tipping the pan to install)



Quick-Ship Model pages 241-247

FREESTANDING DRAWER WARMERS

Model	Dimensions* W x D x H	Voltage Single Phase	Watts	Ship Weight	List Price
✓ HDW-1	29½" x 22¾" x 11"	120, 208, 240	450	97 lbs.	\$2870
✓ HDW-2	29½" x 22¾" x 21½"	120, 208, 240	900	168 lbs.	4872
✓ HDW-3	29½" x 22¾" x 31¼"	120, 208, 240	1350	232 lbs.	6879
HDW-4 ^S	29½" x 22¾" x 41¾"	120, 208, 240	1800	296 lbs.	9080
HDW-1N	20¾" x 27" x 11"	120, 208, 240	450	83 lbs.	2870
HDW-2N	20¾" x 27" x 21½"	120, 208, 240	900	168 lbs.	4872
HDW-3N	20¾" x 27" x 31¼"	120, 208, 240	1350	223 lbs.	6879

* Add 1½" to depth for drawer handle. Height does not include standard 4" plastic legs.
^S Not available for Canada.

All Freestanding Drawer Warmer models feature:

Plug: NEMA 5-15P. (208 and 240V use NEMA 6-15P).
 HDW-4 Shipped with: 6" stainless steel legs.
 Models Shipped with: One 6" deep food pan per drawer, 4" plastic legs, 6' cord and plug.
 Cord Location: Back of unit, lower left corner.

SPLIT DRAWER WARMERS

Model	Dimensions* W x D x H	Voltage Single Phase	Watts	Ship Weight	List Price
HDW-1R2	28¾" x 16¾" x 10¾"	120	690	90 lbs.	\$4190
HDW-1.5R2	28¾" x 16½" x 15½"	120	990	112 lbs.	5949
HDW-2R2	28¾" x 16¾" x 20"	120	1290	135 lbs.	6530

* Add 1½" to depth for drawer handle. Height does not include standard 4" plastic legs.

All Split Drawer Warmer models feature:

Plug: NEMA 5-15P.
 HDW-1R2 shipped with: Two 2½" deep food pans, 4" legs, 6' cord and plug.
 HDW-1.5R2 shipped with: Three 2½" deep food pans, 4" legs, 6' cord and plug.
 HDW-2R2 shipped with: Four 2½" deep food pans, 4" legs, 6' cord and plug.
 Pan Capacity: 20¾"W x 12¾"D x 2½"H.
 Cord Location: Back of unit, lower left corner.

Quick-Ship Model pages 241-247

BUILT-IN DRAWER WARMERS

Model	Dimensions* W x D x H	Voltage Single Phase	Watts	Ship Weight	List Price
HDW-1B	28¼" x 22¾" x 9¾"	120, 208, 240	450	88 lbs.	\$2761
✓ HDW-2B	28¼" x 22¾" x 20"	120, 208, 240	900	159 lbs.	4667
HDW-3B	28¼" x 22¾" x 30½"	120, 208, 240	1350	232 lbs.	6571
HDW-1BN	19½" x 26¾" x 9¾"	120, 208, 240	450	88 lbs.	2761
HDW-2BN	19½" x 26¾" x 20"	120, 208, 240	900	159 lbs.	4667
HDW-3BN	19½" x 26¾" x 30½"	120, 208, 240	1350	232 lbs.	6571

* Add 1½" to depth for drawer handle. Width and Height excludes front mounting flange.

All Built-In Drawer Warmer models feature:

Conduit: 4' flexible conduit.
 Models Shipped with: One 6" deep food pan per drawer.

BUILT-IN CUTOUT REQUIREMENTS

Model	Width	Depth*	Height
HDW-1B	28¾"	24"	10½"
HDW-2B	28¾"	24"	20¼"
HDW-3B	28¾"	24"	30¾"
HDW-1BN	19¾"	28¾"	10½"
HDW-2BN	19¾"	28¾"	20¼"
HDW-3BN	19¾"	28¾"	30¾"

* Depth includes 1½" for conduit connector.

OPTIONS AND ACCESSORIES – PAGE 145

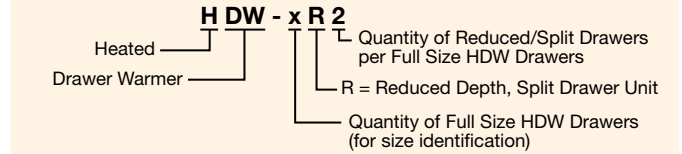
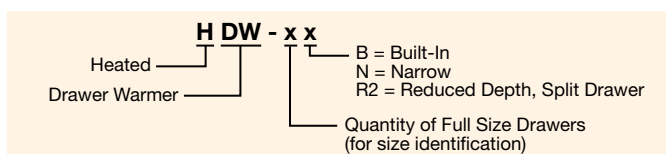

OPTIONS (available at time of purchase only - not available on Quick-Ship)

Designer Drawer Front colors per drawer (not available for HDW-1R2, -1.5R2, -2R2 models)
Non-standard colors are non-returnable – Stainless steel standard

RED	Warm Red	\$75
BLACK	Black	75
GRAY	Gray Granite	75
WHITE	White Granite	75
NAVY	Navy Blue	75
GREEN	Hunter Green	75
COPPER	Antique Copper	75
HDW-TTC	Temperature Control Timer – 6-channel control touchscreen display	\$672
OS-PAN	Oversized Drawer Frame and Pan (20" x 15" x 5") in lieu of standard Drawer with Pan, standard width models only (excludes HDW-1R2, -1.5R2, -2R2)	per drawer 153
BIS DRAWER	Biscuit Pan Drawer – accommodates two 18" x 13" Half-Size Sheet Pans (not included) in lieu of standard Drawer with Pan, standard width models only (excludes HDW-1R2, -1.5R2, -2R2)	No Charge
HDW-CHIP	Chip Guard (excludes HDW-1R2, -1.5R2, -2R2)	per drawer 50
RD-NOVENT	No Drawer Vents (HDW-1R2, -1.5R2, -2R2 only)	No Charge

ACCESSORIES (available for purchase at any time)

HDW-TRIVET	Custom trivet raises food product 1/2" off bottom of full size pan 17 1/2" x 9 1/2" x 1 1/2"	\$ 67
HDW 6" LEG	6" Adjustable Stainless Steel Legs, standard on HDW-4 (excludes HDW-1R2, -1.5R2, -2R2)	209
HDW-CASTER-2	2" Dia. Casters – all swivel, 2 lock – adds 2 1/2" to height of unit, HDW-1, -2, -3 models only (excludes HDW-1R2, -1.5R2, -2R2)	256
HDW-CASTER-3	3" Dia. Locking Casters – all swivel, all lock – adds 4 1/4" to height of unit, HDW-1, -2, -3 models only (excludes HDW-1R2, -1.5R2, -2R2)	256
HDW-CASTER-5	5" Dia. Locking Casters – all swivel, all lock – adds 6 1/4" to height of unit (excludes HDW-1R2, -1.5R2, -2R2)	307
HDW-SPILL	Water/Spillage Pan – one per drawer (excludes HDW-1R2, -1.5R2, -2R2 and BIS Drawer, and OS-Pan Options)	291
HDW-SPLASH	Splash Baffle – one per drawer (excludes HDW-1R2, -1.5R2, -2R2 and BIS Drawer, and OS-Pan Options)	61

FOOD PANS AND TRIVETS – PAGE 240
COLORS AND FINISHES – INSIDE BACK COVER

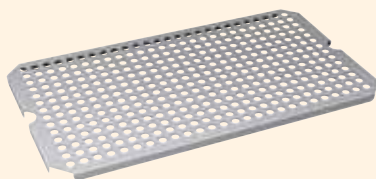

HDW-TRIVET



CASTERS
HDW-CASTER-2 all swivel, 2 lock
HDW-CASTER-3 all swivel, all lock
HDW-CASTER-5 all swivel, all lock



HDW 6" LEG

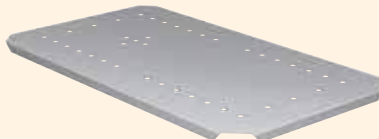

HDW-SPLASH



HDW-TTC Option
 Shown: Temperature adjustment and timer touchscreen control



Biscuit Pan Drawer (pans not included)
BIS DRAWER Option

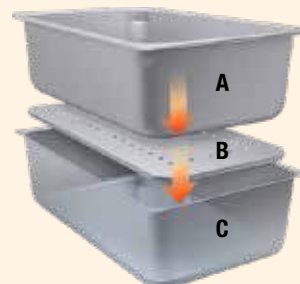

Additional Humidity
 A. Stainless Steel Food Pan
 B. Splash Baffle
HDW-SPLASH accessory
 C. Water/Spillage Pan (add 1/4" of water)
HDW-SPILL accessory

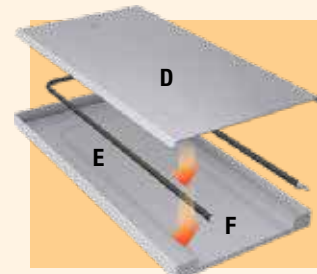

Prevents chips from reaching the element
 D. Heat Shield (included)
 E. Heating Element (included)
 F. Chip Guard **HDW-CHIP** Option (Standard width shown)



Convected Drawer Warmer

This drawer warmer is designed to keep a variety of food products hot and flavor-fresh until served. With a single non-humidified cavity and a single electronic temperature control, this unit provides even, dry heat for food products that do not require humidity. With insulated top, sides and back, they provide excellent energy efficiency.

- Digital electronic controller for easy programming
- Low velocity convected air system provides even temperature throughout the cabinet
- Tough, durable chrome handles that are angled to avoid contact from passing carts
- Narrow width fits most kitchen footprints
- Heavy-duty drawer slides with nylon rollers
- Includes three full-size pans
- Provides even, dry heat for food products that do not require humidity.



CDW-3N

CONVECTED DRAWER WARMER

Model	Dimensions [†] W x D x H	Voltage Single Phase	Watts	Ship Weight	List Price
CDW-3N	16 ⁵ / ₈ " x 28 ³ / ₃₂ " x 27 ¹ / ₂ "	120	1015	179 lbs.	\$5665

[†] Add 1³/₈" to depth for drawer handle. Height does not include casters, which add 2¹/₂" to height.

All Convected Drawer Warmer models feature:

Plug: NEMA 5-15P.

Models Shipped with: One 6" deep food pan per drawer, low profile 2" diameter casters, 6' cord and plug.

Cord Location: Back of unit, top right corner.

FOOD PANS AND TRIVETS – PAGE 240

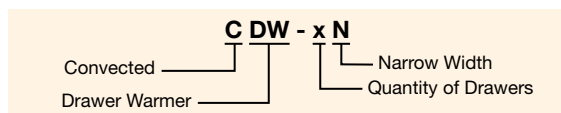

Heated Rice Drawer Warmers

Hatco's Heated Rice Drawer Warmers are designed to keep rice hot and at desired consistency until served.

It holds rice in the same pot it's prepared in, reducing pan-to-pan transfer time and labor.

With a digital electronic temperature control, this unit provides even heat throughout the holding cavity.

With all around insulation, these drawer warmers provide excellent energy efficiency.

- Drawers accept Panasonic 23 cup rice pots (pots and lids not available)
- Drawers accept Town 30 cup rice pots with accessory Town 30 cup pot drawer adapters (pots and lids not available)
- Allows one pot per drawer of cooked rice for long term holding, with the option of serving from third pot in top heated well (HRDW-2U-1 only)
- Stainless steel construction, including back panel, handles the rigors of daily kitchen use
- Heavy-duty drawers and robust telescopic drawer slides makes pan removal easy and efficient
- Stainless steel utensil well and utensil pan included with HRDW-2U and HRDW-2U-1 models only
- Adjustable t-stat with knob for optimal rice holding in top well (HRDW-2U-1 only)
- Raised beveled edge on top of HRDW-2, HRDW-2U models only

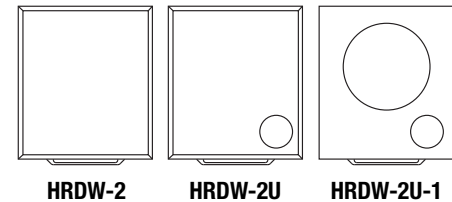

HRDW-2U-1 with accessory hinged lid and standard utensil well and utensil pan

HEATED RICE DRAWER WARMERS

Model	Dimensions [†] W x D x H	Voltage		Watts	Amps	Ship Weight [○]	List Price
		Single Phase					
HRDW-2	20¼" x 22¹³⁄₁₆" x 35½"	120		700	5.8	153 lbs.	\$5419
HRDW-2U	20¼" x 22¹³⁄₁₆" x 35½"	120		700	5.8	150 lbs.	5643
HRDW-2U-1	20¼" x 22¹³⁄₁₆" x 35½"	120		1150	9.6	128 lbs.	6327

† Add 1¾" to depth for drawer handle. Height does not include standard casters, which add 2.5" to height of unit

○ Does not include packaging.

All Heated Rice Drawer Warmer Models Feature:

Plug: NEMA 5-15P.

Models Shipped with: Utensil pan (HRDW-2U and HRDW-2U-1 only), 4" casters, 6' cord and plug.

Cord Location: Back of unit, upper left corner.

ACCESSORIES (available for purchase at any time)

HRDW-LID	Hinged aluminum lid for top rice well (HRDW-2U-1 only)	\$245
HRDW-TOWN30	One Drawer Adapter for Town 30 cup rice pots (one per drawer required)	145



HRDW-LID

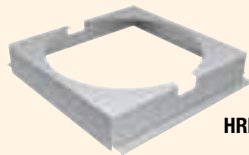

HRDW-TOWN30

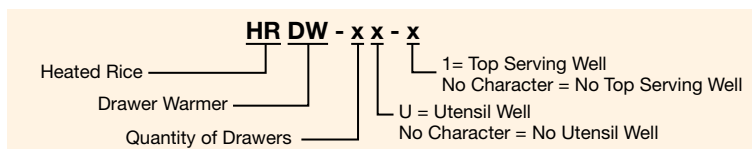

Merchandisers

*Cafeterias • Convenience Stores
Supermarkets & Delis • Restaurants & Cafés
Clubs & Bars • Catering • Concessions*



FS3HAC-2426 signs not included *pg. 149*



PDH-55T and **PSH-55D** shown on operator side *pg. 151*



GRPWS-4818T with base heat only (signs not included) *pg. 152*



GR2SDS-48D Designer Merchandiser with standard Black inset panels and corner caps *pg. 157*



HZMS-36D in standard Designer Black and optional Red LED accent lighting *pg. 160*



GR3SDS-27TCT in optional Designer Gray Grainite (signs not included) *pg. 164*



GRCMW-1DH in optional Bermuda Sand *pg. 165*



GRCD-2PD with optional self-closing flip-up doors and Designer Warm Red *pg. 166*



FSCDH-2PD in standard Designer Black, sign holder (sign not included), 3-sided skirt, perforated shelf, and Simulated Stone Night Sky base. *pg. 168*

Flav-R-Savor® Heated Air Curtain Merchandisers

The newest models of our patented Flav-R-Savor® Heated Air Curtain Merchandisers has no front doors, allowing customers easy access to fresh hot products. Heated air at the front of the cabinet is forced downward, forming a "curtain" of heated air. The heated air is then drawn toward the rear of the cabinet, warming each shelf gently and evenly.

- Perfect for wrapped or unwrapped food product.
- Consistent even temperatures result in longer quality hold times compared to traditional merchandisers
- The air temperature range is 70° - 175°F
- Easy to use digital controls
- Standard *Designer Powercoat Black* finish inside and outside for an uniform and sleek look to compliment any décor
- LED lighting on top front and sides, to create balanced lighting which showcases food product
- Removable shelves can be installed to be slanted or horizontal, with removable sign holders on each
- Front crumb tray lifts and pivots, and removable glass sides make for easy upkeep



FS3HAC-2426 with optional square side cut-outs and top sign holder (signs not included)



FS3HAC-3626
shelf signs not included



FS3HAC-4226
with optional tiered shelves

Merchandisers

HEATED AIR CURTAIN MERCHANDISERS

Model	Dimensions (W x D x H) height includes legs	Shelf Dimensions W x D	Voltage	Watts	Amps	Plugs	Shipping Weight	List Price
FS3HAC-2426	24" x 27 ³ / ₈ " x 38"	20 ¹ / ₈ " x 17"	120	1800	15.0	NEMA 5-15P [▲]	183 lbs.	\$ 9623
FS3HAC-3026	30" x 27 ³ / ₈ " x 38"	26 ¹ / ₈ " x 17"	120/208-240	3340	13.8	NEMA 14-20P	211 lbs.	10481
FS3HAC-3626	36" x 27 ³ / ₈ " x 38"	32 ¹ / ₈ " x 17"	120/208-240	3340	13.8	NEMA 14-20P	227 lbs.	11287
FS3HAC-4226	42" x 27 ³ / ₈ " x 38"	38" x 17"	120/208-240	3430	14.3	NEMA 14-20P	274 lbs.	12095

▲ Canadian Model uses NEMA 5-20P.

All Heated Air Curtain Merchandisers Models Feature:

Models Shipped with: FS3HAC-2426, -3026: One, swing-out left hinged rear door, three removeable shelves with sign holder in front, crumb tray, 4" legs and a 6' cord and plug.
FS3HAC-3626, -4226: Sliding glass rear door, three removeable shelves with sign holder in front, crumb tray, 4" legs and a 6' cord and plug.

Cord Location: Servers side, bottom left.

OPTIONS AND ACCESSORIES – PAGE 150

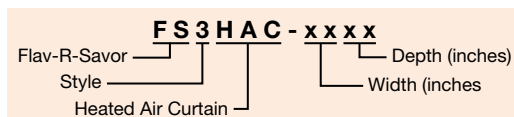



FS3HAC-2426 with optional square side cut-outs and top sign holder (signs not included)

OPTIONS (available at time of purchase only)

SIDECONTROL	Right- or Left-Hand Side Controls - must specify side at time of order	No Charge
RTHGDOOR	Right Hinged Access Door in lieu of Left Hinged Access Door (FS3HAC-2426, -3026 models only)	No Charge
TIERSHELVES	Tiered shelves in lieu of standard depth shelves	No Charge
PRODSTOP-STDSH	Side product stops for standard depth shelves	\$125
PRODSTOP-TIERSH	Side product stops for tiered shelves	14
SQSIDEPANEL	Square side cut-outs in lieu of curved side cut outs	No Charge
SIGN24	Sign Holder for the FS3HAC-2426. Sign dimensions: 23 ⁷ / ₈ " x 6 ³ / ₄ "	45
SIGN30	Sign Holder for the FS3HAC-3026. Sign dimensions: 29 ⁷ / ₈ " x 6 ³ / ₄ "	47
SIGN36	Sign Holder for the FS3HAC-3626. Sign dimensions: 35 ⁷ / ₈ " x 6 ³ / ₄ "	49
SIGN42	Sign Holder for the FS3HAC-4226. Sign dimensions: 41 ⁷ / ₈ " x 6 ³ / ₄ "	51
LOCKPLUG	NEMA L14-20P Locking plug in lieu of NEMA 14-20P (FS3HAC-3026, -3626, -4226 units only)	176

Side Stops/Divider Rails – Kits for order at time of purchase only –

RAIL-STD24	15 rails for 24 standard model (5 per shelf)	\$437
RAIL-STD30	18 rails for 30 standard model (6 per shelf)	523
RAIL-STD36	21 rails for 36 standard model (7 per shelf)	610
RAIL-STD42	24 rails for 42 standard model (8 per shelf)	696
RAIL-TR24	15 rails for 24 tiered model (5 per shelf)	417
RAIL-TR30	18 rails for 30 tiered model (6 per shelf)	501
RAIL-TR36	21 rails for 36 tiered model (7 per shelf)	583
RAIL-TR42	24 rails for 42 tiered model (8 per shelf)	666

ACCESSORIES (available for purchase at any time)

Side Stops/Divider Rails – Individually –

RAIL-TOPT-BLACK	Top tiered shelf in <i>Designer Black</i>	each \$27
RAIL-MIDT-BLACK	Middle tiered shelf in <i>Designer Black</i>	each 28
RAIL-STD-BLACK	Standard shelf and tiered bottom shelf in <i>Designer Black</i>	each 29



RAIL-MIDT-BLACK Use as side stops or divider rails

Product Heated Shelves

Perfect for sliced pizza sales on the bottom, and boxed carry-out pizzas on the top. Durable stainless steel construction with blanket elements on all shelf bases make for easy cleaning. The bottom, three shelf PDH-55T has energy efficient LED lights to showcase food to customers and encouraging impulse sales. The top dual shelf PSH-55D holds the carry-out orders.

PDH-55T (bottom three-shelf unit)

- Holds up to nine, 18" diameter pizzas
- Base and overhead heat for consistent and accurate holding of unwrapped pizzas for impulse sales
- Optional front glass for easy viewing by the customer
- Single on/off switch to control temperature for all shelves
- Standard side panel glass swings out for easy cleaning

PSH-55D (top two-shelf unit)

- Enclosed except for operator side, with base heat only, for boxed carry out sales
- Single on/off switch to control temperature for all shelves
- Customer side can be used for magnetic signage (signs not included)
- Brackets and cord clips included to attach to the top of the PDH-55T



Customer side shown
PSH-55D top unit
PSD-55T bottom unit with optional front glass panels



Operator side shown
PSH-55D top unit
PSD-55T bottom unit with optional front glass panels

Merchandisers

PRODUCT HEATED SHELVES

Model	Dimensions W x D x H	Usable Heated Shelf Space (W x D)	Voltage	Watts	Amps	Plug	Ship Weight	List Price
Dual Shelf								
PSH-55D	54½" x 20" x 16"	51½" x 18¾"	120	300	2.54	NEMA 5-15P	193 lbs.	\$4402
Triple Shelf								
PDH-55T	54½" x 20½" x 31½"•	51½" x 18¾"	120/208-240	4100	17.5	NEMA L14-20P [▲]	168 lbs.	\$9902

• Height includes 2.5" legs.
Canadian models use NEMA 14-30 or NEMA L14-30.

All Heated Glass Merchandiser Models Feature:

Cord Location: PSH-55D: Server side, bottom right
PDH-55T: Server side, bottom right on base.

OPTIONS (available at time of purchase only)

GLSSPNL Glass Panels on customer side on PDH-55T only **\$880**

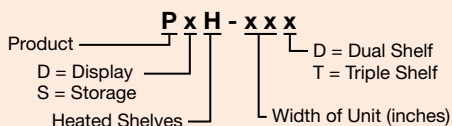



Glo-Ray® Pizza Warmers

Convenient for self-serve and quick-serve areas. The Hatco Glo-Ray® Pizza Warmers with base heat only hold boxed or bagged pizzas. Available in one, two, three or four shelf configuration, perfect for high volume applications.

- Box stop doubles as the sign holder (signs not included), a standard feature (excluding base only unit)
- Constructed of aluminum and stainless steel with tempered glass side panels (excluding base only unit)
- Separate power switch for each thermostatically-controlled shelf
- Dual and Triple Shelf units have LED lights, Quadruple Shelf units have incandescent lights



GRPWS-2424
with base heat only



GRPWS-2418D
(signs not included)



GRPWS-2424T
with optional
Designer Black



GRPWS-2418Q
(signs not included)

Merchandisers

SLANT DISPLAY WARMERS WITH BASE HEAT ONLY

Model	No. of Bulbs, Divider Rods	Dimensions (W x D x H) <i>Height includes legs</i>	Voltage Single Phase	Usable Heated Shelf Space (W x D)	Watts	Plug	Ship Weight	List Price
Base Only								
GRPWS-2424*	0,5	23 ¹ / ₈ " x 25" x 7 ¹ / ₈ "	120	22 ¹ / ₂ " x 21"	345	NEMA 5-15P	40 lbs.	\$2140
GRPWS-3624*	0,7	35 ¹ / ₈ " x 25" x 7 ¹ / ₈ "	120	34 ¹ / ₂ " x 21"	505	NEMA 5-15P	45 lbs.	2359
GRPWS-4824	0,9	47 ¹ / ₈ " x 25" x 10 ¹ / ₈ "	120	46 ¹ / ₂ " x 21"	660	NEMA 5-15P	60 lbs.	2642
Dual Shelf								
GRPWS-2418D	4,0	23 ³ / ₈ " x 20 ¹ / ₈ " x 22 ⁵ / ₈ "	120	22 ¹ / ₂ " x 17 ³ / ₄ "	720	NEMA 5-15P	76 lbs.	\$4274
GRPWS-3618D	6,0	35 ³ / ₈ " x 20 ¹ / ₈ " x 22 ⁵ / ₈ "	120	34 ¹ / ₂ " x 17 ³ / ₄ "	1080	NEMA 5-15P	91 lbs.	4828
GRPWS-4818D*	8,0	47 ³ / ₈ " x 20 ¹ / ₈ " x 22 ⁵ / ₈ "	120	46 ¹ / ₂ " x 17 ³ / ₄ "	1440	NEMA 5-20P	136 lbs.	5360
GRPWS-2424D	4,0	23 ³ / ₈ " x 26 ¹ / ₈ " x 23 ⁵ / ₈ "	120	22 ¹ / ₂ " x 23 ³ / ₄ "	1200	NEMA 5-15P	108 lbs.	4628
GRPWS-3624D*	6,0	35 ³ / ₈ " x 26 ¹ / ₈ " x 23 ⁵ / ₈ "	120	34 ¹ / ₂ " x 23 ³ / ₄ "	1800	NEMA 5-15P	136 lbs.	5261
GRPWS-4824D	8,0	47 ³ / ₈ " x 26 ¹ / ₈ " x 23 ⁵ / ₈ "	120/208-240	46 ¹ / ₂ " x 23 ³ / ₄ "	2390	NEMA L14-20P	177 lbs.	5885
Triple Shelf								
GRPWS-2418T	6,0	23 ³ / ₈ " x 20 ¹ / ₈ " x 29 ¹ / ₄ "	120	22 ¹ / ₂ " x 17 ³ / ₄ "	1440	NEMA 5-15P	98 lbs.	\$5501
GRPWS-3618T	9,0	35 ³ / ₈ " x 20 ¹ / ₈ " x 29 ¹ / ₄ "	120/208-240	34 ¹ / ₂ " x 17 ³ / ₄ "	2160	NEMA L14-20P	136 lbs.	6305
GRPWS-4818T	12,0	47 ³ / ₈ " x 20 ¹ / ₈ " x 29 ¹ / ₄ "	120/208-240	46 ¹ / ₂ " x 17 ³ / ₄ "	2880	NEMA L14-20P	175 lbs.	7280
GRPWS-2424T*	6,0	23 ³ / ₈ " x 26 ¹ / ₈ " x 30 ³ / ₄ "	120	22 ¹ / ₂ " x 23 ³ / ₄ "	1800	NEMA 5-15P	116 lbs.	6017
GRPWS-3624T	9,0	35 ³ / ₈ " x 26 ¹ / ₈ " x 30 ³ / ₄ "	120/208-240	34 ¹ / ₂ " x 23 ³ / ₄ "	2700	NEMA L14-20P	167 lbs.	7137
GRPWS-4824T*	12,0	47 ³ / ₈ " x 26 ¹ / ₈ " x 30 ³ / ₄ "	120/208-240	46 ¹ / ₂ " x 23 ³ / ₄ "	3585	NEMA L14-20P	227 lbs.	8052
Quadruple Shelf								
GRPWS-2418Q	8,0	23 ³ / ₈ " x 20 ¹ / ₈ " x 36 ⁷ / ₈ "	120/208-240	22 ¹ / ₂ " x 17 ³ / ₄ "	1920	NEMA L14-20P	119 lbs.	\$ 6782
GRPWS-3618Q	12,0	35 ³ / ₈ " x 20 ¹ / ₈ " x 36 ⁷ / ₈ "	120/208-240	34 ¹ / ₂ " x 17 ³ / ₄ "	2880	NEMA L14-20P	157 lbs.	8047
GRPWS-4818Q	16,0	47 ³ / ₈ " x 20 ¹ / ₈ " x 36 ⁷ / ₈ "	120/208-240	46 ¹ / ₂ " x 17 ³ / ₄ "	3840	NEMA L14-20P	214 lbs.	9128
GRPWS-2424Q	8,0	23 ³ / ₈ " x 26 ¹ / ₈ " x 37 ¹ / ₈ "	120/208-240	22 ¹ / ₂ " x 23 ³ / ₄ "	2400	NEMA L14-20P	151 lbs.	7444
GRPWS-3624Q	12,0	35 ³ / ₈ " x 26 ¹ / ₈ " x 37 ¹ / ₈ "	120/208-240	34 ¹ / ₂ " x 23 ³ / ₄ "	3600	NEMA L14-20P	214 lbs.	8863
GRPWS-4824Q*	16,0	47 ³ / ₈ " x 26 ¹ / ₈ " x 37 ¹ / ₈ "	120/208-240	46 ¹ / ₂ " x 23 ³ / ₄ "	4780	NEMA L14-20P	277 lbs.	10289

* Height includes 1" legs. Other models ship with 4" legs.

† Also available in 120/208-240V.

‡ Canadian models use NEMA 5-20P.

§ Canadian models use NEMA L14-30P.

All Slant Models Feature:

Cord Location: Server side, bottom right corner.

OPTIONS AND ACCESSORIES – PAGE 153

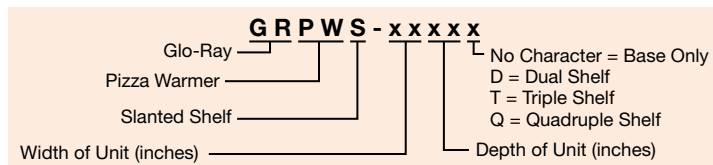



Merchandisers

GRPWS-4818T (signs not included)

OPTIONS (available at time of purchase only)

Designer Colors – Non-standard colors are non-returnable – Stainless Steel standard –

RED	Warm Red	\$460
BLACK	Black	460
GRAY	Gray Granite	460
WHITE	White Granite	460
NAVY	Navy Blue	460
GREEN	Hunter Green	460
COPPER	Antique Copper	460
HAL	60 Watt Halogen Bulb in lieu of Standard Display Light	each \$63

LED Lights in lieu of Standard Display Lights – Dual and Triple Shelf models only –

LED-WW-24	Warm White LED lighting for 24 width models	No Charge
LED-WW-36	Warm White LED lighting for 36 width models	No Charge
LED-WW-48	Warm White LED lighting for 48 width models	No Charge

ACCESSORIES (available for purchase at any time)

Chef LED 120V adjustable bulb – bulbs must be rotated down – See page 63 for more information – each \$129

- CLED-2700-120** Similar to warm Incandescent
- CLED-3000-120** Similar to warm Halogen light
- CLED-4000-120** Similar to cool Fluorescent light

COLORS AND FINISHES – INSIDE BACK COVER

RECOMMENDED SIGN DIMENSIONS

- Excluding base only units -

GRPWS-24 s: 22 1/4" x 2 5/8" x 1/8"

GRPWS-36 s: 34 1/4" x 2 5/8" x 1/8"

GRPWS-48 s: 46 1/4" x 2 5/8" x 1/8"

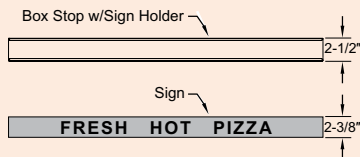

Glo-Ray® Merchandising Warmers

Designed with both a slanted and horizontal shelf, Glo-Ray® Merchandising Warmers offer the convenience of customer self-serve with the efficiency of preparing and holding product in advance for peak serving periods.

- Warmer includes a slant and horizontal shelf for merchandising a variety of products
- Standard Indicating Temperature Control (ITC) enhances accuracy and provides digital readout of temperatures
- Thermostatically-controlled hardcoated heated base to extend holding times
- Pre-focused infrared top heat directs heat to the outer edges where heat loss is greatest
- Product divider rods and 4" legs included
- Shatter-resistant incandescent lights illuminate the holding areas and emphasize the product
- Low watt models feature low watt overhead heat on the top shelf to hold popcorn. For fried food holding - select high watt models
- High watt models feature high watt overhead heat on top shelf to hold fried foods. For popcorn holding - select the lower watt models



GRSDS/H-36D with lower slant and upper horizontal shelf. Shown with optional 15" clearance - standard clearance is 12".



GRSDS/H-36DHW with lower slant and upper horizontal shelf. Shown with standard clearance of 12".

SLANT/HORIZONTAL DISPLAY WARMERS – DUAL SHELVES

Model	Dimensions W x D x H	Dimensions W x D x H	Voltage Single Phase	Watts	Plug	Ship Weight	List Price
Low Watt - Top shelf overhead heat is designed to hold popcorn.							
GRSDS/H-30D[▲]	4, 12	30" x 24¼" x 33½"	120	1530	NEMA 5-15P	140 lbs.	\$6859
GRSDS/H-36D	4, 14	36" x 24¼" x 33½"	120	1810	NEMA 5-20P	158 lbs.	7238
GRSDS/H-41D	6, 16	41" x 24¼" x 33½"	120/208-240	2120	NEMA L14-20P	178 lbs.	7747
High Watt - Top shelf overhead heat is designed to hold fries and sandwiches.							
GRSDS/H-30DHW[®]	4, 12	30" x 24¼" x 33½"	120/208-240	2450	NEMA L14-20P	140 lbs.	\$7161
GRSDS/H-36DHW[®]	4, 14	36" x 24¼" x 33½"	120/208-240	2910	NEMA L14-20P	158 lbs.	7540
GRSDS/H-41DHW[®]	6, 16	41" x 24¼" x 33½"	120/208-240	3360	NEMA L14-20P	178 lbs.	8049

▲ Canadian model uses NEMA 5-20P.

® High wattage on top shelf only.

All Slant/Horizontal Shelf Models Feature:

Cord Location – Back Counter Display Models: Server side, bottom right corner.

OPTIONS (available at time of purchase only)

Designer Colors – Non-standard colors are non-returnable

– Glossy Gray standard –

RED	Warm Red	\$460
BLACK	Black	460
GRAY	Gray Granite	460
WHITE	White Granite	460
NAVY	Navy Blue	460
GREEN	Hunter Green	460
COPPER	Antique Copper	460
15SPACE	15" clearance top shelf in lieu of standard 12" clearance (add 3" to height of unit)	\$134
HAL	60 Watt Halogen Bulb in lieu of Standard Display Light	each 63

ACCESSORIES (available for purchase at any time)

GRSDS-DIV	Additional Stainless Steel Divider Rods (Bottom shelf only)	each \$27
GRSDH-DIV	Additional Stainless Steel Divider Rods (Top shelf only)	each 27

COLORS AND FINISHES – INSIDE BACK COVER

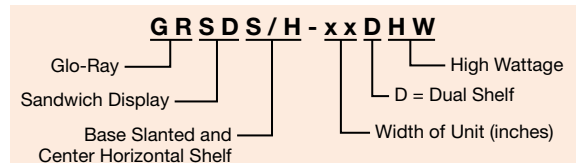

Glo-Ray® Merchandising Warmers

Designed specifically for showcasing wrapped or boxed product, the Hatco Glo-Ray® Merchandising Warmers hold hot food safely at proper serving temperatures. These warmers offer the convenience of self-serve and the efficiency of kitchen-to-server holding.

- Available in single- or two-tier models (slant models available in three-tier)
- Product divider rods sort food displays
- Thermostatically-controlled hardcoated heated base, with a temperature range of 185°- 200°F, to extend holding times
- Horizontal or slant shelves
- Pre-focused infrared top heat directs heat to the outer edges where heat loss is greatest
- Shatter-resistant incandescent lights illuminate the holding areas and emphasize the product

GRSDS-30 with accessory 4" legs



GRSDH-30D

GRSDS-36T with optional Designer Black



Quick-Ship Model pages 241-247

Merchandisers

HORIZONTAL MERCHANDISING WARMERS

Model	No. of Bulbs, Divider Rods	Dimensions (W x D x H) Height includes legs	Voltage	Usable Heated Shelf Space (W x D)	Watts	Plug	Ship Weight	List Price
Single Shelf								
GRSDH-24	2, 5	24" x 19½" x 12"	120	22¾" x 16½"	830	NEMA 5-15P	48 lbs.	\$3057
GRSDH-30	2, 6	30" x 19½" x 12"	120	28¾" x 16½"	970	NEMA 5-15P	56 lbs.	3334
GRSDH-36	2, 7	36" x 19½" x 12"	120	34¾" x 16½"	1170	NEMA 5-15P	66 lbs.	3611
GRSDH-41	3, 8	41" x 19½" x 15"	120	39¾" x 16½"	1340	NEMA 5-15P	74 lbs.	3933
GRSDH-52 [▲]	4, 10	52" x 19½" x 15"	120	50¾" x 16½"	1760	NEMA 5-15P	86 lbs.	4591
GRSDH-60	5, 12	60" x 19½" x 15"	120/208-240	58¾" x 16½"	2100	NEMA L14-20P	133 lbs.	5172
Dual Shelf								
GRSDH-24D [▲]	4, 10	24" x 19½" x 25¾"	120	22¾" x 16½"	1660	NEMA 5-15P	88 lbs.	\$5362
GRSDH-30D ^{▲*}	4, 12	30" x 19½" x 25¾"	120	28¾" x 16½"	1920	NEMA 5-20P	100 lbs.	5562
GRSDH-36D	4, 14	36" x 19½" x 25¾"	120/208-240	34¾" x 16½"	2340	NEMA L14-20P	120 lbs.	5888
GRSDH-41D [†]	6, 16	41" x 19½" x 25¾"	120/208-240	39¾" x 16½"	2680	NEMA L14-20P	137 lbs.	6256
GRSDH-52D [†]	8, 20	52" x 19½" x 25¾"	120/208-240	50¾" x 16½"	3520	NEMA L14-20P	172 lbs.	7208
GRSDH-60D ^{▲*}	10, 24	60" x 19½" x 25¾"	120/208-240	58¾" x 16½"	4200	NEMA L14-20P	197 lbs.	7945

SLANT MERCHANDISING WARMERS

Model	No. of Bulbs, Divider Rods	Dimensions (W x D x H) Height includes legs	Voltage	Usable Heated Shelf Space (W x D)	Watts	Plug	Ship Weight	List Price
Single Shelf								
✓ GRSDS-24	2, 5	24" x 24¼" x 18½"	120	22½" x 21"	695	NEMA 5-15P	79 lbs.	\$3677
GRSDS-30	2, 6	30" x 24¼" x 18½"	120	28½" x 21"	790	NEMA 5-15P	80 lbs.	3943
GRSDS-36	2, 7	36" x 24¼" x 21½"	120	34½" x 21"	935	NEMA 5-15P	92 lbs.	4247
GRSDS-41	3, 8	41" x 24¼" x 21½"	120	39½" x 21"	1090	NEMA 5-15P	96 lbs.	4558
GRSDS-52	4, 10	52" x 24¼" x 21½"	120	50½" x 21"	1400	NEMA 5-15P	110 lbs.	5231
GRSDS-60 [▲]	5, 12	60" x 24¼" x 21½"	120	58½" x 21"	1715	NEMA 5-15P	167 lbs.	5651
Dual Shelf								
GRSDS-24D	4, 10	24" x 24¼" x 32¾"	120	22½" x 21"	1355	NEMA 5-15P	115 lbs.	\$5748
✓ GRSDS-30D [▲]	4, 12	30" x 24¼" x 32¾"	120	28½" x 21"	1530	NEMA 5-15P	140 lbs.	6099
✓ GRSDS-36D	4, 14	36" x 24¼" x 32¾"	120	34½" x 21"	1810	NEMA 5-20P	160 lbs.	6497
GRSDS-41D [†]	6, 16	41" x 24¼" x 32¾"	120/208-240	39½" x 21"	2120	NEMA L14-20P	180 lbs.	6986
GRSDS-52D [†]	8, 20	52" x 24¼" x 32¾"	120/208-240	50½" x 21"	2725	NEMA L14-20P	215 lbs.	8115
GRSDS-60D	10, 24	60" x 24¼" x 32¾"	120/208-240	58½" x 21"	3340	NEMA L14-20P	238 lbs.	8620
Triple Shelf								
GRSDS-24T [§]	6, 15	23¾" x 24¼" x 43¾"	120	22½" x 21"	2015	NEMA 5-20P	164 lbs.	\$7348
GRSDS-36T	6, 21	35¾" x 24¼" x 43¾"	120/208-240	34½" x 21"	2685	NEMA L14-20P	219 lbs.	7961

▲ Canadian models use NEMA 5-20P.

* For Canada only, external fuse box on top of unit, adds 3" to height.

† Requires 2, 120V power cords.

‡ Canadian models uses NEMA L14-30P.

§ Not available for Canada.

All Merchandising Warmer Models Feature:

Cord Location: Horizontal Models: Left rear corner toward server side.

Slant Models: Server side, bottom right corner.

OPTIONS AND ACCESSORIES – PAGE 156

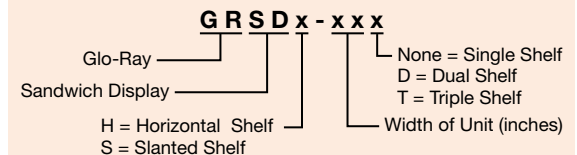



Two GRSDH-36D with dual horizontal shelves

OPTIONS (available at time of purchase only) (not available on Quick-Ship)

ITC-S	Indicating Temperature Control (LED) for single shelf	\$335
ITC-D	Indicating Temperature Control (LED) for dual shelf	578
SSEND	Stainless Steel End Panels in lieu of Glass End Panels	per shelf 46
5" Sneeze Guard (GRSDS one side, GRSDH two sides) –		
GRSD24BP	24" wide models	per shelf \$ 153
GRSD30BP	30" wide models	per shelf 182
GRSD36BP	36" wide models	per shelf 213
GRSD41BP	41" wide models	per shelf 244
GRSD52BP	52" wide models	per shelf 277
GRSD60BP	60" wide models	per shelf 392
HAL	60 Watt Halogen Bulb in lieu of Standard Display Light	each \$63
GRSDFLIPLOCK1	Flip-Up Door Locking Plate (for GRSDS, GRSDS-xxD, and GRSDS-xxT 24" to 41" wide models)	per shelf 20
GRSDFLIPLOCK2	Flip-up Door Locking Plates (for GRSDS and GRSDS-xxD 52" to 60" wide models)	per shelf 45

Display Sign Holder (Signs not included) – Color Matches Unit Color – Top or Intermediate Shelf (Slant or Horizontal models) –

GRSD-SIGN24	24" width. Requires 22 $\frac{3}{8}$ "W x 3 $\frac{3}{8}$ "H x 1 $\frac{1}{16}$ "D sign	each \$140
GRSD-SIGN30	30" width. Requires 28 $\frac{3}{8}$ "W x 3 $\frac{3}{8}$ "H x 1 $\frac{1}{16}$ "D sign	each 145
GRSD-SIGN36	36" width. Requires 34 $\frac{3}{8}$ "W x 3 $\frac{3}{8}$ "H x 1 $\frac{1}{16}$ "D sign	each 152
GRSD-SIGN41	41" width. Requires 39 $\frac{3}{8}$ "W x 3 $\frac{3}{8}$ "H x 1 $\frac{1}{16}$ "D sign	each 158
GRSD-SIGN52	52" width. Requires 50 $\frac{3}{8}$ "W x 3 $\frac{3}{8}$ "H x 1 $\frac{1}{16}$ "D sign	each 171
GRSD-SIGN60	60" width. Requires 58 $\frac{3}{8}$ "W x 3 $\frac{3}{8}$ "H x 1 $\frac{1}{16}$ "D sign	each 186

Plexi-Glass Flip-Up Doors on one side for GRSDS models – Not compatible with optional Sneeze Guards or Display Sign Holders in same opening –

SDS24FLIP	24" wide models	per shelf \$278
SDS30FLIP	30" wide models	per shelf 278
SDS36FLIP	36" wide models	per shelf 278
SDS41FLIP	41" wide models	per shelf 278
SDS52FLIP	52" wide models	per shelf 474
SDS60FLIP	60" wide models	per shelf 474

Plexi-Glass Flip-Up Doors on one side for GRSDH models – Not compatible with optional Sneeze Guards or Display Sign Holders in same opening –

GRSDH24FLIP	24" wide models	per shelf \$278
GRSDH30FLIP	30" wide models	per shelf 278
GRSDH36FLIP	36" wide models	per shelf 278
GRSDH41FLIP	41" wide models	per shelf 278
GRSDH52FLIP	52" wide models	per shelf 474
GRSDH60FLIP	60" wide models	per shelf 474

ACCESSORIES (available for purchase at any time)

4" LEGS	4" Adjustable Legs (standard on units GRSDH-41 and larger, GRSDS-36 and larger and all duals)	Set of 4 \$ 60
Chef LED 120V adjustable bulb – bulbs must be rotated down – See page 63 for more information –		each 129
	CLED-2700-120 Similar to warm Incandescent	
	CLED-3000-120 Similar to warm Halogen light	
	CLED-4000-120 Similar to cool Fluorescent light	
GRSDH-DIV	Additional Stainless Steel Divider Rods – Horizontal model	each \$27
GRSDS-DIV	Additional Stainless Steel Divider Rods – Slant model	each 27

OPTIONS (available at time of purchase only) (not available on Quick-Ship)

Designer Colors – Non-standard colors are non-returnable – Glossy Gray standard –

RED	Warm Red	\$460
BLACK	Black	460
GRAY	Gray Granite	460
WHITE	White Granite	460
NAVY	Navy Blue	460
GREEN	Hunter Green	460
COPPER	Antique Copper	460

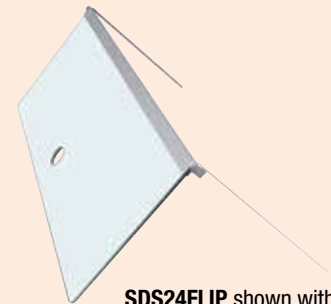
COLORS AND FINISHES – INSIDE BACK COVER

SDS24FLIP shown with brackets for retrofit



-2700, -3000 or -4000 Accessory

Glo-Ray® Designer Merchandising Warmers

Boost impulse sales by showcasing your hot foods in the Hatco Glo-Ray® Designer Merchandising Warmers. Designed specifically for displaying wrapped or boxed product, these warmers hold hot food safely at proper serving temperatures.

- Constructed of aluminum and stainless steel with tempered glass side panels
- Pre-focused infrared top heat directs heat to the outer edges where heat loss is greatest
- Convenient for self-serve or quick-serve areas
- Available in single- or two-tier models
- Horizontal or slant shelves
- Thermostatically-controlled hardcoated heated base extends holding times

- Product divider rods sort food displays
- Shatter-resistant incandescent lights illuminate the holding areas and emphasize the product



GR2SDH-30 with optional Designer Black inset panels and accessory flip-up plexi-glass door

NOTE: Designer Series width dimensions are 6¼" greater than the number listed in model.

DESIGNER HORIZONTAL DISPLAY WARMERS

Model*	No. of Bulbs, Divider Rods	Dimensions W x D x H (Height includes legs)	Voltage	Usable Heated Shelf Space (W x D)	Watts	Plug	Ship Weight	List Price
Single Shelf								
GR2SDH-24	2, 5	30¼" x 27" x 18½"	120	23⅞" x 22"	820	NEMA 5-15P	87 lbs.	\$4061
GR2SDH-30	2, 6	36¼" x 27" x 18½"	120	29⅞" x 22"	1020	NEMA 5-15P	120 lbs.	4372
GR2SDH-36	2, 7	42¼" x 27" x 18½"	120	35⅞" x 22"	1220	NEMA 5-15P	129 lbs.	4691
GR2SDH-42 [▲]	4, 8	48¼" x 27" x 18½"	120	41⅞" x 22"	1490	NEMA 5-15P	138 lbs.	5203
GR2SDH-48 [▲]	4, 9	54¼" x 27" x 18½"	120	47⅞" x 22"	1690	NEMA 5-15P	160 lbs.	5718
GR2SDH-54	4, 10	60¼" x 27" x 18½"	120	53⅞" x 22"	1890	NEMA 5-20P	172 lbs.	6244
GR2SDH-60	6, 12	66¼" x 27" x 18½"	120	59⅞" x 22"	2210	NEMA 5-30P	200 lbs.	6724
Dual Shelf								
GR2SDH-24D [▲]	4, 10	30¼" x 27" x 29"	120	23⅞" x 22"	1640	NEMA 5-15P	126 lbs.	\$6720
GR2SDH-30D	4, 12	36¼" x 27" x 29"	120/208-240	29⅞" x 22"	2040	NEMA L14-20P	158 lbs.	7109
GR2SDH-36D	4, 14	42¼" x 27" x 29"	120/208-240	35⅞" x 22"	2440	NEMA L14-20P	205 lbs.	7476
GR2SDH-42D	8, 16	48¼" x 27" x 29"	120/208-240	41⅞" x 22"	2980	NEMA L14-20P	225 lbs.	8187
GR2SDH-48D	8, 18	54¼" x 27" x 29"	120/208-240	47⅞" x 22"	3380	NEMA L14-20P	254 lbs.	8888
GR2SDH-54D	8, 20	60¼" x 27" x 29"	120/208-240	53⅞" x 22"	3780	NEMA L14-20P	274 lbs.	9611
GR2SDH-60D	12, 24	66¼" x 27" x 29"	120/208-240	59⅞" x 22"	4420	NEMA L14-30P	328 lbs.	10296

DESIGNER SLANT DISPLAY WARMERS

Model*	No. of Bulbs, Divider Rods	Dimensions W x D x H (Height includes legs)	Voltage	Usable Heated Shelf Space (W x D)	Watts	Plug	Ship Weight	List Price
Single Shelf								
GR2SDS-24	2, 5	30¼" x 26¾" x 22⅞"	120	23⅞" x 22"	820	NEMA 5-15P	102 lbs.	\$4386
GR2SDS-30	2, 6	36¼" x 26¾" x 22⅞"	120	29⅞" x 22"	1020	NEMA 5-15P	110 lbs.	4630
GR2SDS-36	2, 7	42¼" x 26¾" x 22⅞"	120	35⅞" x 22"	1220	NEMA 5-15P	136 lbs.	5036
GR2SDS-42 [▲]	4, 8	48¼" x 26¾" x 22⅞"	120	41⅞" x 22"	1490	NEMA 5-15P	155 lbs.	5546
GR2SDS-48 [▲]	4, 9	54¼" x 26¾" x 22⅞"	120	47⅞" x 22"	1690	NEMA 5-15P	164 lbs.	6048
GR2SDS-54	4, 10	60¼" x 26¾" x 22⅞"	120	53⅞" x 22"	1890	NEMA 5-20P	182 lbs.	6561
GR2SDS-60	6, 12	66¼" x 26¾" x 22⅞"	120	59⅞" x 22"	2210	NEMA 5-30P	202 lbs.	7029
Dual Shelf								
GR2SDS-24D [▲]	4, 10	30¼" x 26¾" x 33⅞"	120	23⅞" x 22"	1640	NEMA 5-15P	160 lbs.	\$ 6841
GR2SDS-30D	4, 12	36¼" x 26¾" x 33⅞"	120/208-240	29⅞" x 22"	2040	NEMA L14-20P	184 lbs.	7324
GR2SDS-36D	4, 14	42¼" x 26¾" x 33⅞"	120/208-240	35⅞" x 22"	2440	NEMA L14-20P	200 lbs.	7785
GR2SDS-42D	8, 16	48¼" x 26¾" x 33⅞"	120/208-240	41⅞" x 22"	2980	NEMA L14-20P	218 lbs.	8509
GR2SDS-48D	8, 18	54¼" x 26¾" x 33⅞"	120/208-240	47⅞" x 22"	3380	NEMA L14-20P	255 lbs.	9208
GR2SDS-54D	8, 20	60¼" x 26¾" x 33⅞"	120/208-240	53⅞" x 22"	3780	NEMA L14-20P	265 lbs.	9926
GR2SDS-60D	12, 24	66¼" x 26¾" x 33⅞"	120/208-240	59⅞" x 22"	4420	NEMA L14-30P	296 lbs.	10612

* When no color is specified, color inset panels and corner caps will be Black.

▲ Canadian models use NEMA 5-20P.

All Designer Models Feature:

Cord Location: Server side, bottom center.

OPTIONS AND ACCESSORIES – PAGE 158

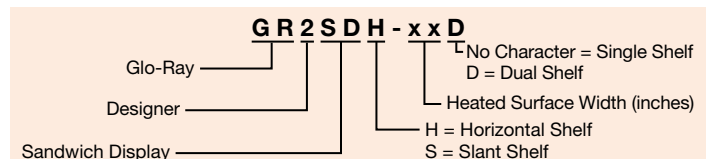



GR2SDS-24D with optional Designer color inset panels

FSDT-1 with accessory food pans

OPTIONS (available at time of purchase only)

Designer Corner Caps – Designer Black standard – DKGRAY Dark Gray Corner Caps

No Charge

5" Sneeze Guard – Customer side only on Slant models –

GR2SD24BP	30¼" wide models	per shelf	\$124
GR2SD30BP	36¼" wide models	per shelf	155
GR2SD36BP	42¼" wide models	per shelf	186
GR2SD42BP	48¼" wide models	per shelf	217
GR2SD48BP	54¼" wide models	per shelf	248
GR2SD54BP	60¼" wide models	per shelf	279
GR2SD60BP	66¼" wide models	per shelf	310

Plexi-Glass Flip-up Doors – on Control or Customer Side –

2SDS24FLIP	30¼" wide models	per shelf	\$207
2SDS30FLIP	36¼" wide models	per shelf	237
2SDS36FLIP	42¼" wide models	per shelf	270
2SDS42FLIP	48¼" wide models	per shelf	306
2SDS48FLIP	54¼" wide models - split doors	per shelf	359
2SDS54FLIP	60¼" wide models - split doors	per shelf	417
2SDS60FLIP	66¼" wide models - split doors	per shelf	479

2SDHFRTGLS Front Glass in lieu of Channel Dividers and Divider Rods. Cannot have Sneeze Guards or Flip-Up Doors (GR2SDH series, single models only) **\$113**

2SDHFRTGLS-D Front Glass in lieu of Channel Dividers and Divider Rods. Cannot have Sneeze Guards or Flip-Up Doors (GR2SDH series, dual models only) **226**

HAL 60 Watt Halogen Bulb in lieu of Standard Display Light **each 63**

SS-ITC Indicating Temperature Control (LED) for single shelf (adds 1⅞" to Horizontal model depth and 1¾" to Slant model depth) **335**

DS-ITC Indicating Temperature Control (LED) for dual shelf (adds 1⅞" to Horizontal model depth and 1¾" to Slant model depth) **578**

ACCESSORIES (available for purchase at any time)

2SD-DIV Additional Stainless Steel Divider Rods **each \$ 27**

Chef LED 120V adjustable bulb – bulbs must be rotated down – See page 63 for more information – **each 129**

CLED-2700-120 Similar to warm Incandescent

CLED-3000-120 Similar to warm Halogen light

CLED-4000-120 Similar to cool Fluorescent light

COLORS AND FINISHES – INSIDE BACK COVER

CLED-2700, -3000 or -4000
Accessory



OPTIONS

(available at time of purchase only)

Designer Colors –

Non-standard colors are non-returnable –

Clear Anodized Aluminum standard –

RED	Warm Red	\$460
BLACK	Black	460
GRAY	Gray Granite	460
WHITE	White Granite	460
NAVY	Navy Blue	460
GREEN	Hunter Green	460
COPPER	Antique Copper	460

Designer Inset Panel Colors –

Non-standard colors are non-returnable –

Black standard –

RED	Warm Red	No Charge
GRAY	Gray Granite	No Charge
WHITE	White Granite	No Charge
NAVY	Navy Blue	No Charge
GREEN	Hunter Green	No Charge
COPPER	Antique Copper	No Charge



SS-ITC Optional



DS-ITC Optional

Heated LED Merchandisers

The Heated Merchandiser with LED lighting is sleekly designed to safely hold hot packaged food to attract your grab-and-go customers. Available in slant or horizontal shelves, the Heated LED Merchandising Warmers are offered in both single and dual shelf models.

- Choose from slant or horizontal, single or dual shelf models
- Infrared heat safely holds hot packaged product for hours
- High efficiency LED lighting creates better illumination of food product in the holding area
- Feature a thermostatically-controlled hardcoated heated base shelf
- Hinged glass side panels are held in place magnetically and swing out for easy cleaning
- An optional Indicating Temperature Control (ITC) enhances accurate control of temperature



HXMS-36D
in standard
Designer Black

HORIZONTAL HEATED LED MERCHANDISING WARMERS

Model	Divider Rods	Dimensions (W x D x H) <i>Height includes legs</i>	Heated Shelf Space (W x D)	Voltage	Watts	Amps	Plug	Ship Weight*	List Price
Horizontal Single Shelf									
HXMH-24	5	28" x 28 ⁵ / ₈ " x 21 ¹ / ₈ "	22 ³ / ₈ " x 21 ³ / ₄ "	120	700	5.8	NEMA 5-15P	120 lbs.	\$4543
HXMH-30	6	34" x 28 ⁵ / ₈ " x 21 ¹ / ₈ "	28 ⁵ / ₈ " x 21 ³ / ₄ "	120	900	7.5	NEMA 5-15P	133 lbs.	4874
HXMH-36	7	40" x 28 ⁵ / ₈ " x 21 ¹ / ₈ "	34 ³ / ₈ " x 21 ³ / ₄ "	120	1100	9.2	NEMA 5-15P	145 lbs.	5203
HXMH-42	8	46" x 28 ⁵ / ₈ " x 21 ¹ / ₈ "	40 ³ / ₈ " x 21 ³ / ₄ "	120	1200	10.0	NEMA 5-15P	161 lbs.	5743
HXMH-48	9	52" x 28 ⁵ / ₈ " x 21 ¹ / ₈ "	46 ³ / ₈ " x 21 ³ / ₄ "	120	1450	12.1	NEMA 5-20P	190 lbs.	6284
HXMH-54	10	58" x 28 ⁵ / ₈ " x 21 ¹ / ₈ "	52 ³ / ₈ " x 21 ³ / ₄ "	120	1650	13.8	NEMA 5-20P	200 lbs.	6824
HXMH-60	12	64" x 28 ⁵ / ₈ " x 21 ¹ / ₈ "	58 ³ / ₈ " x 21 ³ / ₄ "	120	1850	15.4	NEMA 5-20P	206 lbs.	7319
Horizontal Dual Shelf									
HXMH-24D	10	28" x 28 ⁵ / ₈ " x 32 ⁷ / ₈ "	22 ³ / ₈ " x 21 ³ / ₄ "	120	1400	11.7	NEMA 5-15P	160 lbs.	\$ 7401
HXMH-30D	12	34" x 28 ⁵ / ₈ " x 32 ⁷ / ₈ "	28 ⁵ / ₈ " x 21 ³ / ₄ "	120/208-240	1800	7.5	NEMA L14-20P	185 lbs.	7914
HXMH-36D	14	40" x 28 ⁵ / ₈ " x 32 ⁷ / ₈ "	34 ³ / ₈ " x 21 ³ / ₄ "	120/208-240	2200	9.2	NEMA L14-20P	205 lbs.	8277
HXMH-42D	16	46" x 28 ⁵ / ₈ " x 32 ⁷ / ₈ "	40 ³ / ₈ " x 21 ³ / ₄ "	120/208-240	2400	10.0	NEMA L14-20P	220 lbs.	9031
HXMH-48D	18	52" x 28 ⁵ / ₈ " x 32 ⁷ / ₈ "	46 ³ / ₈ " x 21 ³ / ₄ "	120/208-240	2900	12.1	NEMA L14-20P	244 lbs.	9764
HXMH-54D	20	58" x 28 ⁵ / ₈ " x 32 ⁷ / ₈ "	52 ³ / ₈ " x 21 ³ / ₄ "	120/208-240	3300	13.8	NEMA L14-20P	271 lbs.	10510
HXMH-60D	24	64" x 28 ⁵ / ₈ " x 32 ⁷ / ₈ "	58 ³ / ₈ " x 21 ³ / ₄ "	120/208-240	3700	15.4	NEMA L14-20P	300 lbs.	11199

SLANT HEATED LED MERCHANDISING WARMERS

Model	Divider Rods	Dimensions (W x D x H) <i>Height includes legs</i>	Heated Shelf Space (W x D)	Voltage	Watts	Amps	Plug	Ship Weight*	List Price
Slant Single Shelf									
HXMS-24	5	28" x 28 ⁵ / ₈ " x 21 ³ / ₄ "	22 ³ / ₈ " x 21 ³ / ₄ "	120	700	5.8	NEMA 5-15P	112 lbs.	\$4729
HXMS-30	6	34" x 28 ⁵ / ₈ " x 21 ³ / ₄ "	28 ⁵ / ₈ " x 21 ³ / ₄ "	120	900	7.5	NEMA 5-15P	133 lbs.	4991
HXMS-36	7	40" x 28 ⁵ / ₈ " x 21 ³ / ₄ "	34 ³ / ₈ " x 21 ³ / ₄ "	120	1100	9.2	NEMA 5-15P	150 lbs.	5429
HXMS-42	8	46" x 28 ⁵ / ₈ " x 21 ³ / ₄ "	40 ³ / ₈ " x 21 ³ / ₄ "	120	1200	10.0	NEMA 5-15P	161 lbs.	5974
HXMS-48	9	52" x 28 ⁵ / ₈ " x 21 ³ / ₄ "	46 ³ / ₈ " x 21 ³ / ₄ "	120	1450	12.1	NEMA 5-20P	188 lbs.	6517
HXMS-54	10	58" x 28 ⁵ / ₈ " x 21 ³ / ₄ "	52 ³ / ₈ " x 21 ³ / ₄ "	120	1650	13.8	NEMA 5-20P	205 lbs.	7070
HXMS-60	12	64" x 28 ⁵ / ₈ " x 21 ³ / ₄ "	58 ³ / ₈ " x 21 ³ / ₄ "	120	1850	15.4	NEMA 5-20P	205 lbs.	7577
Slant Dual Shelf									
HXMS-24D	10	28" x 28 ⁵ / ₈ " x 32 ³ / ₄ "	22 ³ / ₈ " x 21 ³ / ₄ "	120	1400	11.7	NEMA 5-15P	160 lbs.	\$ 7401
HXMS-30D	12	34" x 28 ⁵ / ₈ " x 32 ³ / ₄ "	28 ⁵ / ₈ " x 21 ³ / ₄ "	120/208-240	1800	7.5	NEMA L14-20P	187 lbs.	7914
HXMS-36D	14	40" x 28 ⁵ / ₈ " x 32 ³ / ₄ "	34 ³ / ₈ " x 21 ³ / ₄ "	120/208-240	2200	9.2	NEMA L14-20P	208 lbs.	8388
HXMS-42D	16	46" x 28 ⁵ / ₈ " x 32 ³ / ₄ "	40 ³ / ₈ " x 21 ³ / ₄ "	120/208-240	2400	10.0	NEMA L14-20P	232 lbs.	9164
HXMS-48D	18	52" x 28 ⁵ / ₈ " x 32 ³ / ₄ "	46 ³ / ₈ " x 21 ³ / ₄ "	120/208-240	2900	12.1	NEMA L14-20P	245 lbs.	9925
HXMS-54D	20	58" x 28 ⁵ / ₈ " x 32 ³ / ₄ "	52 ³ / ₈ " x 21 ³ / ₄ "	120/208-240	3300	13.8	NEMA L14-20P	270 lbs.	10698
HXMS-60D	24	64" x 28 ⁵ / ₈ " x 32 ³ / ₄ "	58 ³ / ₈ " x 21 ³ / ₄ "	120/208-240	3700	15.4	NEMA L14-20P	291 lbs.	11434

* Shipping weights are approximate.

All Heated LED Merchandising Warmer Models Feature:

Cord Location: Server side, bottom center on left side of control box.

OPTIONS AND ACCESSORIES – PAGE 161

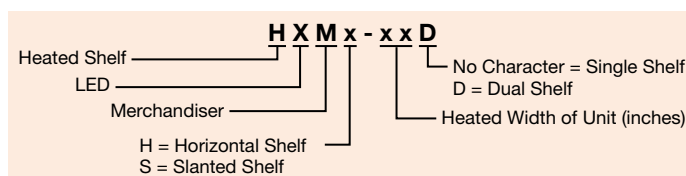



Heated Zone Merchandisers

The energy-efficient Hatco Heated Zone Merchandiser safely holds hot packaged food in eye catching design to draw in your customers, while LED lighting showcases your food product. Hatco's Spot-On® Technology will reduce your energy consumption while keeping your foods at the desired temperature.

- Spot-On technology turns overhead heat on only when product is present in that zone, while base heat goes from energy saving mode to the temperature you set
- Our fast action ribbon elements will be up to temperature in less than 10 seconds
- Choose from slant or horizontal shelves, single or dual shelf models, and in 2 to 12 zones depending on the model size
- LCD display scans and displays the various zone settings

- Hinged glass side panels swing out for easy cleaning
- Channel dividers are held in place by magnets, giving the unit more heated surface



HZMH-24 in standard Designer Black



Merchandisers

HORIZONTAL HEATED ZONE MERCHANDISING WARMERS

Model	Zones per Shelf	Divider Rods	Dimensions (W x D x H) <i>Height includes legs</i>	Usable Heated Surface per Zone (W x D)	Voltage Single Phase	Watts	Plug	Shipping Weight	List Price
Horizontal Single Shelf									
HZMH-24	2	3	28" x 28 ⁵ / ₈ " x 21 ³ / ₈ "	20" x 21 ³ / ₄ "	120	750	NEMA 5-15P	125 lbs	\$5902
HZMH-30	4	4	34" x 28 ⁵ / ₈ " x 21 ³ / ₈ "	12 ³ / ₈ " x 21 ³ / ₄ "	120	1350	NEMA 5-15P	141 lbs	6318
HZMH-36	4	4	40" x 28 ⁵ / ₈ " x 21 ³ / ₈ "	15 ³ / ₈ " x 21 ³ / ₄ "	120	1400	NEMA 5-15P	159 lbs	6741
HZMH-42	4	6	46" x 28 ⁵ / ₈ " x 21 ³ / ₈ "	18 ³ / ₈ " x 21 ³ / ₄ "	120	1450	NEMA 5-20P	172 lbs	7428
HZMH-48	4	6	52" x 28 ⁵ / ₈ " x 21 ³ / ₈ "	21 ³ / ₈ " x 21 ³ / ₄ "	120	1500	NEMA 5-20P	182 lbs	8110
HZMH-54	6	6	58" x 28 ⁵ / ₈ " x 21 ³ / ₈ "	15 ¹ / ₁₆ " x 21 ³ / ₄ "	120	2100	NEMA 5-30P	202 lbs	8804
HZMH-60	6	9	64" x 28 ⁵ / ₈ " x 21 ³ / ₈ "	17 ¹ / ₁₆ " x 21 ³ / ₄ "	120	2150	NEMA 5-30P	216 lbs	9452
Horizontal Dual Shelf									
HZMH-24D	2	6	28" x 28 ⁵ / ₈ " x 32 ³ / ₈ "	20" x 21 ³ / ₄ "	120	1500	NEMA 5-20P	176 lbs	\$ 9803
HZMH-30D	4	8	34" x 28 ⁵ / ₈ " x 32 ³ / ₈ "	12 ³ / ₈ " x 21 ³ / ₄ "	120/208-240	2700	NEMA L14-20P	204 lbs	10318
HZMH-36D	4	8	40" x 28 ⁵ / ₈ " x 32 ³ / ₈ "	15 ³ / ₈ " x 21 ³ / ₄ "	120/208-240	2800	NEMA L14-20P	228 lbs	10795
HZMH-42D	4	12	46" x 28 ⁵ / ₈ " x 32 ³ / ₈ "	18 ³ / ₈ " x 21 ³ / ₄ "	120/208-240	2900	NEMA L14-20P	246 lbs	12128
HZMH-48D	4	12	52" x 28 ⁵ / ₈ " x 32 ³ / ₈ "	21 ³ / ₈ " x 21 ³ / ₄ "	120/208-240	3000	NEMA L14-20P	265 lbs	12702
HZMH-54D	6	12	58" x 28 ⁵ / ₈ " x 32 ³ / ₈ "	15 ¹ / ₁₆ " x 21 ³ / ₄ "	120/208-240	4200	NEMA L14-30P	308 lbs	13652
HZMH-60D	6	18	64" x 28 ⁵ / ₈ " x 32 ³ / ₈ "	17 ¹ / ₁₆ " x 21 ³ / ₄ "	120/208-240	4300	NEMA L14-30P	331 lbs	14571

SLANT HEATED ZONE MERCHANDISING WARMERS

Model	Zones per Shelf	Divider Rods	Dimensions (W x D x H) <i>Height includes legs</i>	Usable Heated Surface per Zone (W x D)	Voltage Single Phase	Watts	Plug	Shipping Weight	List Price
Slant Single Shelf									
HZMS-24	2	3	28" x 28 ⁵ / ₈ " x 21 ³ / ₄ "	20" x 21 ³ / ₄ "	120	750	NEMA 5-15P	120 lbs	\$6393
HZMS-30	4	4	34" x 28 ⁵ / ₈ " x 21 ³ / ₄ "	12 ³ / ₈ " x 21 ³ / ₄ "	120	1350	NEMA 5-15P	145 lbs	6721
HZMS-36	4	4	40" x 28 ⁵ / ₈ " x 21 ³ / ₄ "	15 ³ / ₈ " x 21 ³ / ₄ "	120	1400	NEMA 5-15P	159 lbs	7268
HZMS-42	4	6	46" x 28 ⁵ / ₈ " x 21 ³ / ₄ "	18 ³ / ₈ " x 21 ³ / ₄ "	120	1450	NEMA 5-20P	172 lbs	7950
HZMS-48	4	6	52" x 28 ⁵ / ₈ " x 21 ³ / ₄ "	21 ³ / ₈ " x 21 ³ / ₄ "	120	1500	NEMA 5-20P	187 lbs	8622
HZMS-54	6	6	58" x 28 ⁵ / ₈ " x 21 ³ / ₄ "	15 ¹ / ₁₆ " x 21 ³ / ₄ "	120	2100	NEMA 5-30P	202 lbs	9313
HZMS-60	6	9	64" x 28 ⁵ / ₈ " x 21 ³ / ₄ "	17 ¹ / ₁₆ " x 21 ³ / ₄ "	120	2150	NEMA 5-30P	216 lbs	9941
Slant Dual Shelf									
HZMS-24D	2	6	28" x 28 ⁵ / ₈ " x 32 ³ / ₄ "	20" x 21 ³ / ₄ "	120	1500	NEMA 5-20P	176 lbs	\$10042
HZMS-30D	4	8	34" x 28 ⁵ / ₈ " x 32 ³ / ₄ "	12 ³ / ₈ " x 21 ³ / ₄ "	120/208-240	2700	NEMA L14-20P	209 lbs	10696
HZMS-36D	4	8	40" x 28 ⁵ / ₈ " x 32 ³ / ₄ "	15 ³ / ₈ " x 21 ³ / ₄ "	120/208-240	2800	NEMA L14-20P	223 lbs	11321
HZMS-42D	4	12	46" x 28 ⁵ / ₈ " x 32 ³ / ₄ "	18 ³ / ₈ " x 21 ³ / ₄ "	120/208-240	2900	NEMA L14-20P	248 lbs	12290
HZMS-48D	4	12	52" x 28 ⁵ / ₈ " x 32 ³ / ₄ "	21 ³ / ₈ " x 21 ³ / ₄ "	120/208-240	3000	NEMA L14-20P	263 lbs	13295
HZMS-54D	6	12	58" x 28 ⁵ / ₈ " x 32 ³ / ₄ "	15 ¹ / ₁₆ " x 21 ³ / ₄ "	120/208-240	4200	NEMA L14-30P	298 lbs	14201
HZMS-60D	6	18	64" x 28 ⁵ / ₈ " x 32 ³ / ₄ "	17 ¹ / ₁₆ " x 21 ³ / ₄ "	120/208-240	4300	NEMA L14-30P	332 lbs	15119

All Heated Zone Merchandising Warmer Models Feature:
Cord Location: Server side, bottom center on left side of control box.

OPTIONS AND ACCESSORIES – PAGE 161

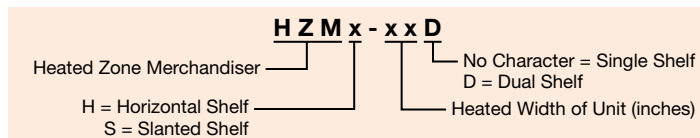



HZMS-48D in standard *Designer Black* with optional LED accent lighting in support posts

OPTIONS (available at time of purchase only)

Designer Colors – Non-standard colors are non-returnable – Black standard –

RED	Warm Red	\$460
GRAY	Gray Granite	460
WHITE	White Granite	460
NAVY	Navy Blue	460
GREEN	Hunter Green	460
COPPER	Antique Copper	460

HZM-LP	Red LED Accent Lighting in support post (HXM and HZM models)	\$700
---------------	--	--------------

Wire Guards – Single shelf, Slant and Horizontal models – HZM models only –

HZMWG-24	Wire Guard on -24 models	\$ 86
HZMWG-30 -36 -42 -48	Wire Guard on -30, -36, -42 or -48 models	172
HZMWG-54 -60	Wire Guard on -54 or -60 models	258

Wire Guards – Dual shelf, Slant and Horizontal models – HZM models only –

HZMWG-24D	Wire Guard on -24D Models	\$172
HZMWG-30D -36D -42D -48D	Wire Guard on -30D, -36D, -42D or -48D Models	344
HZMWG-54D -60D	Wire Guard on -54D or -60D Models	516

SS-ITC	Indicating Temperature Control (LED) for single shelf (for HXM models only)	\$335
---------------	---	--------------

DS-ITC	Indicating Temperature Control (LED) for dual shelf (for HXM models only)	578
---------------	---	------------

Sneeze Guards – HXM and HZM models – Not compatible with Flip-Up Doors in same opening –

HZM24BP	5" Sneeze Guard on Customer Side on -24 models	per shelf \$257
HZM30BP	5" Sneeze Guard on Customer Side on -30 models	per shelf 280
HZM36BP	5" Sneeze Guard on Customer Side on -36 models	per shelf 303
HZM42BP	5" Sneeze Guard on Customer Side on -42 models	per shelf 334
HZM48BP	5" Sneeze Guard on Customer Side on -48 models	per shelf 364
HZM54BP	5" Sneeze Guard on Customer Side on -54 models	per shelf 396
HZM60BP	5" Sneeze Guard on Customer Side on -60 models	per shelf 428

Flip-Up Doors – HXM and HZM models – Not compatible with Sneeze Guards in same opening, one side only –

HZM24FLIP	Plexi-Glass Flip-up Doors on Control or Customer side on -24 models	per shelf \$258
HZM30FLIP	Plexi-Glass Flip-up Doors on Control or Customer side on -30 models	per shelf 280
HZM36FLIP	Plexi-Glass Flip-up Doors on Control or Customer side on -36 models	per shelf 305
HZM42FLIP	Plexi-Glass Flip-up Doors on Control or Customer side on -42 models	per shelf 333
HZM48FLIP	Plexi-Glass Flip-up Doors on Control or Customer side on -48 models	per shelf 362
HZM54FLIP	Plexi-Glass Flip-up Doors on Control or Customer side on -54 models	per shelf 396
HZM60FLIP	Plexi-Glass Flip-up Doors on Control or Customer side on -60 models	per shelf 432

ACCESSORIES (available for purchase at any time)

HZM-DIV	Additional Stainless Steel Divider Rods (HXM and HZM models)	each \$29
----------------	--	------------------

COLORS AND FINISHES – INSIDE BACK COVER

Glo-Ray® Heated Glass Merchandisers

Hatco's patented heated glass shelves provide maximum product visibility while increasing product capacity. All models are available in *Designer* colors or stainless steel, with tempered glass end panels, a thermostatically-controlled heated base, product divider rods and 2½" legs.

- The heated glass shelves make these self-serve merchandisers uniquely visual
- Patented heated glass shelf provides an even heat source for top and bottom heat to safely hold product
- Thermostatically-controlled, hardcoated heated base
- Standard 2½" adjustable legs (adds 2⅜" to height of unit)
- Available in horizontal or slanted versions to meet your needs or style
- *Designer* color models, posts, base panels and sign holder for top and middle shelves optional. Non-standard colors are non-returnable
- Flip-up doors and 4" legs available
- LED lights showcase food product and saves energy and money
- Modular design accommodates side-by-side expansion



GR3SDH-39
in optional
Stainless Steel finish



GR3SDS-39D
in optional
Designer Navy Blue

Merchandisers

HORIZONTAL DISPLAY WARMERS WITH HEATED GLASS

Model	No. of Rods	Dimensions W x D x H*	Usable Heated Shelf Space (W x D)	Voltage	Watts	Plug	Ship Weight	List Price
Single Shelf								
GR3SDH-27	10	27¼" x 27¼" x 13¾"	23¼" x 21¼"	120	997	NEMA 5-15P	108 lbs.	\$4684
GR3SDH-33	12	33¼" x 27¼" x 13¾"	29¼" x 21¼"	120	1251	NEMA 5-15P	120 lbs.	5049
GR3SDH-39 [▲]	14	39¼" x 27¼" x 13¾"	35¼" x 21¼"	120	1505	NEMA 5-15P	133 lbs.	5425
Dual Shelf								
GR3SDH-27D [▲]	15	27¼" x 27¼" x 23½"	23¼" x 21¼"	120	1769	NEMA 5-15P	147 lbs.	\$7767
GR3SDH-33D	18	33¼" x 27¼" x 23½"	29¼" x 21¼"	120/208-240	2227	NEMA L14-20P	166 lbs.	8208
GR3SDH-39D	21	39¼" x 27¼" x 23½"	35¼" x 21¼"	120/208-240	2685	NEMA L14-20P	194 lbs.	8626

SLANT DISPLAY WARMERS WITH HEATED GLASS

Model	No. of Rods	Dimensions W x D x H*	Usable Heated Shelf Space (W x D)	Voltage	Watts	Plug	Ship Weight	List Price
Single Shelf								
GR3SDS-27	10	27¼" x 26⅞" x 18⅞"	23¼" x 21¼"	120	997	NEMA 5-15P	115 lbs.	\$5058
GR3SDS-33	12	33¼" x 26⅞" x 18⅞"	29¼" x 21¼"	120	1251	NEMA 5-15P	127 lbs.	5347
GR3SDS-39	14	39¼" x 26⅞" x 18⅞"	35¼" x 21¼"	120	1505	NEMA 5-15P	156 lbs.	5813
Dual Shelf								
GR3SDS-27D	15	27¼" x 26⅞" x 28⅞"	23¼" x 21¼"	120	1769	NEMA 5-15P	164 lbs.	\$7882
GR3SDS-33D	18	33¼" x 26⅞" x 28⅞"	29¼" x 21¼"	120/208-240	2227	NEMA L14-20P	190 lbs.	8438
GR3SDS-39D	21	39¼" x 26⅞" x 28⅞"	35¼" x 21¼"	120/208-240	2685	NEMA L14-20P	206 lbs.	8972

* Height does not include 2⅝" legs.

[▲] Canadian models use NEMA 5-20P.

All Models Feature:

Cord Location: Server side, bottom right corner.

OPTIONS AND ACCESSORIES – PAGE 163

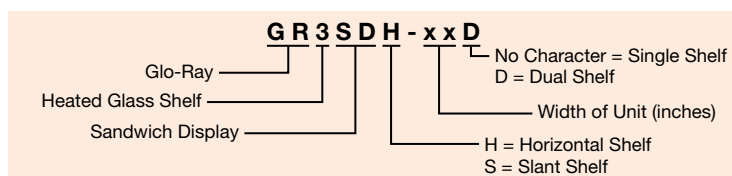



GR3SDS-39D in optional
Designer Antique Copper

Merchandisers

OPTIONS (available at time of purchase only)

Designer Colors – Non-standard colors are non-returnable – Black standard –

RED	Warm Red	No Charge
GRAY	Gray Granite	No Charge
WHITE	White Granite	No Charge
NAVY	Navy Blue	No Charge
GREEN	Hunter Green	No Charge
COPPER	Antique Copper	No Charge
GR3-SS	Stainless Steel Body and Base (unpainted posts)	\$265
GR3SD27BP	5" Sneeze Guard on Customer side on 27¼" wide models	per shelf 217
GR3SD33BP	5" Sneeze Guard on Customer side on 33¼" wide models	per shelf 229
GR3SD39BP	5" Sneeze Guard on Customer side on 39¼" wide models	per shelf 244
3SD27FLIP	Plexi-Glass Flip-Up Doors on front or back on 27¼" wide models	per shelf 162
3SD33FLIP	Plexi-Glass Flip-Up Doors on front or back on 33¼" wide models	per shelf 198
3SD39FLIP	Plexi-Glass Flip-Up Doors on front or back on 39¼" wide models	per shelf 236
3SDEND	Plexi-Glass End Panels in lieu of Glass End Panels	per shelf 24

Painted Shelf Sign Holder (Signs not included) – Color matches unit color – Top or Intermediate Shelf – (Slant or Horizontal models) –

3SD27SIGN	27" width model. Requires 27"W x 2½"H x ½"D Sign	each \$ 97
3SD33SIGN	33" width model. Requires 33"W x 2½"H x ½"D Sign	each 105
3SD39SIGN	39" width model. Requires 39"W x 2½"H x ½"D Sign	each 113

ACCESSORIES (available for purchase at any time)

4" LEGS	4" Adjustable Legs	Set of 4 \$60
3SD-DIV	Additional Stainless Steel Divider Rods	each 27

COLORS AND FINISHES – INSIDE BACK COVER

Glo-Ray® Heated Glass Merchandisers

Glo-Ray® Heated Glass Merchandising Warmers are perfect for self-serve operations, designed specifically to hold hot wrapped or boxed product at optimum serving temperatures. Increasing holding capacities and impulse sales with a beautiful curved design that compliments any décor.

- Unique, patented heated glass shelves with infinite controls conduct heat to food product above and below
- Blanket-style heating elements in the hardcoated base and canopy are thermostatically-controlled
- LED lighting allows for optimum food product display with energy savings
- Attractive curved top design includes a built-in top sign holder (sign not included)
- Also comes with: tempered glass side panels, 2.5" legs, thermostatically-controlled heated base and upper canopy, divider rods and comes standard in *Designer Black*



GR3SDS-39DCT in standard *Designer Black* and top sign holder (sign not included)



GR3SDS-27TCT in optional Glossy Gray and shelf sign holders (sign not included)

SLANT DISPLAY WARMERS WITH HEATED GLASS

Model	No. of Rods	Dimensions W x D x H*	Usable Heated Shelf Space (W x D)	Voltage	Watts	Plug	Ship Weight	List Price
Dual Shelf								
GR3SDS-27DCT	10	27 ¹ / ₄ " x 27 ⁷ / ₈ " x 26 ³ / ₈ "	23 ¹ / ₄ " x 21 ¹ / ₄ "	120	1340	NEMA 5-15P	155 lbs.	\$7323
GR3SDS-33DCT	12	33 ¹ / ₄ " x 27 ⁷ / ₈ " x 26 ³ / ₈ "	29 ¹ / ₄ " x 21 ¹ / ₄ "	120	1747	NEMA 5-15P▲	175 lbs.	8211
GR3SDS-39DCT	14	39 ¹ / ₄ " x 27 ¹ / ₂ " x 26 ¹ / ₂ "	35 ¹ / ₄ " x 21 ¹ / ₄ "	120/208-240	2130	NEMA 5-15P	186 lbs.	9219
Triple Shelf								
GR3SDS-27TCT	15	27 ¹ / ₄ " x 29" x 34 ³ / ₈ "	23 ¹ / ₄ " x 21 ¹ / ₄ "	120/208-240	2095	NEMA L14-20P	190 lbs.	\$ 9422
GR3SDS-33TCT	18	33 ¹ / ₄ " x 28" x 34 ³ / ₈ "	29 ¹ / ₄ " x 21 ¹ / ₄ "	120/208-240	2723	NEMA L14-20P	215 lbs.	10914
GR3SDS-39TCT	21	39 ¹ / ₄ " x 27 ¹ / ₂ " x 34 ³ / ₄ "	35 ¹ / ₄ " x 21 ¹ / ₄ "	120/208-240	3310	NEMA L14-20P	230 lbs.	12105

* Height includes 2.5" legs.
▲ Canadian models use NEMA 5-20P.

All Heated Glass Merchandiser Models Feature:
Cord Location: Server side, bottom right corner.

OPTIONS (available at time of purchase only)

Designer Colors – Non-standard colors are non-returnable – Black standard –		
RED	Warm Red	\$460
GRAY	Gray Granite	460
WHITE	White Granite	460
NAVY	Navy Blue	460
GREEN	Hunter Green	460
COPPER	Antique Copper	460
Gloss Finish – Non-standard colors are non-returnable – Black standard –		
GGRAY	Glossy Gray	\$460

ACCESSORIES (available for purchase at any time)

4" LEGS	4" Adjustable Legs	Set of 4 \$60
3SD-DIV	Additional Stainless Steel Divider Rods	each 27

COLORS AND FINISHES – INSIDE BACK COVER

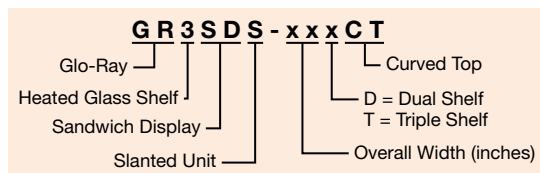

Glo-Ray® Curved Merchandising Warmers

Looking to add a touch of class to a new point-of-sale area or to change or upgrade an existing area? Hatco's Glo-Ray® Curved Merchandising Warmer offers a unique and attractive solution for impulse sales areas.

- Single shelf and dual shelf units come standard with mirrored glass back panel
- Individual thermostatically-controlled heated base with master rocker switch maintains safe serving temperatures
- Halogen lighting allows for optimal food product display
- Humidified dual shelf unit contains a five cup capacity water reservoir
- Models with Simulated Stone are Swanstone®



GRCMW-1 in standard Designer Black with food pans (not available)



GRCMW-1DH in standard Designer Black with food pans (not available)

CURVED MERCHANDISING WARMERS

Model	Dimensions W x D x H	Voltage Single Phase	Usable Heated Surface Space (W x D)		Watts	Plug	Ship Weight	List Price
			Top Shelf	Bottom Shelf				
Single Shelf								
GRCMW-1	22 ¹ / ₈ " x 21 ¹ / ₂ " x 19 ⁷ / ₈ "	120	—	19 ³ / ₄ " x 13"	670	NEMA 5-15P	56 lbs.	\$3459
Dual Shelf								
GRCMW-1D[▲]	26" x 20 ¹ / ₈ " x 26 ⁷ / ₈ "	120	22 ³ / ₄ " x 12 ³ / ₈ "	22 ³ / ₄ " x 15 ⁵ / ₈ "	1540	NEMA 5-15P	92 lbs.	\$6630
Dual Shelf with Humidity[★]								
GRCMW-1DH[▲]	26" x 20 ¹ / ₈ " x 26 ⁷ / ₈ "	120	22 ³ / ₄ " x 12 ³ / ₈ "	22 ³ / ₄ " x 15 ⁵ / ₈ "	1660	NEMA 5-15P	100 lbs.	\$7093

▲ Canadian models use NEMA 5-20P.

★ Humidity on bottom shelf only.

All Curved Merchandising Warming Models Feature:

Water Reservoir Capacity (GRCMW-1DH model only): 5 cups.

Cord Location: Server side, bottom right corner.

WATER QUALITY REQUIREMENTS – PAGE 248

OPTIONS (available at time of purchase only)

Designer Colors (unit's painted surface) – Non-standard colors are non-returnable

– Black standard –

RED	Warm Red	No Charge
GRAY	Gray Granite	No Charge
WHITE	White Granite	No Charge
NAVY	Navy Blue	No Charge
GREEN	Hunter Green	No Charge
COPPER	Antique Copper	No Charge

Simulated Stone Color (unit's painted surface and decorative trim inserts)

– Non-standard colors are non-returnable –

GGRAN	Gray Granite	\$609
BSAND	Bermuda Sand	609
NSKY	Night Sky	609
CMWDBACKFLIP	Top and bottom shelf flip-up doors on server's side in lieu of mirrored back panel (GRCMW-1D, -1DH Models only)	\$ 41
CMWDTOPFLIP	Top Shelf Flip-up Door on Customer Side in lieu of Sneeze Guard (GRCMW-1D, -1DH Models only)	206

FOOD PANS AND TRIVETS – PAGE 240

COLORS AND FINISHES – INSIDE BACK COVER

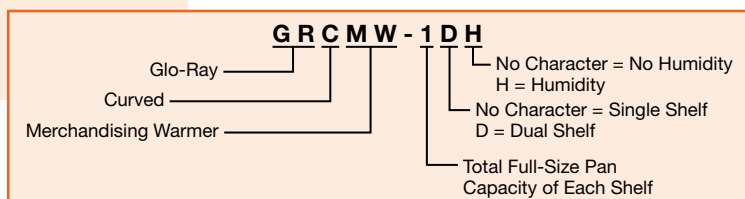

Merchandisers

Glo-Ray® Designer Heated Display Cases

Our Designer series Glo-Ray® Heated Display Case with curved glass and incandescent lighting will display your offering with flare and elegance. We combine our thermostatically-controlled heated base and infrared overhead heating to blanket your offering at the perfect temperature.

- The tempered curved glass design offers a great line of sight to draw in your customers
- Exclusive cool base construction
- Rollerless sliding doors
- Available with or without controlled humidity (bottom shelf only)
- Constructed of aluminum and stainless steel with tempered glass
- Curved glass front tilts forward for easy cleaning

- Pre-focused infrared top heat directs heat to the outer edges where heat loss is greatest
- Shatter-resistant incandescent lights illuminate the food product



Humidified reservoir is located in between pans

Merchandisers



GRCD-2P with pan rail and optional Designer color, backlit sign holder (sign not included) and accessory food pans



GRCD-2PD with optional pan skirt, Designer Hunter Green and flip-up doors, and accessory food pans



GRCDH-1PD with pan skirt and new optional flip-up doors and accessory food pans. (top baking dish not available)



GRCDH-3PD shown in standard Stainless Steel with accessory food pans

Quick-Ship Model pages 241-247

DESIGNER DISPLAY CASES

Model	No. of Bulbs	Dimensions (W x D x H) <i>Height includes legs</i>	Usable Heated Shelf Space (W x D)	Voltage Single Phase	Watts	Plug	Ship Weight	List Price
Single Shelf								
GRCD-1P	2	20 ⁵ / ₈ " x 26" x 24"	18 ¹ / ₈ " x 21"	120	410	NEMA 5-15P	95 lbs.	\$5227
GRCD-2P	3	32 ¹ / ₂ " x 26" x 24"	30" x 21"	120	780	NEMA 5-15P	120 lbs.	5973
GRCD-3P	3	45 ¹ / ₂ " x 26" x 24"	43" x 21"	120	1005	NEMA 5-15P	152 lbs.	6722
Dual Shelf								
GRCD-1PD	4	20 ⁵ / ₈ " x 26" x 31 ³ / ₄ "	18 ¹ / ₈ " x 21"	120	860	NEMA 5-15P	98 lbs.	\$6109
GRCD-2PD	6	32 ¹ / ₂ " x 26" x 31 ³ / ₄ "	30" x 21"	120	1210	NEMA 5-15P	170 lbs.	6963
✓ GRCD-3PD [▲]	6	45 ¹ / ₂ " x 26" x 31 ³ / ₄ "	43" x 21"	120	1710	NEMA 5-15P	210 lbs.	8028
Single Shelf with Humidity[☆]								
GRCDH-1P	2	20 ⁵ / ₈ " x 26" x 24"	18 ¹ / ₈ " x 21"	120	660	NEMA 5-15P	90 lbs.	\$5974
GRCDH-2P	3	32 ¹ / ₂ " x 26" x 24"	30" x 21"	120	1030	NEMA 5-15P	124 lbs.	6723
GRCDH-3P [▲]	3	45 ¹ / ₂ " x 26" x 24"	43" x 21"	120	1255	NEMA 5-15P	156 lbs.	7472
Dual Shelf with Humidity[☆]								
GRCDH-1PD	4	20 ⁵ / ₈ " x 26" x 31 ³ / ₄ "	18 ¹ / ₈ " x 21"	120	1110	NEMA 5-15P	120 lbs.	\$6857
GRCDH-2PD [▲]	6	32 ¹ / ₂ " x 26" x 31 ³ / ₄ "	30" x 21"	120	1460	NEMA 5-15P	174 lbs.	7713
✓ GRCDH-3PD [▲]	6	45 ¹ / ₂ " x 26" x 31 ³ / ₄ "	43" x 21"	120	1960	NEMA 5-20P	220 lbs.	8778

✓ Quick-Ship not available for Canada.

▲ Canadian models use NEMA 5-20P.

☆ Humidity on bottom shelf only. Includes pan skirt on bottom shelf.

* Not available for Canada with Backlit Base Sign Holder, and Canadian models use NEMA 5-30P.

All Models Feature:

Water Reservoir Capacity (Humidified Models only): 3 quarts.

Cord Location: Server side, bottom right corner.

OPTIONS – PAGE 167

WATER QUALITY REQUIREMENTS – PAGE 248

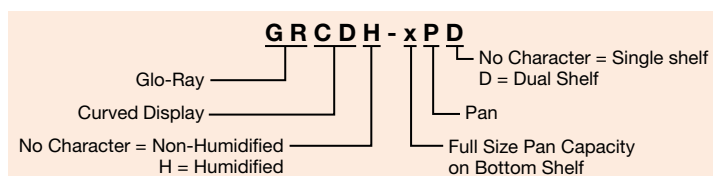



GRCD-2PD with optional self-closing flip-up doors and *Designer Warm Red*

Merchandisers

OPTIONS (available at time of purchase only) (not available on Quick-Ship)

Backlit Base Sign Holder, 120V only (Sign not included) –		
BCKLIT SIGN 2-PAN	2-Pan Models (25 lbs.) Requires 32½"W x 5"H x ¼"D Translucent Sign	\$717
BCKLIT SIGN 3-PAN	3-Pan Models (28 lbs.) Requires 45½"W x 5"H x ¼"D Translucent Sign	796

Self-Closing Flip-Up Doors on both shelves on customer side in lieu of Glass Front (adds ½" depth to unit) –

CD1PDFLIP	1-Pan models	\$ 830
CD2PDFLIP	2-Pan models	889
CD3PDFLIP	3-Pan models	1568
HAL	60 Watt Halogen Bulb in lieu of Standard Display Light	each \$63

Pan Skirt on bottom shelf (accommodates 2½"D Pans – standard on humidified models) –

SKIRT-1P	1-Pan model in lieu of Pan Rail	\$ 57
SKIRT-2P	2-Pan model in lieu of Pan Rail	103
SKIRT-3P	3-Pan model in lieu of Pan Rail	147
UPPERSKIRT-2P	Pan Skirt for upper shelf of 2-Pan models	105
UPPERSKIRT-3P	Pan Skirt for upper shelf of 3-Pan models	210

Mirrored Glass Doors in lieu of Glass Doors (Server side only) –

Single Shelf Models –		
MIRROR-1P	1-Pan single model	add \$ 90
MIRROR-2P	2-Pan single model	add 125
MIRROR-3P	3-Pan single model	add 160

Dual Shelf Models –

MIRROR-1PD	1-Pan dual model	add \$180
MIRROR-2PD	2-Pan dual model	add 250
MIRROR-3PD	3-Pan dual model	add 362

FOOD PANS AND TRIVETS – PAGE 240

OPTIONS (available at time of purchase only) (not available on Quick-Ship)

Designer Colors – Non-standard colors are non-returnable – Stainless Steel standard –

RED	Warm Red	\$460
BLACK	Black	460
GRAY	Gray Granite	460
WHITE	White Granite	460
NAVY	Navy Blue	460
GREEN	Hunter Green	460
COPPER	Antique Copper	460

COLORS AND FINISHES – INSIDE BACK COVER

HEATED DISPLAY CASE MAXIMUM PAN CAPACITIES*

Model	Pan Capacity	Optional Pan Skirt Frames
GRCD-1P	1 Full-Size Pan	One SKIRT-1P
GRCD-2P	2 Full-Size Pans	One SKIRT-2P
GRCD-3P	3 Full-Size Pans	One SKIRT-3P
GRCD-1PD	Top Shelf 1 Half-Size Pan or 1-14" Pizza Pan	None
	Bottom Shelf 1 Full-Size Pan	One SKIRT-1P
GRCD-2PD	Top Shelf 1 Full-Size Pan and 1 Third-Size Pan or 2-14" Pizza Pans	One UPPERSKIRT-2P
	Bottom Shelf 2 Full-Size Pans	One SKIRT-2P
GRCD-3PD	Top Shelf 2 Full-Size Pans or 3-14" Pizza Pans	One UPPERSKIRT-3P
	Bottom Shelf 3 Full-Size Pans	One SKIRT-3P

* All pan capacities shown are for non-humidified models.
2½" deep pans recommended for bottom shelf of humidified models.



Flav-R-Savor® Convected Air, Curved Front Display Cases

This front-of-the-house curved glass merchandiser utilizes convected air technology for superior holding times. Maintaining peak serving temperatures for unwrapped foods makes this Hatco display case perfect for cafeteria and deli-style service.

- Perforated stainless steel shelf not only enhances air movement over food products, but looks great as well
- Focused lighting to enhance and merchandise your food products
- Easy to read, digitally-controlled temperature and humidity (FSCDH-2PD model only) display for precise control
- Standard sign holder promotes your product offering on bottom front of unit (sign not included). Recommended sign dimension: 33 1/8"W x 6"H
- Rear French doors for easy access
- Hinged, tempered front glass panel tilts forward for easy cleaning

- Optional glass shelf available
- Night Sky Simulated Stone panel on bottom shelf is standard, optional in Gray Granite or Bermuda Sand. Non-standard colors are non-returnable
- Models with Simulated Stone are Swanstone®



FSCDH-2PD in standard *Designer* Black with sign holder (sign not included), 3-sided skirt, perforated shelf and Night Sky Simulated Stone base. Also with accessory risers and food pans.

CONVECTED AIR, CURVED FRONT DISPLAY CASES

Model	Dimensions W x D x H	Voltage Single Phase	Watts	Plug	Ship Weight	List Price
Non-Humidified						
FSCD-2PD	34 3/8" x 30 7/8" x 31 1/8"	120	1800	NEMA 5-20P	205 lbs.	\$8029
Humidified						
FSCDH-2PD	34 3/8" x 31 1/8" x 31 1/8"	120/208-240	2805	NEMA L14-20P	190 lbs.	\$8777

All Convected Air Display Models Feature:

Models Shipped With: Perforated upper shelf, heated Simulated stone base shelf, three-sided skirt and sign holder on bottom front. (sign not included) (recommended sign dimension: 33 1/8"W x 6"H).

Shelf Dimensions: Upper: 31 1/4"W x 16"D.
Lower: 32 1/4"W x 19 3/4"D.

Water Reservoir Capacity (Humidified model only): 7 quarts.

Cord Location: Server side, bottom center on left side of control box.

WATER QUALITY REQUIREMENTS – PAGE 248

OPTIONS (available at time of purchase only)

Designer Colors – Non-standard colors are non-returnable – Black standard –

RED	Warm Red	No Charge
GRAY	Gray Granite	No Charge
WHITE	White Granite	No Charge
NAVY	Navy Blue	No Charge
GREEN	Hunter Green	No Charge
COPPER	Antique Copper	No Charge

Simulated Stone Colors – Non-standard colors are non-returnable – Night Sky standard –

SS-GGRAN	Gray Granite	No Charge
SS-BSAND	Bermuda Sand	No Charge

FSCDH-PLUMB	Valve Relocation allows draining from back of unit instead of directly under unit (Humidified model only)	\$208
FSCD-GLASS	Glass Center Shelf (in lieu of perforated metal shelf)	No Charge



1 RISER10
Accessory

ACCESSORIES (available for purchase at any time)

1 RISER10	10"D x 1 1/4"H Circular Perforated Riser in Stainless Steel	\$42
------------------	---	-------------

COLORS AND FINISHES – INSIDE BACK COVER

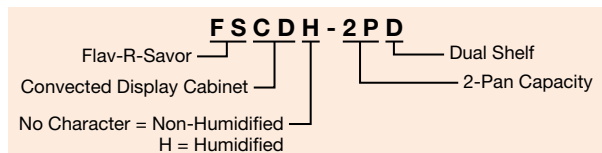

Glo-Ray® Heated Display Cases

Designed for “show and sell” areas in any foodservice operation, the Hatco Glo-Ray® Heated Display is perfect for hot food merchandising. Top and bottom heat combine to keep all food at that “just-made” taste and temperature longer.

- Thermostatically-controlled heated base (100° - 200°F) to extend holding times
- Pre-focused infrared top heat directs heat to the outer edges where heat loss is greatest
- Constructed of aluminum and stainless steel with tempered glass
- Shatter-resistant incandescent lights illuminate the food product
- Exclusive cool base construction minimizes heat transfer, keeping exterior base cool
- Rollerless sliding doors



GRHD-4PD with optional *Designer Antique Copper* and mirrored glass doors and accessory food pans



GRHDH-2P with standard pan skirt, optional double side opening, and accessory food pans

Merchandisers

DISPLAY CASES

Model	No. of Bulbs	Dimensions W x D x H (Height includes legs)	Voltage	Watts	Plug	Ship Weight	List Price
Single Shelf							
GRHD-2P	4	32½" x 26" x 25"	120	940	NEMA 5-15P	120 lbs.	\$4438
GRHD-3P	5	45½" x 26" x 25"	120	1350	NEMA 5-15P	143 lbs.	5079
GRHD-4P [▲]	6	58½" x 26" x 25"	120	1785	NEMA 5-15P	215 lbs.	6003
Dual Shelf							
GRHD-2PD	6	32½" x 26" x 30"	120	1310	NEMA 5-15P	150 lbs.	\$6124
GRHD-3PD [▲]	8	45½" x 26" x 30"	120	1755	NEMA 5-15P	188 lbs.	6880
GRHD-4PD [▲]	8	58½" x 26" x 30"	120	2480	NEMA 5-30P	230 lbs.	7909
Single Shelf with Humidity[★]							
GRHDH-2P	4	32½" x 26" x 25"	120	1190	NEMA 5-15P	125 lbs.	\$5196
GRHDH-3P [▲]	5	45½" x 26" x 25"	120	1600	NEMA 5-15P	162 lbs.	5837
GRHDH-4P [▲]	6	58½" x 26" x 25"	120	2285	NEMA 5-30P	215 lbs.	7298
Dual Shelf with Humidity[★]							
GRHDH-2PD [▲]	6	32½" x 26" x 30"	120	1560	NEMA 5-15P	175 lbs.	\$6875
GRHDH-3PD [▲]	8	45½" x 26" x 30"	120	2005	NEMA 5-20P	188 lbs.	7631
GRHDH-4PD [§]	8	58½" x 26" x 30"	120	2980	NEMA 5-30P	240 lbs.	9200

▲ Also available in 120/208V or 120/240V.

▲ Canadian models use NEMA 5-20P.

★ Humidity on bottom shelf only. Includes pan skirt on bottom shelf.

▲ Canadian model uses NEMA 5-30P.

§ Not available in 120V for Canada.

All Models Feature:

Usable Heated Shelf Space: Width of unit minus 4½" x 21½"D.

Water Reservoir Capacity (Humidified models only): 2-Pan and 3-Pan: 3 quarts.
4-Pan: 6 quarts.

Doors: Separate rollerless sliding door per shelf.

Cord Location: Server side, bottom right corner.

OPTIONS AND ACCESSORIES – PAGE 170

WATER QUALITY REQUIREMENTS – PAGE 248

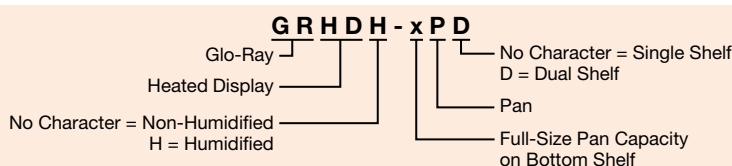



GRHD-4PD with optional pan skirts
 Top shelf: one **UPPERSKIRT-4P**
 Bottom shelf: one **SKIRT-4P**

OPTIONS (available at time of purchase only)

SKIRT-2P	Pan Skirt on bottom shelf (standard on Humidified models) 2-Pan model in lieu of Pan Rail	\$105
SKIRT-3P	Pan Skirt on bottom shelf (standard on Humidified models) 3-Pan model in lieu of Pan Rail (consists of one SKIRT-1P and one SKIRT-2P)	147
SKIRT-4P	Pan Skirt on bottom shelf (standard on Humidified models) 4-Pan model in lieu of Pan Rail (consists of two SKIRT-2P)	210
UPPERSKIRT-2P	Pan Skirt for upper shelf of 2-Pan models in lieu of Pan Stop	105
UPPERSKIRT-3P	Pan Skirt for upper shelf of 3-Pan models in lieu of Pan Stop	210
UPPERSKIRT-4P	Pan Skirt for upper shelf of 4-Pan models in lieu of Pan Stop	210
HAL	60 Watt Halogen Bulb in lieu of Standard Display Light	each 63
FLIP	Flip-Up Doors on control side in lieu of Glass Sliding Doors	No Charge
Sliding Door in lieu of Fixed Glass customer panel –		
SLIDE-2P	Per opening	\$218
SLIDE-3P	Per opening	240
SLIDE-4P	Per opening	299
Flip-Up Door in lieu of Fixed Glass customer panel –		
FLIP-2P	Per opening	\$218
FLIP-3P	Per opening	240
FLIP-4P	Per opening	299
Mirror Glass Sliding Door in lieu of Glass Sliding Door (server side only) –		
MIRROR-2P	Per opening	\$125
MIRROR-3P	Per opening	160
MIRROR-4P	Per opening	198

OPTIONS (available at time of purchase only)

Designer Colors – Non-standard colors are non-returnable – Stainless Steel standard –

RED	Warm Red	\$460
BLACK	Black	460
GRAY	Gray Granite	460
WHITE	White Granite	460
NAVY	Navy Blue	460
GREEN	Hunter Green	460
COPPER	Antique Copper	460

FOOD PANS AND TRIVETS – PAGE 240

COLORS AND FINISHES – INSIDE BACK COVER

HEATED DISPLAY CASE MAXIMUM PAN CAPACITIES*

Model	Pan Capacity	Optional Pan Skirt Frames
GRHD-2P	2 Full-Size Pans	One SKIRT-2P
GRHD-3P	3 Full-Size Pans	One SKIRT-3P
GRHD-4P	4 Full-Size Pans	One SKIRT-4P
GRHD-2PD	Top Shelf 2 Half-Size Pans or 2-14" Pizza Pans	One UPPERSKIRT-2P
	Bottom Shelf 2 Full-Size Pans	One SKIRT-2P
GRHD-3PD	Top Shelf 3 Half-Size Pans or 3-14" Pizza Pans	One UPPERSKIRT-3P
	Bottom Shelf 3 Full-Size Pans	One SKIRT-3P
GRHD-4PD	Top Shelf 2 Full-Size Pans or 4 Half-Size Pans or 4-14" Pizza Pans	One UPPERSKIRT-4P
	Bottom Shelf 4 Full-Size Pans	One SKIRT-4P

* All pan capacities shown are for non-humidified models. 2½" deep pans recommended for bottom shelf of humidified models.

Holding & Display Cabinets

*Cafeterias • Convenience Stores
Catering • Concessions*



PWC-12 in optional *Designer Black* pg. 172



FS2T-2X with accessory 4-shelf multi-purpose rack, and optional sign holder (sign not included) pg. 174



IHDC-45 with accessory risers and sign holders pg. 178



MDW-1X with optional *Designer Black* and hood with backlit sign cut out on one side (sign included) pg. 182



FS2T-1-MN shown in standard *Bronze* pg. 183



FS2C-7W1-EE shown in *Designer Black*, with optional bumper kit, and right-hand hinged door pg. 185



FS2C-17W1 with accessory food pans pg. 188



FS2HAC-2PT Pass-through with accessory food pans pg. 190



FS2HAC-15 With 1/3 size food pans (pans not included) pg. 190



Plate Warmers

Hatco's Plate Warmers are designed to hold preheated serving plates where your customers can access them easily. Countertop or Built-In models available. Easy to load and easy to clean. Serving hot food on preheated plates will help extend the holding times of most foods, and adds to a better customer experience.

- Can hold 25 plates up to 12" in diameter
- A covered, digital temperature control with an adjustable range of 104° - 122°F
- Energy efficient LED lighting illuminates the interior from the top
- Available in Stainless Steel or Designer Black powdercoating
- Cabinet cutout dimensions are: 16⁵/₈" x 20¹/₈"



PWB-12
in standard
Stainless Steel



PWC-12
in optional *Designer* Black

Digital display and power switch

Holding & Display Cabinets

Quick-Ship Model pages 241-247

PLATE WARMERS

Model	Item Number	Description	Dimensions (W x D x H)	Opening Dimensions (W x H)	Voltage	Watts	Amps	Ship Weight	List Price
Countertop									
✓ PWC-12	PWC.12SS515	Countertop, Stainless Steel	16 ⁷ / ₈ " x 17 ³ / ₈ " x 22 ³ / ₈ "*	12 ⁵ / ₈ " x 15 ³ / ₄ "	120	460	3.8	64 lbs.	\$2232
Built-In									
✓ PWB-12	PWB.12SS515	Built-In, Stainless Steel	17 ¹ / ₂ " x 17 ¹ / ₂ " x 21 ¹ / ₈ "	12 ³ / ₄ " x 15 ³ / ₄ "	120	460	3.8	49 lbs.	2018

*Height includes standard 1" legs.

All Plate Warmer Models Feature:

Models Shipped with:

PWC-12: Power On/Off switch, a detachable 6' power cord, a 3' jumper cord and a wall-mounting kit, NEMA 5-15P plug.

PWB-12: Power On/Off switch, a detachable 6' power cord and a 3' jumper cord, NEMA 5-15P plug.

Cabinet cut-out dimensions for PWB-12: 16⁵/₈" W x 20¹/₈" H.

Cord Location: back of unit, top left corner.

OPTIONS (available at time of purchase only)

Designer Color – Non-standard colors are non-returnable – Stainless Steel Standard –
BLACK Designer Black **\$398**

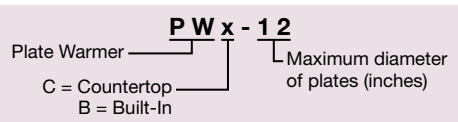

Flav-R-Fresh® Humidified Impulse Display Cabinets

A profitable way to create impulse food sales is with the small Flav-R-Fresh® Holding and Display Cabinet. Using controlled moisturized heat allows you to showcase your product longer using minimum counter space.

- Full-view display with tempered glass sides and door
- Controlled heat and humidity for longer holding times
- Accommodates half-size sheet pans
- Revolving or stationary display racks
- Single- or reversible double-sided opening models
- LED lights illuminate the holding areas and emphasize the product



FDWD-2 with accessory 4-tier circle rack

Quick-Ship Model pages 241-247

IMPULSE CABINETS

Model*	Description*	Dimensions W x D x H*	Cabinet Opening W x H	Voltage Single Phase	Watts	Ship Weight	List Price ⁹
✓ FDWD-1	1 Door w/4-Tier Circle Rack w/Motor	19 ³ / ₈ " x 20 ⁷ / ₈ " x 28 ⁷ / ₈ "	15 ³ / ₄ " x 19 ³ / ₄ "	120	1360	90 lbs.	\$4054
✓ FDWD-1X	1 Door w/4-Shelf Multi-Purpose Rack w/o Motor	19 ³ / ₈ " x 20 ⁷ / ₈ " x 28 ⁷ / ₈ "	15 ³ / ₄ " x 19 ³ / ₄ "	120	1360	90 lbs.	3930
✓ FDWD-2	2 Doors w/4-Tier Circle Rack w/Motor	19 ³ / ₈ " x 22" x 28 ⁷ / ₈ "	15 ³ / ₄ " x 19 ³ / ₄ "	120	1360	90 lbs.	4181
FDWD-2X	2 Doors w/4-Shelf Multi-Purpose Rack w/o Motor	19 ³ / ₈ " x 22" x 28 ⁷ / ₈ "	15 ³ / ₄ " x 19 ³ / ₄ "	120	1360	90 lbs.	4050

- Models FDWD-1 and FDWD-2 include rack motor. Models with "X" designator do not have revolving display and are NOT available for retrofit.
- Rack listed is included with unit. Other racks available – deduct price of included rack and add price of substituted rack to list price.
- Height includes standard 1" legs.
- For non-humidified cabinet, deduct \$210. Unit will only operate in dry mode.

All Impulse Cabinet Models Feature:

Voltage: 60 Hz, 11.3 amps, NEMA 5-15P plug.
Door Hinges – Control Side and Customer Side (two-door models only): Left-hand side.
Max. Pizza Size: 15" diameter with 4-Tier Circle Rack.
Water Tank Capacity for Humidity System: ½ gallon.
Cord Location: Facing controls, left-hand side panel, lower right corner.

WATER QUALITY REQUIREMENTS – PAGE 248

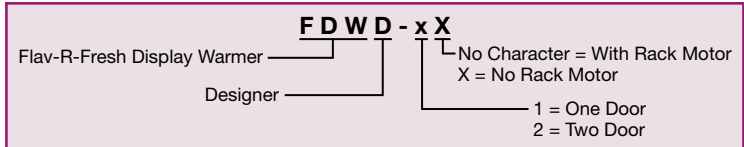

OPTIONS (available at time of purchase only) (not available on Quick-Ship)

Designer Colors – Non-standard colors are non-returnable – Clear Anodized Aluminum Standard –		
RED	Warm Red	\$460
BLACK	Black	460
GRAY	Gray Granite	460
WHITE	White Granite	460
NAVY	Navy Blue	460
GREEN	Hunter Green	460
COPPER	Antique Copper	460
LED-NW18	Neutral White (cool) LED lighting (in lieu of standard Warm White)	No Charge
FDWD-SCD	Self Closing Door in lieu of standard door (left hinge only). Must upgrade both doors on FDWD-2, -2X (not field reversible)	per door \$ 84
FDWD-6FRT	6" Merchandising Display Sign Holder for Control Side only (Includes metal holder only). Available in all Designer Colors to match your unit (Black is standard). Adds 1 1/8" to height of unit. Requires (1) sign 19 7/16"W x 6 1/16"H x 1/16"D – not included	113
FDWD-DIS	3" One Sided Merchandising Display Sign Holder (includes metal holder and window) – one per side, three maximum. Available in all Designer Colors to match your unit (Black is standard). Adds 1 1/4" to height of unit. Requires (1) sign 19 1/16"W x 3 3/4"H x 1/16"D – not included	80
FDWD-6SIGN	6 3/8" One-Sided Merchandising Display Sign Holder (includes metal holder and window) – one per side, three maximum. Available in all Designer Colors to match your unit (Black is standard). Adds 1 1/4" to height of unit. Requires (1) sign 19 7/16"W x 6 1/4"H x 1/16"D – not included	88

ACCESSORIES (available for purchase at any time)

FDWD-LEGS	4" Adjustable Legs (4" - 5")	\$ 84
COUPLING	Motorless Rack Coupling for FDWD-1X and FDWD-2X models (select Circle Rack or Pretzel Tree)	46
FDWD4TCRR	4-Tier Circle Rack with Pizza Pan Retainers (Requires Coupling for -1X or -2X models)	251
FDW4SMP	4-Shelf Multi-Purpose Rack (each shelf 13 3/8"W x 12 3/8"D)	284
FDW3TPT	3-Tier Pretzel Tree (requires Coupling for -1X or -2X models)	284
FDW3SAR	3-Shelf Angle Rack	588

- DECORATIVE KIT – PAGE 176**
- RACKS – PAGE 177**
- FOOD PANS AND TRIVETS – PAGE 240**
- COLORS AND FINISHES – INSIDE BACK COVER**



COUPLING
Accessory

Holding & Display Cabinets

Flav-R-Savor® Humidified Holding & Display Cabinets

Balancing a precise combination of heat and humidity, the Hatco Flav-R-Savor® Cabinets provide an attractive showcase for hot food displays and generate impulse sales. A complete range of cabinet sizes, door options and rack types allows for perfect merchandising of food products such as pizza, fried foods, bakery items, sandwiches and more.

- Full-view display with tempered glass sides and door provide maximum heat retention
- Controlled heat and humidity for longer holding times
- ¾ gallon stainless steel water reservoir provides all day moisture
- Low-water protection prevents heating element burnout and alerts operator to low-water condition
- Revolving or stationary display racks
- Available in two heights with single-sided or double-sided openings
- Energy efficient LED lighting to illuminate your food display



FSD-1 with 3-tier pan rack and accessory food pans



FSDT-2 with 4-tier circle rack and 4" legs, optional Designer Black color and accessory food pans

Quick-Ship Model pages 241-247

DISPLAY CABINETS

Model*	Description ^o	Dimensions W x D x H	Ship Weight	List Price ^o
Standard				
✓ FSD-1	1 Door w/3-Tier Circle Rack w/Motor	22½" x 24½" x 27½"	129 lbs.	\$5078
✓ FSD-1X	1 Door w/3-Tier Pan Rack w/o Motor	22½" x 24½" x 27½"	126 lbs.	4926
FSD-2	2 Doors w/3-Tier Circle Rack w/Motor	22½" x 25¾" x 27½"	126 lbs.	5423
FSD-2X	2 Doors w/3-Tier Pan Rack w/o Motor	22½" x 25¾" x 27½"	126 lbs.	5274
Tall				
✓ FSDT-1	1 Door w/4-Tier Circle Rack w/Motor	22½" x 24½" x 32½"	128 lbs.	\$5163
✓ FSDT-1X	1 Door w/4-Tier Pan Rack w/o Motor	22½" x 24½" x 32½"	126 lbs.	4961
FSDT-2	2 Doors w/4-Tier Circle Rack w/Motor	22½" x 25¾" x 32½"	126 lbs.	5573
FSDT-2X	2 Doors w/4-Tier Pan Rack w/o Motor	22½" x 25¾" x 32½"	126 lbs.	5374

* Models FSD-1, FSD-2, FSDT-1 and FSDT-2 include rack motor. Models with "X" designator do not have revolving display and are NOT available for retrofit.
^o Rack listed is included with unit. Other racks available – deduct price of included rack and add price of substituted rack to list price.
^o For non-humidified cabinet, deduct \$210. Unit will only operate in dry mode.

All Models Feature:

Voltage: 120, single phase, 60 Hz, 1414 watts, 11.8 amps, NEMA 5-15P plug.

Cabinet Opening Dimensions: Standard Models: 19"W x 18½"H.

Tall Models: 19"W x 23¾"H.

Door Hinges: Control Side: Left-hand side.

Customer Side (two-door models only): Right-hand side.

Max. Pan Size: 19" diameter with 4-Tier Circle Rack.

Water Tank Capacity for Humidity System: ¾ gallon.

Cord Location: Facing controls, left-hand side panel, lower right corner.

OPTIONS AND ACCESSORIES – PAGE 175

DECORATIVE KIT – PAGE 176

RACKS – PAGE 177

FOOD PANS AND TRIVETS – PAGE 240

WATER QUALITY REQUIREMENTS – PAGE 248

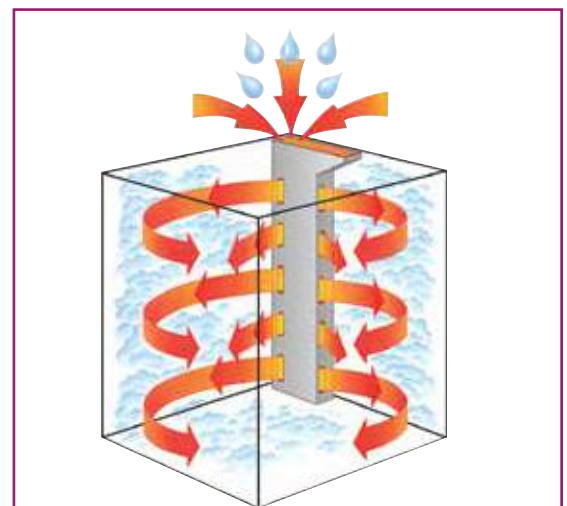

CONTROLLED MOISTURIZED HEAT KEEPS HOT FOODS FRESH LONGER Hatco's Flav-R-Savor® air flow pattern is designed to maintain consistent cabinet temperature without drying out foods. The precise combination of heat and humidity creates a "blanket" effect around the food. The air flow rate enables the cabinet to recover temperature rapidly after opening and closing the door.

FSDT - x X

Flav-R-Savor Display Cabinet ————
 No Character = Standard Height
 T = Tall
 No Character = With Rack Motor
 X = No Rack Motor
 1 = One Door
 2 = Two Door



Two FSDT-1 with 4-tier circle racks, optional sign holders (signs not included) and accessory food pans

OPTIONS (available at time of purchase only) (not available on Quick-Ship)

LED-NW18	Neutral White (cool) LED lighting (in lieu of standard Neutral White)	No Charge
THERM	Mechanical Controls	No Charge
FSD7SIGN	7½" Merchandising Display Sign Holder (includes metal holder and window) – one per side , three maximum. Available in all <i>Designer Colors</i> to match your unit (Black is standard). Adds 1¼" to height of unit. Requires (1) sign 22½"W x 7½"H x ¼"D – not included	\$92

ACCESSORIES (available for purchase at any time)

F-LEGS-4	4" Adjustable Legs	\$84
COUPLING	Motorless Rack Coupling for FSD-1X, FSD-2X, FSDT-1X and FSDT-2X models (select appropriate Circle Rack or Pretzel Tree)	46

RACKS – FSD ONLY –

FSD5SMP	5-Shelf Multi-Purpose Rack (each shelf - 18"W x 16"D)	\$382
FSD3TCR	3-Tier Circle Rack with Pizza Pan Retainers (requires Coupling for -1X or -2X models)	234
FSD3TPR	3-Tier Pan Rack (accommodates Half-Size Sheet Pans, not included)	338

RACKS – FSDT ONLY –

FSDT7SMP	7-Shelf Multi-Purpose Rack (each shelf - 18"W x 16"D)	\$468
FSDT4TCR	4-Tier Circle Rack with Pizza Pan Retainers (requires Coupling for -1X or -2X models)	249
FSDT5TCR	5-Tier Circle Rack with Pizza Pan Retainers (requires Coupling for -1X or -2X models)	378
FSDT4TPR	4-Tier Pan Rack (accommodates Half-Size Sheet Pans, not included)	299
FSDT3SAR	3-Shelf Angle Rack (15° angle shelves) (each shelf - 18"W x 16¼"D)	863
FSDT3TPT	3-Tier Pretzel Tree (requires Coupling for -1X or -2X models)	408

DECORATIVE KIT – PAGE 176

RACKS – PAGE 177

FOOD PANS AND TRIVETS – PAGE 240

COLORS AND FINISHES – INSIDE BACK COVER

OPTIONS (available at time of purchase only) (not available on Quick-Ship)

Designer Colors

– *Non-standard colors are non-returnable*

– *Clear Anodized Aluminum Standard –*

RED	Warm Red	\$460
BLACK	Black	460
GRAY	Gray Granite	460
WHITE	White Granite	460
NAVY	Navy Blue	460
GREEN	Hunter Green	460
COPPER	Antique Copper	460

Decorative Kit for FDWD, FSD, FSDT models only

Transform your Hatco Flav-R-Savor® Holding & Display Cabinet from a "heated box" into a *Designer Merchandiser* with a variety of simple accessory additions. Create a new look and feel to your decór.

- The curved hinged header allows easy access to controls and water fill cup, and gives a great area to brand your food product with a magnetic sign (sign not included)
- The base skirt completes the transformation and gives an additional branding area. Available in flat or curved panels for front and/or back of unit
- Signs can be decals or magnetic
- Signs not included

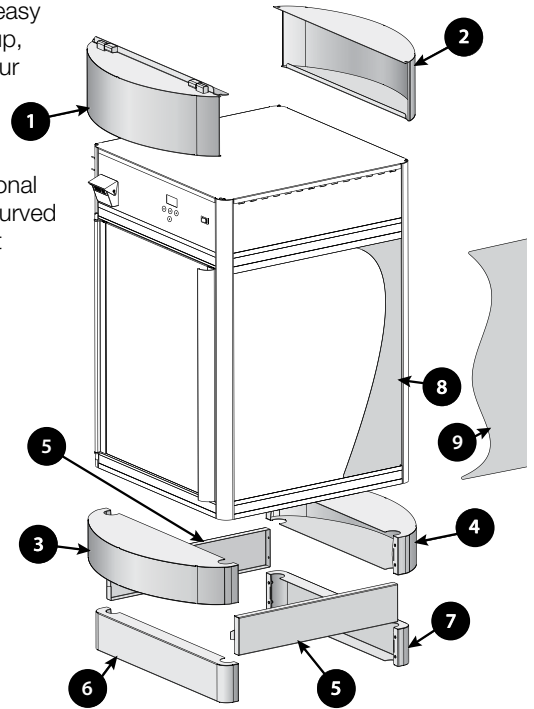

OPTIONS (available at time of purchase only) (not available on Quick-Ship) (additional lead time required)

Designer Colors – Non-standard colors are non-returnable – Black Standard –			
RED	WR	Warm Red	No Charge
GRAY	GG	Gray Granite	No Charge
WHITE	WG	White Granite	No Charge
NAVY	NB	Navy Blue	No Charge
GREEN	HG	Hunter Green	No Charge
COPPER	AC	Antique Copper	No Charge

ACCESSORIES (available for purchase at any time)

Side Insets – Must choose Designer Color – Black Standard –

FSD-INSET1	Two Crescent Inset Panels for FSD models	\$91
FSD-INSET2	Two Wave Inset Panels for FSD models	91
FSDT-INSET1	Two Crescent Inset Panels for FSDT models	91
FSDT-INSET2	Two Wave Inset Panels for FSDT models	91
FDWD-INSET1	Two Crescent Inset Panels for FDWD models	91
FDWD-INSET2	Two Wave Inset Panels for FDWD models	91

Top Covers – Must choose Designer Color – Black Standard – Signs not Included –

FSD-CTLH	Curved Hinged Header on control side (Fits 24"W x 5 ⁷ / ₈ "H sign) for FSD and FSDT models	\$316
FDWD-CTLH	Curved Hinged Header on control side (Fits 20 ¹ / ₂ "W x 4 ⁷ / ₈ "H sign) for FDWD models	269
FSD-CUSH	Curved Header on non-control side (Fits 24"W x 5 ⁷ / ₈ "H sign) for FSD and FSDT models	230
FDWD-CUSH	Curved Header on non-control side (Fits 20 ¹ / ₂ "W x 4 ⁷ / ₈ "H sign) for FDWD models	197

Base Skirts – Requires 4" adjustable legs (not included) – Must choose Designer Color – Black Standard – Signs not Included –

FSD-SQB	One Flat Front Panel 6 and one Flat Back Panel 7 (Fits 20"W x 3 ⁵ / ₈ "H sign) and two Flat Side Panels 5 (Fits 18 ³ / ₈ "W x 3 ⁵ / ₈ "H sign) for FSD and FSDT models	\$273
FDWD-SQB	One Flat Front Panel 6 and one Flat Back Panel 7 (Fits 17 ¹ / ₄ "W x 3 ³ / ₄ "H sign) and two Flat Side Panels 5 (Fits 15 ¹ / ₂ "W x 3 ³ / ₄ "H sign) for FDWD models	355
FSD-1CB	One Curved Front Panel 3 and one Flat Back Panel 7 (Fits 25 ¹ / ₂ "W x 3 ⁵ / ₈ "H sign) and two Flat Side Panels 5 (Fits 18 ³ / ₈ "W x 3 ⁵ / ₈ "H sign) for FSD and FSDT models	489
FDWD-1CB	One Curved Front Panel 3 and one Flat Back Panel 7 (Fits 22 ¹ / ₄ "W x 3 ³ / ₄ "H sign) and two Flat Side Panels 5 (Fits 15 ¹ / ₂ "W x 3 ³ / ₄ "H sign) for FDWD models	475
FSD-2CB	One Curved Front Panel 3 and one Curved Back Panel 4 (Fits 25 ¹ / ₂ "W x 3 ⁵ / ₈ "H sign) and two Flat Side Panels 5 (Fits 18 ³ / ₈ "W x 3 ⁵ / ₈ "H sign) for FSD and FSDT models	704
FDWD-2CB	One Curved Front Panel 3 and one Curved Back Panel 4 (Fits 22 ¹ / ₄ "W x 3 ³ / ₄ "H sign) and two Flat Side Panels 5 (Fits 15 ¹ / ₂ "W x 3 ³ / ₄ "H sign) for FDWD models	599
F-LEGS-4	4" Adjustable Legs for FSD and FSDT models	\$84
FDWD-LEGS	4" Adjustable Legs for FDWD models	84

COLORS AND FINISHES – INSIDE BACK COVER



FSDT-1 with 4-tier circle rack and full Decorative Kit (signs not included)

Display Rack Selections

Racks For FDWD Models (Page 173)

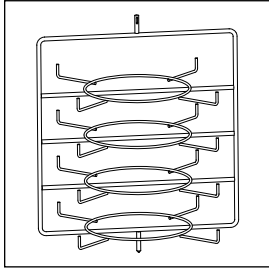

4-Tier Circle Rack
FDWD4TCRR
(Max. 15" dia. pans)
(3/4" between tiers)

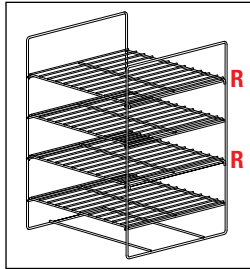

4-Shelf Multi-Purpose Rack
FDW4SMP (Max. 18" x 13")
(Half-Size Sheet Pans fit
FDWD-2 and -2X models only)
(3/4" between shelves)

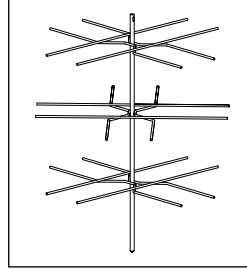

3-Tier Pretzel Tree
FDW3TPT
(5/8" between tiers)

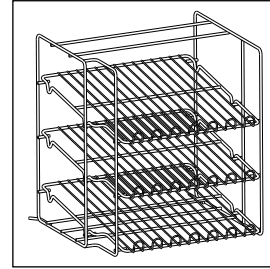

3-Tier Angle Rack
FDW3SAR
(5/8" between tiers)

Racks For FSD Models (Page 174)

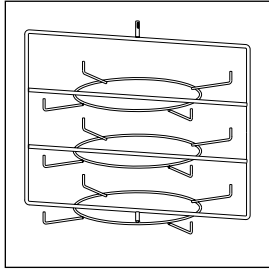

3-Tier Circle Rack
FSD3TCR
(4 5/8" between tiers)

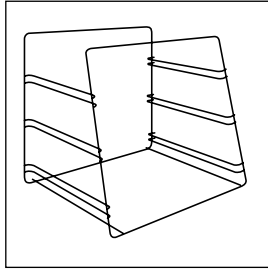

3-Tier Pan Rack
FSD3TPR
(3/2" between shelves)

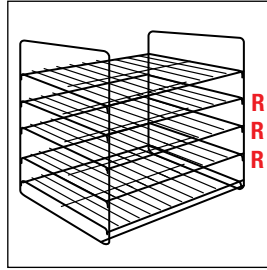

5-Shelf Multi-Purpose Rack
FSD5SMP
(2 1/2" between shelves)

Racks For FSDT Models (Page 174)

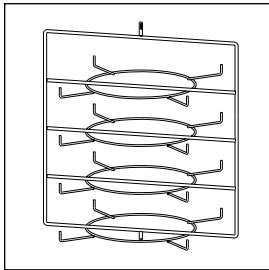

4-Tier Circle Rack
FSDT4TCR
(Max. 19" dia. pans)
(4 5/8" between tiers)

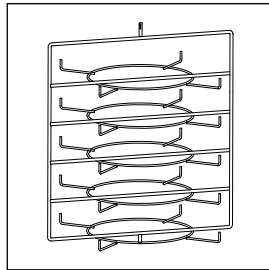

5-Tier Circle Rack
FSDT5TCR
(Max. 19" dia. pans)
(3 7/8" between tiers)

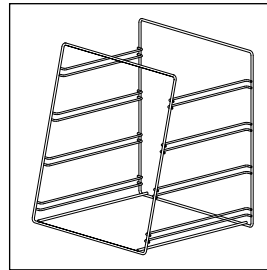

4-Tier Pan Rack
FSDT4TPR
(Max. 18" x 13" Half-Size Sheet
Pans) (3 1/2" between tiers)

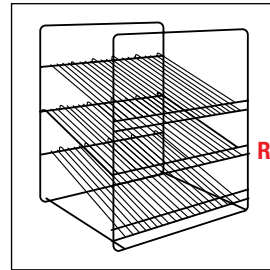

3-Shelf Angle Rack
FSDT3SAR
(3 1/2" between shelves)

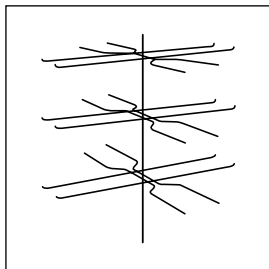

3-Tier Pretzel Tree
FSDT3TPT
(5 7/8" between tiers)

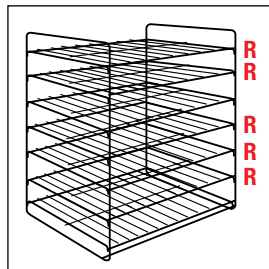

7-Shelf Multi-Purpose Rack
FSDT7SMP
(Max. 18" x 13" Half-Size Sheet
Pans) (2 1/2" between shelves)

R Removable Shelves



Intelligent Heated Display Cabinet, Humidified

Hatco's Intelligent Heated Display Cabinet Humidified is the perfect way to showcase your pizzas and more. Regulating air temperature while at the same time balancing the humidity levels provides the best environment for food products. With 360° viewing, your food is guaranteed to get all the attention.

- Air flow pattern is designed to maintain consistent cabinet temperature without drying out food
- Air flow system enables the cabinet to recover temperature rapidly after opening and closing the door
- LCD touchscreen display on back of unit controls temperature, humidity and up to eight timers for each food location
- Energy efficient LED lighting to illuminate your food display
- USB port on back of unit makes it easy to update firmware
- Adjustable arms can move up and down the back supports
 - IHDCH-45 can hold up to six pizza arms, can be adjusted up to 19.5" and can hold up to 8.5 lbs.
 - IHDCH-28 arms will hold up to a 22" pizza pan



IHDCH-45 shown with three optional shelves and French Front Doors



IHDCH-45 shown with accessory arms and risers



IHDCH-28 shown with accessory two arms and one shelf

NOTE: Water filter, water strainer and plastic tubing are included with each cabinet to be installed on water supply connection.

INTELLIGENT HEATED DISPLAY CABINETS – HUMIDIFIED

Model	Dimensions W x D x H	Cabinet Opening Dimensions (W x H)	Voltage	Watts	Amps	Plugs	Ship Weight	List Price
IHDCH-28	28¼" x 28¾" x 30¼"	22" x 20⅝"	208 240	3090	14.9 or 12.9	NEMA 6-20P	220 lbs.	\$11673
IHDCH-45	45" x 28¾" x 30¼"	18" x 20⅝"	208 240	3090	14.9 or 12.9	NEMA 6-20P	270 lbs.	12470

All Intelligent Heated Display Cabinet Models Feature:

Models Shipped With: IHDCH-28: Stainless Steel unit with single french door, touchscreen controller, a lighted Power On/Off (I/O) switch, an air heating/circulation system, a humidity system, a USB port and LED display lights.

IHDCH-45: Stainless Steel unit with sliding glass doors, touchscreen controller, a lighted Power On/Off (I/O) switch, an air heating/circulation system, a humidity system, a USB port and LED display lights.

Cord Location: Server side, lower left corner.

OPTIONS AND ACCESSORIES – PAGE 179
WATER QUALITY REQUIREMENTS – PAGE 248



On all Intelligent Heated Display Cabinet Models customers must purchase arms and shelves separately to their own specifications.

Below are the options available to combine the shelves and arms

IHDCH-28	IHDCH-45
4 Arms	6 Arms
2 Shelves	3 Slanted Shelves
1 Shelf with 1 Pizza Arm	1 Shelf with 2 Pizza Arms
1 Shelf with 2 Pizza Arms	1 Shelf with 4 Pizza Arms
2 Shelves with 1 Pizza Arm	2 Shelves with 2 Pizza Arms



IHDC-45 shown with accessory arms, accessory risers and sign holders

OPTIONS (available at time of purchase only)

Designer Colors – Non-standard colors are non-returnable – Stainless Steel Standard –

IHDCH-BK	Unit in <i>Designer Black</i> in lieu of Stainless Steel unit	\$ 460
IHDCHBASE-BK-28	Inside base in <i>Designer Black</i> in lieu of Stainless Steel base for IHDC-28	27
FRDOR-28	Front, swing out door for IHDC-28, left-hand hinge standard, matches unit color (adds 2" to depth)	884
IHDCHBASE-BK-45	Inside base in <i>Designer Black</i> in lieu of Stainless Steel base for IHDC-45	34
FRFRDOR-45	Front, self-closing French doors for IHDC-45, matches unit color (adds 2" to depth)	1675

ACCESSORIES (available for purchase at any time)

ADJARM-SS-28	Adjustable Arm in Stainless Steel for IHDC-28	each \$ 182
ADJARM-BK-28	Adjustable Arm in <i>Designer Black</i> for IHDC-28	each 221
SHELF-SS-28	Shelf in Stainless Steel for IHDC-28	each 246
SHELF-BK-28	Shelf in <i>Designer Black</i> for IHDC-28	each 246
ADJARM-SS-45	Adjustable Arm in Stainless Steel for IHDC-45	each 182
ADJARM-BK-45	Adjustable Arm in <i>Designer Black</i> for IHDC-45	each 221
SHELF-SS-45	Shelf in Stainless Steel for IHDC-45	each 362
SHELF-BK-45	Shelf in <i>Designer Black</i> for IHDC-45	each 627
RISER12-SS	12" diameter x 1½" H Riser in Stainless Steel	28
RISER12-BK	12" diameter x 1½" H Riser in <i>Designer Black</i>	40
DOORLOCKIHDCH	Front Door lock for IHDC-28 only	25
RO KIT	Reverse Osmosis System with storage tank	1663
REGKIT	Water Pressure Regulator Kit (regulator, gauge and shut-off valve)	383

SIGN HOLDERS (signs not included) – recommended sign size: 2" x 3.5" –

SGNHOLD-BASE-SS	Sits on base of unit in Stainless Steel	each \$18
SGNHOLD-BASE-BK	Sits on base of unit in <i>Designer Black</i>	each 33
SGNHOLD-LARM-SS	Customer left-hand side in Stainless Steel (clips onto Arm)	each 20
SGNHOLD-LARM-BK	Customer left-hand side in <i>Designer Black</i> (clips onto Arm)	each 38
SGNHOLD-RARM-SS	Customer right-hand side in Stainless Steel (clips onto Arm)	each 20
SGNHOLD-RARM-BK	Customer right-hand side in <i>Designer Black</i> (clips onto Arm)	each 38

FOOD PANS AND TRIVETS – PAGE 240
COLORS AND FINISHES – INSIDE BACK COVER

Flav-R-Savor® Humidified Large Capacity Display Cabinets

Hatco Large Capacity Holding Cabinets hold more product at proper serving temperatures than standard size models. This allows for food to be prepared in advance of peak serving periods, while placing product in full-view cabinets to increase impulse sales.

- Full-view display with tempered glass sides and LED lighting to illuminate holding area
- Optional self-closing sliding doors for self-serve applications

- Optional self-closing French doors,
- Optional cool LED lighting and 4" adjustable legs available
- Multi-purpose display racks included



WFST-2X with 4-shelf multi-purpose rack, optional *Designer Warm Red*, self-closing sliding doors and accessory food pans, and 4" legs



WFST-1X with 4-shelf multi-purpose rack. Decals and pans not included

WIDE HOLDING CABINETS

Model	Description	Dimensions W x D x H	Voltage	Watts	Amps	Plugs [▲]	Ship Weight	List Price
WFST-1X	2 Doors w/4-Shelf Rack	32 ¹ / ₈ " x 25 ¹ / ₄ " x 32 ³ / ₄ "	120 or 120/208-240	1715 or 2315	14.3	NEMA 5-15P	182 lbs.	\$8967
WFST-2X	4 Doors w/4-Shelf Rack	32 ¹ / ₈ " x 27 ³ / ₈ " x 32 ³ / ₄ "	120 or 120/208-240	1715 or 2315	14.3	NEMA 5-15P	188 lbs.	9583

▲ Canadian models use NEMA 5-20P.

All Large Capacity Cabinet Models Feature:

Cabinet Opening Dimensions: 28"W x 21⁷/₈"H.

Available Shelf Space: 26³/₄"W x 19³/₄"D. Holds one full-size sheet pan per shelf.

Water Tank Capacity for Humidity System: ³/₄ gallon.

Cord Location: Server side, left-hand side panel, lower right corner.

WATER QUALITY REQUIREMENTS – PAGE 248

OPTIONS (available at time of purchase only)

Designer Colors – Non-standard colors are non-returnable –
– Clear Anodized Aluminum Standard –

RED	Warm Red	\$460
BLACK	Black	460
GRAY	Gray Granite	460
WHITE	White Granite	460
NAVY	Navy Blue	460
GREEN	Hunter Green	460
COPPER	Antique Copper	460
1SLIDE-DR	Self-closing Sliding Doors in lieu of standard Hinged Doors on one side only (WFST-2X only)	\$484
FRSELFCL	Self-Closing French Doors	per side 149
WFST-TTC	Temperature Control Timer - 6 channel control touchscreen display	573
LED-NW18	Neutral White (cool) LED lighting (in lieu of standard Warm White)	No Charge

ACCESSORIES (available for purchase at any time)

FSTCR-LEG	4" Adjustable Legs	\$81
------------------	--------------------	-------------

FOOD PANS AND TRIVETS – PAGE 240

COLORS AND FINISHES – INSIDE BACK COVER

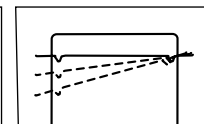
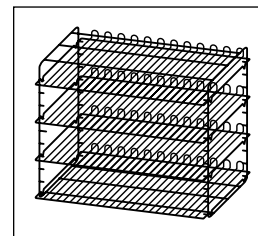

WFST 4-Shelf Multi-Purpose Rack
Adjustable Shelves in 2" increments



Flav-R-Savor® Non-Humidified Large Capacity Display Cabinets

When capacity is an issue, Hatco's Large Capacity Holding Cabinet is perfect for wrapped or bagged product. Designed to hold prepared foods for prolonged periods of time, while maintaining that "just-made" quality, allows for advanced preparation of peak serving periods.

- Countertop cabinets with self-closing French-style glass doors
- Standard sign holders on all four sides of the cabinet (signs not included)
- Full-view display with tempered glass sides and incandescent lights to illuminate holding area
- Multi-purpose display rack included
- Perfect for large quantities of wrapped or boxed food
- Holds two standard sheet pans side-by-side on three shelves for increased product visibility and easy accessibility

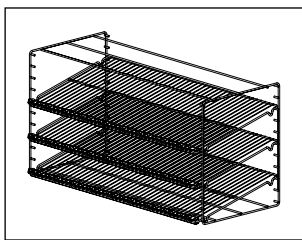

LFST 3-Shelf Multi-Purpose Rack with adjustable shelves in 2" increments

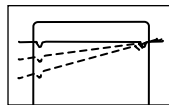

LFST-48-2X with 3-shelf multi-purpose rack, sign holders (signs not included) and optional *Designer* Warm Red

LARGE CAPACITY HOLDING CABINETS – NON-HUMIDIFIED

Model*	Bulbs	Description	Dimensions W x D x H	Plug	Ship Weight	List Price
LFST-48-1X	6	Front Glass, Back French Doors	48 ⁷ / ₈ " x 25 ³ / ₈ " x 30"	NEMA L14-20P	222 lbs.	\$11866
LFST-48-2X	6	Front and Back French Doors	48 ⁷ / ₈ " x 27 ¹ / ₈ " x 30"	NEMA L14-20P	230 lbs.	12534

* When no color is specified, unit will be Black.

All Wide Cabinet Models Feature:

Voltage: 120/208-240, 2150 watts, 14.6 amps.

Cabinet Opening Dimensions: 44"W x 22"H.

Available Shelf Space: 41³/₄"W x 17"D. Holds three, half-size sheet pans per shelf.

Cord Location: Server side, left-hand side panel, lower right corner.

OPTIONS (available at time of purchase only)

Designer Colors – Non-standard colors are non-returnable – Black Standard –

CLEAR	Clear Anodized Aluminum	No Charge
RED	Warm Red	No Charge
GRAY	Gray Granite	No Charge
WHITE	White Granite	No Charge
NAVY	Navy Blue	No Charge
GREEN	Hunter Green	No Charge
COPPER	Antique Copper	No Charge
HAL	60 Watt Halogen Bulb in lieu of Standard Display Light	each \$63

FOOD PANS AND TRIVETS – PAGE 240

COLORS AND FINISHES – INSIDE BACK COVER

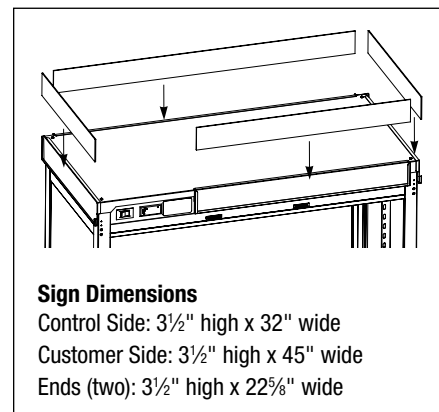

Sign Dimensions

Control Side: 3¹/₂" high x 32" wide
 Customer Side: 3¹/₂" high x 45" wide
 Ends (two): 3¹/₂" high x 22⁵/₈" wide

LFST Cabinet comes with sign holders attached on all four sides, with clear plastic inserts (signs not included)





Non-Humidified Mini Display Warmers

The Hatco Mini Display Warmer is perfect for cookies, pastries, wrapped or boxed sandwiches or any other product that does not require humidity. Hot air circulates throughout the entire cabinet, keeping food at safe serving temperatures. The small footprint takes up little of your valuable counterspace while merchandising your breakfast, lunch or dinner offerings.

- Magnetically adjustable shelves allow horizontal or slanted displays
- Tempered glass sides and incandescent light
- Available as a 1- or 2-door pass-through model

- Doors may be field converted to any side
- Optional black hood with backlit graphic sign cutout that can be rotated in field to face any side (sign included)

MDW-1X with standard Designer Black and optional Hood with backlit sign cutout on one side (sign included)



Magnetically adjustable shelves are easy and offer quick adjustability for different food products

MINI DISPLAY WARMERS – NON-HUMIDIFIED

Model	Description	Dimensions W x D x H	Voltage	Watts	Amps	Plug	Ship Weight	List Price
MDW-1X	1 Door w/3 Shelves	15¾" x 17" x 25½"	120	470	3.9	NEMA 5-15	46 lbs.	\$2559
MDW-2X	2 Doors w/3 Shelves	15¾" x 18¾" x 25½"	120	470	3.9	NEMA 5-15	53 lbs.	2660

All Mini Display Warmer Models Feature:

Cabinet Opening Dimensions: 12½"W x 15½"H.

Door Hinges: Control Side: Left-hand side.

Customer Side (two-door models only): Right-hand side.

Cord Location: Server side, lower right corner.

OPTIONS (available at time of purchase only)

Designer Color for Posts, Base, and Top Trim – Non-standard colors are non-returnable – Black Standard –

RED	Warm Red	No Charge
GRAY	Gray Granite	No Charge
WHITE	White Granite	No Charge
NAVY	Navy Blue	No Charge
GREEN	Hunter Green	No Charge
COPPER	Antique Copper	No Charge
BCKLIT-MDW	Hood with Backlit Sign cut out on one side - Black only (sign included)	\$131

COLORS AND FINISHES – INSIDE BACK COVER

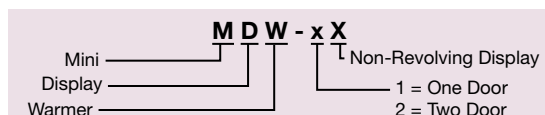

Non-Humidified Macho Nacho® Chip Warmers

Keep your nacho chips hot, fresh and crisp with Hatco's Macho Nacho® Chip Warmer. This highly-visible heated merchandiser circulates air to prevent the loss of natural oils, eliminating the need to frequently replace stale chips.

- Keeps chips hot, fresh and crisp longer, reducing refill time and minimizing waste
- Specialty cabinets to hold and/or merchandise bulk nacho chips
- Special ductwork forces dry heat through chips from the bottom up
- Special two-door access for easy loading and serving
- 25 lb. or 40 lb. capacity
- Shatter-resistant incandescent lights illuminate the holding areas and emphasize the product



Holding & Display Cabinets

CHIP WARMERS – NON-HUMIDIFIED

Model	Dimensions W x D x H	Product Capacity	Voltage	Watts	Plug	Ship Weight	List Price
FDWD-1-MN	19 ³ / ₈ " x 24" x 28 ⁷ / ₈ "	25 lbs.	120	1080	NEMA 5-15P	101 lbs.	\$4009
FST-1-MN	22 ⁷ / ₈ " x 27" x 32 ⁷ / ₈ "	40 lbs.	120	1245	NEMA 5-15P	132 lbs.	5604

All Chip Warmer Models Feature:

Cabinet Opening: FDWD-1-MN: Upper Door: 16³/₈"W x 9³/₈"H.
 Lower Door: 16³/₈"W x 9³/₈"H.
 FST-1-MN: Upper Door: 18³/₈"W x 11¹/₄"H.
 Lower Door: 18³/₈"W x 9³/₈"H.

Decal Size: FDWD-1-MN: 16³/₈"W x 5¹/₂"H.
 FST-1-MN: 18³/₈"W x 6"H.

Cord Location: Facing controls, left-hand side panel, lower right corner.

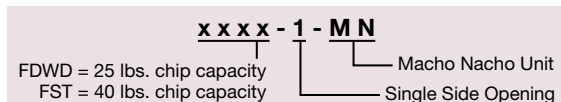

Flav-R-Savor® Tall Non-Humidified Holding Cabinets

Be prepared to serve ready-to-go pizzas with Hatco's Flav-R-Savor® Tall Dry Holding Cabinets. An eight-shelf rack with 5" centers will hold a maximum of 16 boxed (18" Sq x 2⁵/₁₆"H maximum) or 8 bagged pizzas.

- Great for boxed or bagged carryout pizzas
- Tempered glass throughout for excellent visibility, improving product rotation
- Even, constant cabinet temperatures with no humidity
- Two, shatter-resistant, incandescent lights at the back top of the unit to illuminate product
- Units come with an eight-shelf rack, six of which are removable



PFST-2X with standard stainless steel 8-shelf rack



PFST-1XB with standard Glossy White 8-shelf rack

Holding & Display Cabinets

TALL HOLDING CABINETS – NON-HUMIDIFIED

Model	Description	Dimensions W x D x H	Opening Dimensions W x H	Voltage	Watts	Plug	Ship Weight	List Price
Standard								
PFST-1X	1 Door	22 ⁷ / ₈ " x 25" x 57"	18 ³ / ₄ " x 40 ³ / ₈ "	120	1767	NEMA 5-15P	200 lbs.	\$7585
PFST-2X	2 Doors	22 ⁷ / ₈ " x 27 ¹ / ₄ " x 57"	18 ³ / ₄ " x 40 ³ / ₈ "	120	1767	NEMA 5-15P	207 lbs.	7983
With Base								
PFST-1XB	1 Door	24 ³ / ₄ " x 25 ¹ / ₂ " x 70"	18 ³ / ₄ " x 40 ³ / ₈ "	120	1767	NEMA 5-15P	258 lbs.	\$7866

Canadian models use NEMA 5-20P.

All Tall Dry Holding Cabinet Models Feature:

Models Shipped with: **PFST-1X, -2X:** Stainless Steel body, an eight-shelf rack with 6 removable shelves in standard stainless steel, new latching handle, 5" locking casters, cord and plug.

PFST-1XB: Solid back panel, stainless steel inside, (with painted Glossy Gray on the outside), an eight-shelf rack with 6 removable shelves in standard Smooth White, front and side sign holders painted Glossy Gray with flip-up side for access to controls (signs not included), 11" high Designer Black base, latching handle, 4" locking casters, cord and plug.

Available Shelf Space: 18" square x 4⁵/₈" height.

Cord Location: Facing controls, left-hand side panel, bottom right corner.

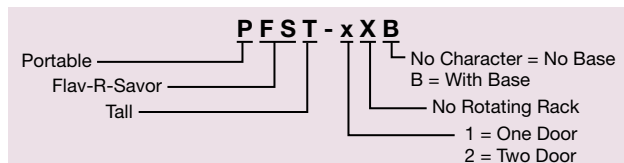

OPTIONS (available at time of purchase only)

**Designer Color – Non-standard colors are non-returnable –
– Clear Anodized Aluminum Standard –**

BLACK Black **\$460**

COLORS AND FINISHES – INSIDE BACK COVER

Flav-R-Savor® Portable Holding Cabinets

Hatco's energy efficient Flav-R-Savor® Portable Holding Cabinets will keep prepared foods at optimum serving temperatures for hours. The thermostatically-controlled heat and humidity allows food to be prepared in advance of peak serving periods.

- Allows you to hold product longer while saving you money through increased energy efficiencies
- Electronic control with digital read out, temperature range of 80°- 200°F and humidity controller
- The lower temperature range of 80°-100°F can be used for proofing all types of breads
- All stainless steel interior
- No heating element in direct contact with water makes the unit easier to clean
- Accommodates Gastronorm pans
- Electrical components, controls and digital temperature readout are located at the top for easy access
- Stacking kit available
- Doors are field convertible from left to right



FSHC-7W1-EE shown in Designer Black, with optional bumper kit, and right-hand hinged door



PORTABLE HOLDING CABINETS

Model	Description	Dimensions			Voltage	Hz	Watts	Amps	Plug	Shipping Weight	List Price
		W x D x H									
FSHC-5W1-EE	Single Door	26 ¹ / ₈ " x 31 ¹ / ₄ " x 36"			120	60	1118	9.3	NEMA 5-15P	250 lbs.	\$8383
FSHC-7W1-EE	Single Door	26 ¹ / ₈ " x 31 ¹ / ₄ " x 39"			120	60	1118	9.3	NEMA 5-15P	222 lbs.	8818
FSHC-7W2-EE	2-Door Pass-Through	26 ¹ / ₈ " x 34 ⁵ / ₈ " x 39"			120	60	1118	9.3	NEMA 5-15P	232 lbs.	9318

All Models Feature:

Interior Cabinet Capacity: 20⁷/₈"W x 26⁷/₈"D.

Top Surface Dimensions: 25³/₄"W x 28¹/₂"D.

Models Shipped with: 6" cord and plug, 4" diameter casters (with 5¹/₈" clearance), stainless steel heavy-duty door with left-hand door hinge, and adjustable rack slides (seven for the -7WX-EE units, and five for the -5W1-EE unit).

Pan Capacity: -5W1-EE: 10 full sized sheet pans or 2/1 Gastronorm pans on 1⁵/₈" spacing, 5 full sized sheet pans or 2/1 Gastronorm pans on 3¹/₄" spacing, 10 full sized hotel pans or 1/1 Gastronorm pans on 1⁵/₈" spacing.

-7Wx-EE: 14 full sized sheet pans[□] or 2/1 Gastronorm pans on 1⁵/₈" spacing, 7 full sized sheet pans or 2/1 Gastronorm pans on 2³/₄" spacing, 14 hotel sized pans or 1/1 Gastronorm pans on 1⁵/₈" spacing.

Water Tank Capacity for Humidity System: 1 gallon.

Cord Location: Recessed, back of unit, upper right side.

[□] With purchase of extra pan slides.

WATER QUALITY REQUIREMENTS – PAGE 248



FSHC-7W1-EE & FSHC-7W2-EE (120V models only) NOTE: Units equipped with a heavy-duty glass door(s) are not ENERGY STAR qualified

Holding & Display Cabinets

OPTIONS (available at time of purchase only)

Colors (Side Panels) – Non-standard colors are non-returnable – Black standard –

SS Stainless Steel **\$227**

Colors (Top) – Non-standard colors are non-returnable – Black standard –

SS Stainless Steel **\$227**

EE-GLASS Glass Door (in lieu of stainless steel door) (is not Energy Star qualified) **\$282**

EE-LPCAST Low profile casters (FSHC-5W1-EE model only) (deduct 2¹/₄" from height) **No Charge**

EE-PLATFORM Platform for mounting directly on a counter (deduct 4¹/₈" from height) (in lieu of casters) **No Charge**

EE-STACK-BLK Designer Black powdercoated stacking hardware mounted to bottom of cabinet for two FSHC-7W1 or two FSHC-5W1 units in lieu of casters (cannot have legs on lower unit) **No Charge**

EE-STACK-SS Stainless steel stacking hardware mounted to bottom of cabinet for two FSHC-7W1 or two FSHC-5W1 units in lieu of casters (cannot have legs on lower unit) **No Charge**

EE-BUMPER Bumper Hardware (only for use with standard casters) (add 1¹/₈" to height) **543**

EE-4LEGS 4" legs (in lieu of casters, deduct 1¹/₂" from height) **No Charge**

EE-6LEGS 6" legs (in lieu of casters, add 1³/₄" to height) **No Charge**

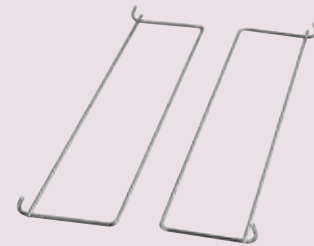

EE-1-SLIDE Accessory

ACCESSORIES (available for purchase at any time)

EE-1-SLIDE Extra Pan Slides **pair \$105**

FOOD PANS AND TRIVETS – PAGE 240

COLORS AND FINISHES – INSIDE BACK COVER





Flav-R-Savor® Low Profile, Humidified, Portable Holding Cabinets

Prepare food in advance of peak serving periods and safely hold it at optimum serving temperatures with the Flav-R-Savor® Portable Holding Cabinet. Thermostatically-controlled heat and humidity allows you to hold product for hours.

- Thermostatically-controlled heat and humidity holds hot food at optimum serving temperatures longer
- Allows preparation of food in advance of peak serving periods
- Accommodates Gastronorm pans
- Electrical components, controls, water reservoir and digital temperature readout are located at the top for easy access
- Reduced height – less than 30" high, and wider footprint for increased capacity
- Insulated side walls, field reversible glass doors, large swivel casters with wheel locks and 6" recessed cord and plug are standard
- Stacking kit available



FSHC-6W1 with accessory food pans

LOW PROFILE HOLDING CABINETS – HUMIDIFIED

Model	Description	Dimensions (W x D x H) <i>Height includes standard casters</i>	Cabinet Opening (W x H)	Top Surface Dimensions (W x D)	Plug	Ship Weight	List Price
FSHC-6W1	1 Door	25½" x 29½" x 32½"	21½" x 19"	25¾" x 25½"	NEMA 5-15P	167 lbs.	\$7090
FSHC-6W2*	2 Doors	25½" x 32" x 32½"	21½" x 19"	25¾" x 25½"	NEMA 5-15P	180 lbs.	7587

* FSHC-6W2 is a two-door pass-through single cabinet, not two units stacked.

All Low Profile Holding Cabinet Models Feature:

Voltage: 120, 60 Hz, 1697 watts, 14.1 amps. NEMA 5-15P (NEMA 5-20P Canada).

Models Shipped with: 6' cord and plug, 4" diameter casters (with 5/8" clearance), six sets of adjustable angle slides.

Pan Capacity: Six 18"W x 26"D sheet pans or six 2/1 Gastronorm pans on 3" centers, eleven 18"W x 26"D sheet pans[⌘], eleven 2/1 Gastronorm pans on 1½" centers[⌘], or twelve 20"W x 12"D x 2½"H hotel pans[⌘].

Water Tank Capacity for Humidity System: ¾ gallon.

Cord Location: Recessed, back of unit, upper right side.

[⌘]With purchase of extra pan slides.

WATER QUALITY REQUIREMENTS – PAGE 248

Holding & Display Cabinets

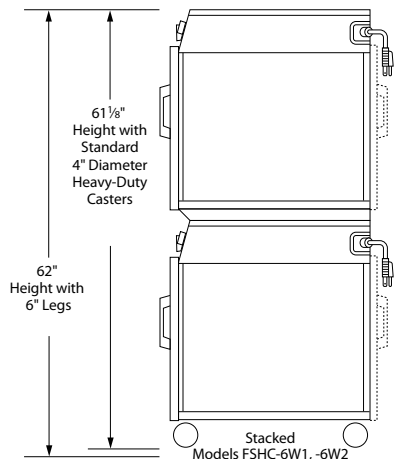
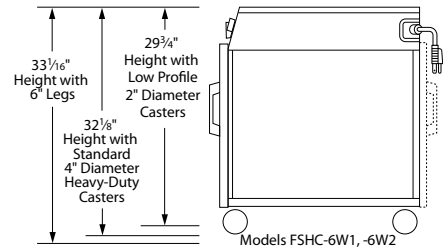
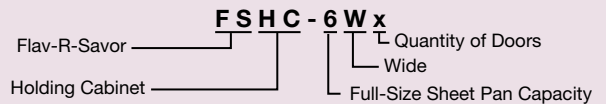

OPTIONS (available at time of purchase only)

Colors (Side Panels) – Non-standard colors are non-returnable – Silver Gray Standard –

BLACK Designer Black **\$227**

SS Stainless Steel **227**

Colors (Top) – Non-standard colors are non-returnable – Silver Gray Standard –

BLACK Designer Black **\$224**

SS Stainless Steel **224**

6W-SS-DR Stainless Steel Door in lieu of Glass Door **\$ 98**

HD-SS-DR Heavy-Duty Stainless Steel Door with Positive Latch Handle **405**

6W1-LPCAST 2" Low Profile Locking Casters in lieu of standard Casters (2" diameter with 3" clearance - Overall height is 29¾") **No Charge**

6W1-STACK Stacking Hardware mounted to top of Cabinet for two FSHC-6W1 Units in lieu of Casters (Silver Gray) **93**

CORDWIND Bracket for holding Cord during transport **37**

ACCESSORIES (available for purchase at any time)

6W1-SLIDE Extra Pan Slides **pair \$105**

FOOD PANS AND TRIVETS – PAGE 240

COLORS AND FINISHES – INSIDE BACK COVER



6W1-SLIDE Accessory

Flav-R-Savor® Humidified Portable Holding Cabinets

Prepare food in advance of peak serving periods and safely hold it at optimum serving temperatures with the Flav-R-Savor® Portable Holding Cabinet. Thermostatically-controlled heat and humidity allows you to hold product for hours.

- Thermostatically-controlled heat and humidity holds hot food at optimum serving temperatures longer
- Allows preparation of food in advance of peak serving periods
- Accommodates Gastronorm pans
- Electrical components, controls, water reservoir and digital temperature readout are located at the top for easy access
- Insulated side walls, field reversible glass doors, large swivel casters with wheel locks and 6' recessed cord and plug are standard
- Stacking kit available



FSHC-7-1 with standard 4" casters and accessory food pans

Quick-Ship Model pages 241-247

PORTABLE HOLDING CABINETS – HUMIDIFIED

Model	Description	Dimensions (W x D x H) <i>Height includes standard casters</i>	Cabinet Opening (W x H)	Top Surface Dimensions (W x D)	Plug	Ship Weight	List Price
✓ FSHC-7-1	1 Door	22 ³ / ₄ " x 29 ⁵ / ₈ " x 35 ¹ / ₈ "	18 ¹ / ₂ " x 22"	22 ⁵ / ₈ "W x 25 ⁷ / ₈ "	NEMA 5-15P	175 lbs.	\$7154
FSHC-7-2*	2 Doors	22 ³ / ₄ " x 32" x 35 ¹ / ₈ "	18 ¹ / ₂ " x 22"	22 ⁵ / ₈ "W x 25 ⁷ / ₈ "	NEMA 5-15P	180 lbs.	7656

* FSHC-7-2 is a two-door pass-through single cabinet, not two units stacked.

All Portable Cabinet Models Feature:

Voltage: 120, 60 Hz, 1697 watts, 14.1 amps, NEMA 5-15P Canada (NEMA 5-20P Canada).

Models Shipped with: 6' cord and plug, 4" diameter casters (with 5¹/₈" clearance), seven sets of adjustable angle slides for 18" x 26" pans or 12" x 20" pans.

Pan Capacity: Seven 18" x 26" sheet pans on 3" centers, seven 20" x 12" x 2¹/₂" hotel pans or seven 1/1 Gastronorm pans.

Water Tank Capacity for Humidity System: 3/4 gallon.

Cord Location: Recessed, back of unit, upper right side.

WATER QUALITY REQUIREMENTS – PAGE 248

OPTIONS (available at time of purchase only) (not available on Quick-Ship)

Colors (Side Panels) – Non-standard colors are non-returnable – Silver Gray Standard –

BLACK	Designer Black	\$227
SS	Stainless Steel	227

Colors (Top) – Non-standard colors are non-returnable – Silver Gray Standard –

BLACK	Designer Black	\$227
SS	Stainless Steel	227

SS-DR Stainless Steel Door in lieu of Glass Door **\$ 98**

HD-SS-DR Heavy-Duty Stainless Steel Door with Positive Latch Handle **405**

LWALARM Audible Low-Water Alarm **92**

LPCAST 2" Low Profile Casters in lieu of Standard Casters (2" diameter with 3" clearance - Overall Height 32³/₄") **37**

4LEGS 4" Adjustable Legs in lieu of standard Casters **No Charge**

6SS 6" Stainless Steel Legs in lieu of standard Casters **No Charge**

7-1-STACK Stacking Hardware mounted to top of cabinet for two FSHC-7-1 units in lieu of Casters (Silver Gray) **130**

CORDWIND Bracket for holding cord during transport **37**

ACCESSORIES (available for purchase at any time)

SLIDEWIRE Wire Shelf **per shelf \$137**

FOOD PANS AND TRIVETS – PAGE 240

COLORS AND FINISHES – INSIDE BACK COVER

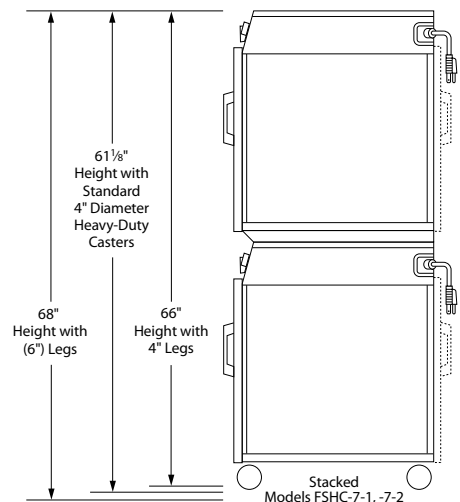
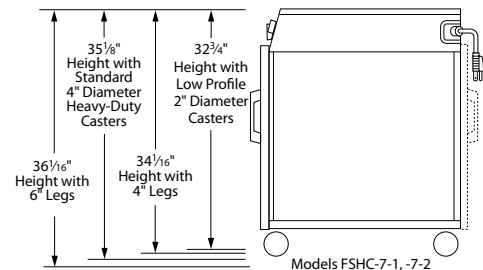
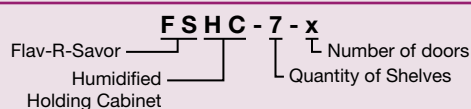



Flav-R-Savor® Tall Humidified Holding Cabinets

The expanded capacity of Hatco's Tall Humidified Cabinets offers flexibility – giving customers more variety of menu items, and holding larger quantities of proven favorites ahead of peak serving periods. The universal slides of the FSHC-17W models will hold 17 sheet pans, or 34 steam table pans. FSHC-12W models will hold 12 sheet pans and 24 steam table pans.

- Electronic controls with digital readout temperature range of 80°-200°F with precise heat and humidity settings assure uniform heating throughout the cabinet
- Using the lower temperature range of 80°-100°F allows perfect temperature for proofing all types of bread
- Lexan or stainless steel doors, full height, half height and pass-through available
- All Stainless Steel interior and exterior
- Fully insulated doors, sidewalls, base and top assist in heat retention and quick recovery
- Field reversible, right- or left-hand hinged doors with magnetic latch and heavy-duty plated hinges
- Fully welded tubular frame assures integrity of unit in any working environment



FSHC-12W1
with optional
Stainless Steel door



FSHC-17W1

Quick-Ship Model pages 241-247

Holding & Display Cabinets

TALL HUMIDIFIED HOLDING CABINETS

Model	Description	Dimensions W x D x H*	Voltage Single Phase	Watts	Amps	Plugs	Ship Weight	List Price
✓ FSHC-12W1	Single Lexan® Door	26" x 34¾" x 57¾"	120 208-240	1650 1608-2133	13.8 7.7-8.9	NEMA 5-15P NEMA 6-15P	303 lbs.	\$11390
FSHC-12W2	2 Lexan® Doors – Pass-Through	26" x 35¾" x 57¾"	120 208-240	1650 1608-2133	13.8 7.7-8.9	NEMA 5-15P NEMA 6-15P	316 lbs.	13735
✓ FSHC-17W1	Single Lexan® Door	26" x 34¾" x 73¾"	120 208-240	1650 1608-2133	13.8 7.7-8.9	NEMA 5-15P NEMA 6-15P	352 lbs.	11572
✓ FSHC-17W1D	Single Opening w/ 2 Dutch Doors	26" x 34¾" x 73¾"	120 208-240	1650 1608-2133	13.8 7.7-8.9	NEMA 5-15P NEMA 6-15P	360 lbs.	12450
FSHC-17W2	2 Lexan® Doors – Pass-Through	26" x 35¾" x 73¾"	120 208-240	1650 1608-2133	13.8 7.7-8.9	NEMA 5-15P NEMA 6-15P	365 lbs.	13834
FSHC-17W2D	4 Dutch Doors – Pass-Through	26" x 35¾" x 73¾"	120 208-240	1650 1608-2133	13.8 7.7-8.9	NEMA 5-15P NEMA 6-15P	389 lbs.	15228

* Height includes standard casters.
120V Canadian Models use NEMA 5-20P.

All Tall Humidified Holding Cabinet Models Feature:

Cabinet Opening Dimensions: **FSHC-12W:** 22"W x 43½"H.

FSHC-17W: 22"W x 59¾"H.

Models Shipped with: 10' cord and plug, 5" casters, universal slides for 18" x 26" pans or 12" x 20" pans.

Pan Capacity – **FSHC-12W:** 12-sheet pan capacity on 3" centers, adjustable on 1½" centers, with 12 universal pan slides designed to accommodate up to 12 sheet pans or up to 24 steam table pans.

Pan Capacity – **FSHC-17W:** 17-sheet pan capacity on 3" centers, adjustable on 1½" centers, with 17 universal pan slides designed to accommodate up to 17 sheet pans or up to 34 steam table pans.

Water Reservoir Capacity for Humidity System: 2 gallons.

Cord Location: Recessed, facing controls, right-hand side panel, lower right corner.

OPTIONS AND ACCESSORIES – PAGE 189
WATER QUALITY REQUIREMENTS – PAGE 248

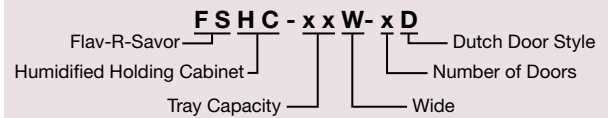



FSHC-17W1

Holding & Display Cabinets

OPTIONS (available at time of purchase only) (not available on Quick-Ship)

DELUXE	Deluxe Package (includes Flush Mount Handles and Full Perimeter Bumper)	\$ 828
TRANS	Transport Package (includes Stand-Off Handles, Full Perimeter Bumper, Heavy-duty 5" x 2" Casters (2 swivel with wheel locks and 2 rigid), and Flush Mount Transport Latch)	1462
CORDWIND	Bracket for holding cord during transport (only available with Transport Package option for -12W -17W models)	84
12W-SS-DOOR	Stainless Steel Door in lieu of Lexan® Door	No Charge
17W-SS-DOOR	Stainless Steel Door in lieu of Lexan® Door	No Charge
17WD-SS-DOOR	Stainless Steel Dutch Doors in lieu of Lexan® Dutch Doors (FSHC-17W models only)	No Charge

ACCESSORIES (available for purchase at any time)

17W-SLIDE	Extra Pan Slides (FSHC-12W and FSHC-17W)	pair \$150
------------------	--	-------------------

FOOD PANS AND TRIVETS – PAGE 240



Flav-R-Savor® Heated Air Curtain Cabinets

The patented Flav-R-Savor® Heated Air Curtain Cabinet effectively and safely holds hot food hot without the use of doors, allowing immediate access to product. Warm air at the front of the cabinet is forced downward, through the ducts above the opening, forming a “curtain” of heated air. A portion of the heated air is drawn toward the rear of the cabinet, warming each pan.



FS2HAC-15 with 1/3 size food pans (pans not included)

- Perfect for holding wrapped or sealed product like tortillas, burritos and ribs, as well as product on sheet pans like biscuits, hamburger patties and baked potatoes or fried foods in pans
- Available in 2-pan and 3-pan models, single opening or pass-through, with or without humidity
- The FS2HAC-15 holds 6, 1/3 size pans (pans not included)
- The 2-pan pass-through accommodates two full-size sheet pans or four half-size sheet pans, and the 4-pan unit accommodates four full-size sheet pans or eight half-size sheet pans
- FS2HAC-15 comes standard with a pan rack, removeable crumb tray, USB port and a touch screen control with temperature and timer display, and a 6' cord and plug



FSHACH-2 with accessory food pans



FS2HAC-2PT with accessory food pans

Holding & Display Cabinets

HEATED AIR CURTAIN CABINETS

Model	Description	Dimensions (W x D x H)	Cabinet Opening Dimensions (W x H)	Voltage	Watts	Amps	Plugs	Ship Weight	List Price
FSHAC-2*	2-Tier Warmer	20 ⁷ / ₈ " x 22 ⁷ / ₈ " x 18 ¹ / ₈ "	18 ¹ / ₄ " x 9 ¹ / ₈ "	120	1850	15.4	NEMA 5-20P	102 lbs.	\$5749
FSHAC-2*	2-Tier Warmer	20 ⁷ / ₈ " x 22 ⁷ / ₈ " x 18 ¹ / ₈ "	18 ¹ / ₄ " x 9 ¹ / ₈ "	120/208	1877	9.0	NEMA L14-20P	102 lbs.	5749
FSHAC-3*	3-Tier Warmer	20 ⁷ / ₈ " x 22 ⁷ / ₈ " x 30 ¹ / ₂ "	18 ¹ / ₄ " x 18 ¹ / ₈ "	120/208	1877	9.0	NEMA L14-20P	105 lbs.	6003
FS2HAC-15	Open Cavity Warmer	15 ¹ / ₂ " x 21 ¹ / ₄ " x 21 ³ / ₄ "	14 ³ / ₄ " x 13"	120	1105	9.2	NEMA 5-15P*	83 lbs.	5358
FS2HAC-2PT*	2-Tier Pass-Through	24 ¹ / ₈ " x 39 ¹ / ₈ " x 18 ¹ / ₂ "	18 ¹ / ₁₆ " x 8 ¹ / ₈ "	120/208 or 120/240	2589	10.8	NEMA L14-20P	175 lbs.	8752
FS2HAC-4PT*	4-Tier Pass-Through	24 ¹ / ₈ " x 39 ¹ / ₈ " x 26 ¹ / ₂ "	18 ¹ / ₄ " x 16 ¹ / ₂ "	120/208 or 120/240	3389	14.2	NEMA L14-20P	211 lbs.	9561

* Height includes 4" legs.

^ Canadian models use NEMA 6-15P.

All Standard Models Feature:

Cord Location: FSHAC-2, -3: Top of unit towards the back, middle.

FS2HAC-15: Top of unit towards the back, right side.

FS2HAC-2PT, -4PT: Top of unit towards the back, left side.

HEATED AIR CURTAIN CABINETS – HUMIDIFIED

Model	Description	Dimensions (W x D x H)	Cabinet Opening Dimensions (W x H)	Voltage	Watts	Amps	Plugs	Ship Weight	List Price
FSHACH-2	2-Tier Warmer	20 ⁷ / ₈ " x 24 ³ / ₈ " x 18 ¹ / ₈ "	18 ¹ / ₄ " x 9 ¹ / ₈ "	120/208	2950	14.2	NEMA L14-20P	100 lbs.	\$6714
FSHACH-3*	3-Tier Warmer	20 ⁷ / ₈ " x 24 ³ / ₈ " x 30 ¹ / ₂ "	18 ¹ / ₄ " x 18 ¹ / ₈ "	120/208	2950	14.2	NEMA L14-20P	100 lbs.	7016
FSHACH-2PT*	2-Tier Pass-Through	24 ¹ / ₈ " x 35 ⁵ / ₈ " x 22"	18 ¹ / ₄ " x 9 ¹ / ₄ "	120/208	4952	23.8	NEMA L14-30P	150 lbs.	9654
FSHACH-2PT*	2-Tier Pass-Through	24 ¹ / ₈ " x 35 ⁵ / ₈ " x 22"	18 ¹ / ₄ " x 9 ¹ / ₄ "	208	4952	23.8	NEMA L6-30P	150 lbs.	9654

* Height includes 4" legs.

All Heated Air Curtain Cabinet Models Feature:

Models Shipped with: Auto-fill water reservoir and water filter. 4" legs also come standard (excluding FSHACH-2)

Water Tank Capacity for Humidity System: FSHACH-2, -3: 2¹/₄ gallons.

FSHACH-2PT: 3 gallons.

Cord Location: FSHACH-2, -3: Top of unit towards the back, middle.

FSHACH-2PT: Top of unit towards the back, left side.

FOOD PANS AND TRIVETS – PAGE 240

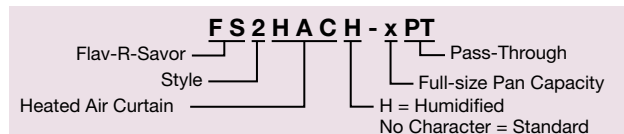
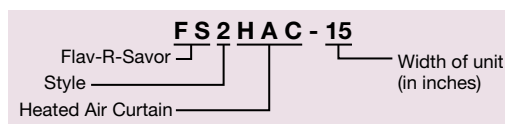

Toasters

*Cafeterias • Buffets • Supermarkets & Delis
Restaurants & Cafés • Clubs & Bars • Catering*



ITQ-1750-2C *pg. 192*



TPT-120 *pg. 193*



TQ3-400 *pg. 194*



TQ-400 *pg. 195*



TQ-1800 *pg. 195*



TK-100 *pg. 197*



Intelligent Toast-Qwik®

Hatco's Intelligent Toast-Qwik® allows the operator to toast multiple products at the touch of the button, changing easily from bagels to croissants to Texas toast to hash browns, as well as melting cheese and finishing smaller food products. The unit can easily take the place of the current toasting platform and add versatility and future menu expansion, along with energy efficiency and cost savings.

- The conveyor toaster can operate in four different modes:
 - ~ Continuous Through Put
 - ~ Select Single Item Mode
 - ~ In and Reverses Out Mode
 - ~ In, Pause, then Continues Through
- USB port located on the front allows for easy transfer of information, such as program changes and product usage information
- The ability to program up to twenty product settings

- Hatco's patented ColorGuard Sensing System monitors and adjusts conveyor speed and temperature during high usage periods to ensure toast color uniformity
- Using Hatco's Spot-On® Technology, the toaster senses when product is placed on the conveyor and activates the unit
- Easy to clean, with removable crumb tray and collector ramp. There is minimal operator maintenance required, with self-cleaning elements and no maintenance motor and conveyor drives



ITQ-875-1C



ITQ-1000-1C



ITQ-1750-2C

HORIZONTAL CONVEYOR TOASTERS

Model	Voltage	Dimensions W x D x H	Watts	Amps	Capacity/ Minute†	Plug	Ship Weight	List Price
ITQ-875-1C	208	14 $\frac{5}{8}$ " x 28 $\frac{3}{4}$ " x 16 $\frac{5}{8}$ "	2700	13.0	15	NEMA 6-20P	86 lbs.	\$6485
ITQ-875-1C	240	14 $\frac{5}{8}$ " x 28 $\frac{3}{4}$ " x 16 $\frac{5}{8}$ "	2700	11.3	15	NEMA 6-20P	86 lbs.	6485
ITQ-1000-1C®	208-240	17 $\frac{5}{8}$ " x 28 $\frac{5}{8}$ " x 18"	3230-4300	15.5-17.9	17	NEMA 6-30P	89 lbs.	6625
ITQ-1750-2C	208	20 $\frac{1}{4}$ " x 28 $\frac{3}{4}$ " x 18 $\frac{1}{2}$ "	4960	23.8	30	NEMA 6-30P	106 lbs.	8833
ITQ-1750-2C	240	20 $\frac{1}{4}$ " x 28 $\frac{3}{4}$ " x 18 $\frac{1}{2}$ "	4960	20.7	30	NEMA 6-30P	106 lbs.	8833

† Toasting capacity may vary by product. Toasting of coated products not recommended.

® Unit is designed to operate on supply voltages between 208V and 240V.

All Horizontal Conveyor Toaster Models Feature:

Opening Dimensions: ITQ-875-1C: 5 $\frac{5}{8}$ "W x 2 $\frac{1}{8}$ "H.

ITQ-1000-1C: 9 $\frac{3}{8}$ "W x 2"H.

ITQ-1750-2C: Two openings at 5 $\frac{5}{8}$ "W x 2 $\frac{1}{4}$ "H.

Cord Location: 6' cord – left center on back of unit.

OPTIONS (available at time of purchase only)

ITQ-L6-20	NEMA L6-20P Locking Cap in lieu of NEMA 6-20P	\$194
ITQ-L6-30	NEMA L6-30P Locking Cap in lieu of NEMA 6-30P	43

ACCESSORIES (available for purchase at any time)

Paddle, with high temp, non-stick coating –		
ITQ1C-PAD	9" wide Food Paddle for ITQ-1000-1C model only	\$200
ITQ2C-PAD	5.7" wide Food Paddle for ITQ-875-1C and ITQ-1750-2C models only	153
ITQ2CFEED175	Feed Ramp for ITQ-1750-2C only (sold as single ramp only)	93



ITQ2C-PAD
Accessory

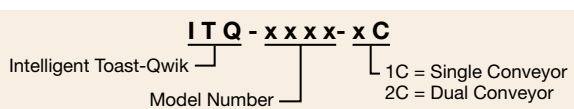

POP-UP Toasters

Perfect for self-serve areas and light volume applications, the Hatco Pop-Up Toasters provide even golden toasting of a variety of bread products. The durable stainless steel housing contains four extra wide self-centering slots with individual toasting controls and removable crumb tray.

- Evenly toasts a variety of bread products including bagels, Texas toast, waffles and English muffins
- All models have four self-centering 1 1/4" wide slots
- A selector switch for single- or double-sided toasting (excluding TPT-120)
- Durable stainless steel construction
- Individual toasting controls
- Removable crumb trays for easy cleaning
- 6' cord with plug



TPT-120



TPT-208 Selector switch for single- or double-sided toasting (excluding TPT-120)

Quick-Ship Model pages 241-247

POP-UP TOASTERS

Model	Dimensions W x D x H	Voltage	kW	Plug	Ship Weight	List Price
✓ TPT-120*	13 5/8" x 12 3/8" x 8 1/8"	120	1.8	NEMA 5-15P	14 lbs.	\$496
✓ TPT-208*	13 3/8" x 12 3/8" x 8 1/8"	208	2.6	NEMA 6-15P	16 lbs.	895
✓ TPT-240	13 3/8" x 12 3/8" x 8 1/8"	240	2.6	NEMA 6-15P	16 lbs.	895

* Canadian model is 1.4 kW.
* Canadian model uses NEMA 6-20P.

All Pop-Up Models Feature:

Slot Opening: 1 1/4"W x 5 1/2"D.

Cord Location: 6' cord – back of unit, lower center.

Pop-Up Toasters can be shipped Fed-Ex Ground or United Parcel Service.

TPT TOASTER AMP RATINGS

Model	120V/1 Ø Amps	208V/1 Ø Amps	240V/1 Ø Amps
TPT-120	15.0	–	–
TPT-120*	12.0	–	–
TPT-208	–	12.5	–
TPT-240	–	–	10.9

* Canada only

OPTIONS (available at time of purchase only)

Designer Color – Non-standard colors are non-returnable – Stainless Steel Standard –		
BBLACK	Bold Black (TPT-120 only)	\$127
RRED	Radiant Red (TPT-120 only)	127

COLORS AND FINISHES – INSIDE BACK COVER



TPT - x x x

Toaster Pop-Up Type | Voltage

Toast-Qwik® Conveyor Toasters

Hatco's industry-leading Toast-Qwik® Toasters have been completely redesigned to provide a great new look, easy to use touchscreen controller (excluding TQ3-10) and increased production capabilities. They continue to provide the best reliability, flexibility and value of any conveyor toaster available!

- Patented ColorGuard Sensing System which monitors chamber temperature and adjusts conveyor speed to ensure consistent toast results - even in your busiest periods
- The TQ-10 features an Air Intake Filter screen on the front of the unit, while the rest of the line features a removable bottom screen. Both versions removable for easy cleaning
- Up to 12 programmable settings for precise and instant product changes (excludes TQ3-10)
- USB port for software updates (excludes TQ3-10)
- Crumb tray is removable for easy cleaning
- 2" high opening standard - 3" high opening available on the TQ-500H, -900H and -2000H models for thicker bread products



TQ3-2000
in standard
Designer Black



TQ3-500 in optional
Designer Warm Red



TQ3-10
available in
Designer Black only

Quick-Ship Model pages 241-247

HORIZONTAL CONVEYOR TOASTERS

Model	Opening Dimensions (W x H)	Dimensions (W x D x H) <i>Height includes legs</i>	Voltage 50/60Hz	Watts	Amps	Plug	Ship Weight	List Price
✓ TQ3-10 [▲]	10 ³ / ₈ " x 2"	14 ¹ / ₂ " x 21 ³ / ₁₆ " x 16 ³ / ₁₆ "	120	1780	14.8	NEMA 5-15P	54 lbs.	\$1458
✓ TQ3-10	10 ³ / ₈ " x 2"	14 ¹ / ₂ " x 21 ³ / ₁₆ " x 16 ³ / ₁₆ "	208 or 240	1780	8.6 or 7.4	NEMA 6-15P	54 lbs.	1458

HORIZONTAL CONVEYOR TOASTERS

Model	Opening Dimensions (W x H)	Dimensions (W x D x H) <i>Height includes legs</i>	Voltage 50/60Hz	Watts	Amps	Plug	Ship Weight	List Price
✓ TQ3-400 ^{▲▲}	10 ³ / ₈ " x 2"	14 ³ / ₄ " x 20 ⁵ / ₈ " x 17 ¹ / ₈ "	120	1780	14.8	NEMA 5-15P	48 lbs.	\$2802
✓ TQ3-500	10 ³ / ₈ " x 2"	14 ³ / ₄ " x 20 ⁵ / ₈ " x 17 ¹ / ₈ "	208 or 240	2220	10.7 or 9.3	NEMA 6-15P	54 lbs.	2986
✓ TQ3-500H	10 ³ / ₈ " x 3"	14 ³ / ₄ " x 20 ⁵ / ₈ " x 17 ¹ / ₈ "	208 or 240	2220	10.7 or 9.3	NEMA 6-15P	54 lbs.	2986
✓ TQ3-900	10 ³ / ₈ " x 2"	14 ³ / ₄ " x 20 ⁵ / ₈ " x 17 ¹ / ₈ "	208 or 240	3020	14.5 or 12.6	NEMA 6-20P	50 lbs.	3190
✓ TQ3-900H	10 ³ / ₈ " x 3"	14 ³ / ₄ " x 20 ⁵ / ₈ " x 17 ¹ / ₈ "	208 or 240	3020	14.5 or 12.6	NEMA 6-20P	55 lbs.	3190
Toasts Three Slices Wide								
✓ TQ3-2000	14 ¹ / ₈ " x 2"	18 ³ / ₄ " x 23 ⁵ / ₈ " x 17 ¹ / ₈ "	208 or 240	4020	19.3 or 16.8	NEMA 6-30P	67 lbs.	\$4019
✓ TQ3-2000H	14 ¹ / ₈ " x 3"	18 ³ / ₄ " x 22 ³ / ₄ " x 17 ¹ / ₈ "	208 or 240	4020	19.3 or 16.8	NEMA 6-30P	67 lbs.	4019

▲ Canadian model uses NEMA 5-20P.

• TQ3-400 ships with a loose aluminum toast tray.

All Toast-Qwik® Models Feature:

Cord Location: 6' cord – back of unit, lower right corner.

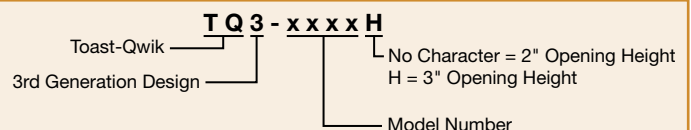

OPTIONS (available at time of purchase only)

Designer Colors – Non-standard colors are non-returnable – Designer Black Standard –

SS	Stainless Steel (excluding TQ3-10)	\$249
WRED	Designer Warm Red (excluding TQ3-10)	No Charge
TQ3-30CORD	NEMA 6-30P cord (in lieu of standard cord on TQ3-500 and -900 series only)	\$ 93
SSINSERT	Stainless Steel toast tray insert (on TQ3-500 and -900 series only)	48
TQ3-RAMP	Extended feed ramp in lieu of existing ramp - adds 3" (excludes TQ3-10 and -400 models)	128
TQ3-RAMP-XL	XL extended feed ramp in lieu of existing ramp - adds 9" (on TQ3-500 and -900 models only)	48

COLORS AND FINISHES – INSIDE BACK COVER

Toast-Qwik® Conveyor Toasters

Flexibility and performance are yours with the Hatco Toast-Qwik® conveyor toasters. These toasters produce perfect golden toasting, from 300 to 1800 slices per hour. The power save mode conserves energy during non-peak serving times.

- Instant and precise adjustment of toast color with electronic infinite controls that regulate top and bottom heat
- Patented ColorGuard sensing system assures toast uniformity
- Opening height for H and HBA models is 3", for all other models the opening height is 2"
- Insulation and an interior fan provide cool surface temperatures
- Efficient design of front or rear discharge allows unit to be placed where it is most convenient – for sending product to the operator side or to the customer/server side
- TQ-1800 Series are 3-slice wide
- BA models toast one side only and are for bagels and buns, cut side up



TQ-10



TQ-800HBA

HORIZONTAL CONVEYOR TOASTERS

Model	Dimensions (W x D x H) Height includes legs	Opening Dimensions (W x H)	Voltage/60Hz	kW	Plug	Capacity/Minute [†]	Ship Weight	List Price
TQ-10 [▲]	14½" x 17¾" x 13¾"	10¾" x 2"	120	1.8	NEMA 5-15P	5 slices	42 lbs.	\$1841
TQ-10	14½" x 17¾" x 13¾"	10¾" x 2"	208, 240	1.8	NEMA 6-15P	5 slices	42 lbs.	1841

HORIZONTAL CONVEYOR TOASTERS

Model	Dimensions W x D x H*	Opening Dimensions (W x H)	Voltage/60Hz	kW	Plug	Capacity/Minute [†]	Ship Weight	List Price
TQ-400 [▲]	14½" x 17¾" x 14⅞"	10¼" x 2"	120	1.8	NEMA 5-15P	6 slices	46 lbs.	\$2874
TQ-400	14½" x 17¾" x 14⅞"	10¼" x 2"	208, 240	2.2	NEMA 6-15P	6 slices	46 lbs.	2874
TQ-400BA ^{▲▼}	14½" x 17¾" x 14⅞"	10¼" x 2"	120	1.8	NEMA 5-15P	6 slices	46 lbs.	2874
TQ-400BA [▼]	14½" x 17¾" x 14⅞"	10¼" x 2"	208, 240	1.9	NEMA 6-15P	6 slices	46 lbs.	2874
TQ-400H	14½" x 17¾" x 15⅞"	10¼" x 3"	208, 240	2.2	NEMA 6-15P	6 slices	46 lbs.	2874
TQ-800	14½" x 22¾" x 16⅞"	10⅝" x 2"	208	3.3	NEMA 6-20P	14 slices	64 lbs.	3277
TQ-800 [♦]	14½" x 22¾" x 16⅞"	10⅝" x 2"	240	3.3	NEMA 6-15P	14 slices	64 lbs.	3277
TQ-800BA [▼]	14½" x 22¾" x 16⅞"	10⅝" x 2"	208	3.3	NEMA 6-20P	14 slices	62 lbs.	3277
TQ-800BA ^{▼♦}	14½" x 22¾" x 16⅞"	10⅝" x 2"	240	3.3	NEMA 6-15P	14 slices	62 lbs.	3277
TQ-800H	14½" x 22¾" x 16⅞"	10⅝" x 3"	208	3.3	NEMA 6-20P	14 slices	62 lbs.	3277
TQ-800H [♦]	14½" x 22¾" x 16⅞"	10⅝" x 3"	240	3.3	NEMA 6-15P	14 slices	62 lbs.	3277
TQ-800HBA [▼]	14½" x 22¾" x 16⅞"	10⅝" x 3"	208	3.3	NEMA 6-20P	13 slices	65 lbs.	3277
TQ-800HBA ^{▼♦}	14½" x 22¾" x 16⅞"	10⅝" x 3"	240	3.3	NEMA 6-15P	13 slices	65 lbs.	3277

Toasts Three Slices Wide

TQ-1800	18½" x 22¾" x 16⅞"	14⅜" x 2"	208, 240	4.4	NEMA 6-30P	30 slices	73 lbs.	\$4080
TQ-1800BA [▼]	18½" x 22¾" x 16⅞"	14⅜" x 2"	208, 240	4.6	NEMA 6-30P	30 slices	75 lbs.	4080
TQ-1800H	18½" x 22¾" x 16⅞"	14⅜" x 3"	208, 240	4.7	NEMA 6-30P	30 slices	76 lbs.	4080
TQ-1800HBA [▼]	18½" x 22¾" x 16⅞"	14⅜" x 3"	208, 240	4.6	NEMA 6-30P	30 slices	74 lbs.	4080

[†] Toasting capacity may vary by product. Toasting of coated products not recommended.

• Height includes legs. TQ-400 and TQ-400BA, add 2½" to depth if using tray extension in rear. TQ-800, TQ-800BA, TQ-800H, TQ-800HBA, TQ-1800, TQ-1800BA, TQ-1800H and TQ-1800HBA, add 6½" to depth if using tray extension in rear.

▲ Canadian model uses NEMA 5-20P.

▼ BA models toast one side only and are for bagels and buns, cut side up.

♦ Canadian model uses NEMA 6-20P.

All Conveyor Toaster Models Feature:

Cord Location: 6' cord – back of unit, lower right corner.

Toast-Qwik Toasters can be shipped Fed-Ex Ground or United Parcel Service.

OPTIONS AND ACCESSORIES – PAGE 196

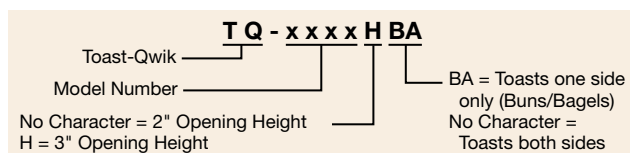



TQ-800H Toast Qwik®
Horizontal Conveyor Toaster

OPTIONS (available at time of purchase only, excludes TQ-10) (not available on Quick-Ship)

TQ-PWR-A	Automatic Power Save Mode (switches to Power Save Mode after 30 minutes of inactivity)	No Charge
-----------------	---	------------------

ACCESSORIES (available for purchase at any time)

TQRAMP	Additional Extended Feed Guide adds 3" (Not available on TQ-1800 Series)	\$130
TQ2-SECURITY	Control Cover and Bracket (not available on TQ-1800 series)	120



TQ-800 with
TQ2-SECURITY
accessory security
control cover

Toasters

TQ TOASTER AMP RATINGS

Model	120V/1 Ø	208V/1 Ø	240V/1 Ø
TQ-10	15.0	8.8	7.6
TQ-400	14.9	10.7	9.3
TQ-400BA	14.8	9.0	7.8
TQ-400H		10.3	9.3
TQ-800		16.0	13.9
TQ-800BA		15.8	13.7
TQ-800H		16.0	13.9
TQ-800HBA		15.8	13.7
TQ-1800		21.4	18.5
TQ-1800H		22.4	19.4
TQ-1800BA		22.0	19.1
TQ-1800HBA		22.0	19.1

Toast King® Conveyor Toasters

Designed for mid- to high-volume and constant flow applications, Hatco's proven reliability and performance makes the Toast King® Toasters the workhorse of your operation. These toasters use conveyor speed, not temperature, to determine toast color.

- Toasts a variety of bread products
- Stainless steel construction for years of trouble-free service
- Power-saving thermostat for energy savings during non-peak times
- Manual advance, speed control and cord with plug included
- Fully insulated for cooler operation
- Multiple metal sheathed toasting elements
- Toast storage area keeps bread warm and dry
- Capacity of 720-1500 slices per hour
- Three basket access for fast loading
- Top venting keeps heat away from the operator



TK-135B



TK-72

Quick-Ship Model pages 241-247

VERTICAL CONVEYOR TOASTERS

Model	Description	Dimensions* W x D x H	Basket Size W x H	Voltage Single Phase	Hz	Capacity/ Minute†	Plug	Ship Weight	List Price
✓ TK-72"	Bread and Buns	18¼" x 17⅞" x 33¼"	10" x 4⅝"	208 or 240	60	12 slices	NEMA 6-20P	73 lbs.	\$5014
✓ TK-100	Bread and Buns	22¾" x 17⅞" x 33¼"	14½" x 4⅝"	208 or 240	60	16 slices	NEMA 6-30P	88 lbs.	5364
TK-135B*	Buns Only	22¾" x 17⅞" x 33¼"	14½" x 4⅝"	208 or 240	60	22 slices	NEMA 6-30P	88 lbs.	5366
TK-155B	3-Part Buns	22¾" x 17⅞" x 33¼"	14½" x 4⅝"	208 or 240	60	25 slices	NEMA 6-30P	88 lbs.	5657

*Width included ¾" for manual advance knob. Depth includes tray extension of 3½".
 † Toasting capacity may vary by product. Toasting of coated products not recommended.
 ‡ Canadian model uses NEMA 6-30P.
 † 240V model uses NEMA 6-20P (Canadian model uses NEMA 6-30).

All Vertical Conveyor Models Feature:

Max. Product Thickness: 1¼".
 Cord Location: 4' cord – back of unit, lower left side.

Toasters

OPTIONS (available at time of purchase only) (not available on Quick-Ship)

TK-SECURITY Control Cover, Bracket, Mounting Hardware and Fuse Cover **\$232**

ACCESSORIES (available for purchase at any time)

4" LEGS 4" Adjustable Legs (4) **\$60**

TK TOASTER AMP RATINGS

Model	208V/1 Ø		kW
	Amps	Amps	
TK-72	19.4	16.8	4.0
TK-100	24.0	21.0	5.0
TK-135B	20.9	18.1	4.3
TK-155B	24.1	20.9	5.0

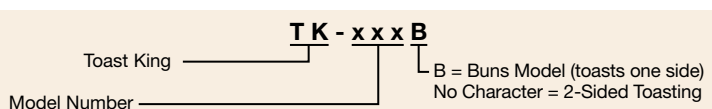

Induction Equipment

Cafeterias • Buffets
Supermarkets & Delis • Restaurants & Cafés
Clubs & Bars



IRNG-BXC1-14 pg. 199



IRNG-HC1-18 pg. 200



IRNG-PC1-18 pg. 201



IRNG-PB1-18 pg. 202



IRNG-PC1-36 pg. 203



IWRM-CD1-03 pg. 207



IWRM-B1-1313-06 in white glass-ceramic top
pg. 208



IWRM-UT-06 pg. 209

Boxer® Countertop Induction Ranges

Hatco's Boxer® Induction Range has all the same power as our Hatco line of induction ranges, but with no frills. This economy model is simple to operate and has the Magnetic Power System (MPS), delivering the highest power in its class!

This unit has all the basics for the rigors of commercial foodservice use, as well as a timer with convenient power and temperature modes.

- Heavy gauge stainless steel housing with side impact protection for the top
- Large control knob is adaptive and adjusts to user input. From precise, fine control (slow turns) to spanning the full range in a single twist (fast turns)
- Display instantly advises the operator of precise power, temperature (°F or °C) and time control (30 seconds to 1 hour)
- Black, glass-ceramic top is durable and easy to clean – fully sealed top and conformal-coated boards add extra protection against grease or moisture
- Suitable for front of the house use with an ultra-quiet cooling fan
- Safety and convenience features, such as automatic shut-off, to prevent overheating

IRNG-BXC1-14



Close up of patterned black glass-ceramic top – helps prevent noticeable scratches due to heavy use



Quick-Ship Model pages 241-247

COUNTERTOP INDUCTION RANGES

Model	Item No.	Dimensions W x D x H	Voltage Single Phase	Watts	Ship Weight†	List Price
✓ IRNG-BXC1-14	IRNGBXC114515	12 ⁷ / ₈ " x 17 ⁵ / ₈ " x 4"	120	1440	17 lbs.	\$1232
✓ IRNG-BXC1-18§	IRNGBXC118515	12 ⁷ / ₈ " x 17 ⁵ / ₈ " x 4"	120	1800	18 lbs.	1232

† Shipping weights are approximate.

§ Not available for Canada.

All Countertop Models Feature:

Models Shipped with: A 71" cord and plug.

Cord Location: Rear right bottom base corner.

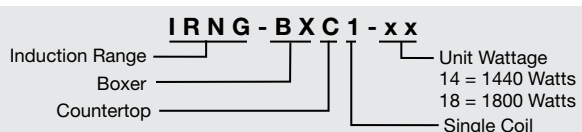



Rapide Cuisine® Countertop Heavy-Duty Induction Ranges

Hatco's Rapide Cuisine® Heavy-Duty Induction Range is designed for intense commercial foodservice applications. This model is simple to operate and has the Magnetic Power System (MPS), delivering the highest power in its class!

The unit features a large control knob, extra side impact protection and a scratch-hiding cooktop surface.

- Large control knob is adaptive and adjusts to user input. From precise, fine control (slow turns) to spanning the full range in a single twist (fast turns)
- Patterned, glass-ceramic top that is durable, easy to clean and helps scratches from heavy use appear less noticeable
- Includes a grease filter and extra side impact protection
- High resolution TFT (thin film transistor) display instantly advises the operator of precise power (1 to 100) and time control (30 seconds to 10 hrs.)
- Fully-sealed top with conformal coated boards adds extra protection against grease or moisture
- Keeps its "cool" even in hot kitchen environments
- Pan Sense Technology (PST) activates the unit only when a suitable pan is placed on top
- Safety and convenience features such as automatic shut-off to prevent overheating
- Low-profile, contemporary design and low noise cooling fan
- USB port for downloading updates

Close up of patterned black glass-ceramic top – helps prevent noticeable scratches due to heavy use



IRNG-HC1-14

Quick-Ship Model pages 241-247

COUNTERTOP HEAVY-DUTY INDUCTION RANGES

Model	Item No.	Dimensions W x D x H	Voltage Single Phase	Watts	Ship Weight [†]	List Price
✓ IRNG-HC1-14	IRNGHC114SB515	13" x 17" x 3 3/8"	120	1440	17 lbs.	\$1552
✓ IRNG-HC1-18[§]	IRNGHC118SB515	13" x 17" x 3 3/8"	120	1800	17 lbs.	1552

[†]Shipping weights are approximate.

[§] Not available for Canada.

All Countertop Heavy-Duty Models Feature:

Models Shipped with: A 71" cord and plug.

Cord Location: Rear left bottom base corner.

Induction Equipment

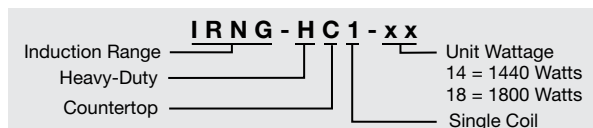

Rapide Cuisine® Countertop Induction Ranges

Hatco's Rapide Cuisine® Professional Induction Range is designed and built for the rigors of commercial foodservice use. Its Magnetic Power System (MPS) delivers the highest power in its class!

It has brains and beauty with a sleek, modern, low-profile design, high resolution color display, timer, plus convenient power and temperature modes. All this and energy efficient too!

- Programmable mode where the operator can create preset programs for consistent cooking cycles
- High resolution TFT (thin film transistor) displays instantly advises the operator of precise power (1 to 100), temperature (°F or °C in one degree increments) and time control (30 seconds to 10 hours)



- Tough enough for back-of-the-house cooking and prep areas but is still easily portable and adaptable for buffets and many other front-of-the-house applications

- Easy to use color-coded selectable functions
- Adaptive control knob adjusts to user input. From precise, fine control (slow turns) to spanning the full range in a single twist (fast turns)
- Elegant, contemporary, low-profile, design with a choice of color combinations to match your décor



Includes a food temperature probe which facilitates highly accurate cooking

IRNG-PC1-14
shown in the standard finishes

- Pan Sense Technology (PST) activates the unit only when a suitable pan is placed on top
- Black glass-ceramic top is durable and easy to clean – fully-sealed top and conformal coated boards adds extra protection against grease or moisture
- Automatic shut-off to prevent overheating
- Withstands high ambient kitchen temperatures up to 124°F
- USB port for downloading updates

Quick-Ship Model pages 241-247

COUNTERTOP INDUCTION RANGES

Model	Item No.	Dimensions W x D x H	Top Housing	Bottom Housing	Voltage Single Phase	Watts	Shipping Weight [†]	List Price
✓ IRNG-PC1-14	IRNGPC114SB515	13" x 17" x 3 3/8"	Stainless Steel (Standard)	Bold Black (Standard)	120	1440	17 lbs.	\$1426
✓ IRNG-PC1-18[§]	IRNGPC118SB515	13" x 17" x 3 3/8"	Stainless Steel (Standard)	Bold Black (Standard)	120	1800	17 lbs.	1426
✓ IRNG-PC1-18[§]	IRNGPC118BB515	13" x 17" x 3 3/8"	Bold Black	Bold Black	120	1800	17 lbs.	1550

[†] Shipping weights are approximate.

[§] Not available for Canada.

All Countertop Models Feature:

Models Shipped with: A 71" cord and plug and a food temperature probe.

Cord Location: Rear left bottom base corner.



IRNG-PC1-18
shown in the Bold Black top and bottom housing

COLORS AND FINISHES – INSIDE BACK COVER

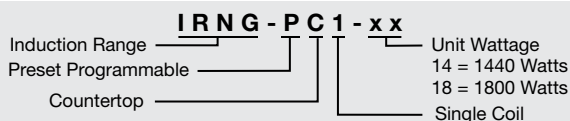



Rapide Cuisine® Drop-In Induction Ranges

Hatco's Rapide Cuisine® Drop-In Professional Induction Range is designed and built for the rigors of commercial foodservice use. Its Magnetic Power System (MPS) delivers the highest power in its class!

This unit can be mounted flush or near flush with the optional trim ring. It has brains and beauty with a high resolution color display, timer, plus convenient power and temperature modes.

- Programmable mode where the operator can create preset programs for consistent cooking cycles and quality product
- High resolution TFT (thin film transistor) display instantly advises the operator of precise power (1 to 100), temperature (°F or °C in one degree increments) and time control (30 seconds to 10 hours)



- Easy to use, color-coded selectable functions

- Adaptive control knob adjusts to user input. From precise, fine control (slow turns) to spanning the full range in a single twist (fast turns)
- Pan Sense Technology (PST) activates the unit only when a suitable pan is placed on top
- Black glass-ceramic top is both durable and easy to clean
- Fully-sealed top with conformal coated boards add extra protection against grease or moisture
- Safety and convenience features such as automatic shut-off to safely prevent overheating
- USB port for downloading updates



Includes a food temperature probe which facilitates highly accurate cooking

Quick-Ship Model pages 241-247

DROP-IN INDUCTION RANGES

Model	Item No.	Dimensions W x D x H	Voltage Single Phase	Watts	Ship Weight [†]	List Price
✓ IRNG-PB1-14	IRNGPB114515	13½" x 14½" x 3½"	120	1440	17 lbs.	\$1552
✓ IRNG-PB1-18 [▲]	IRNGPB118515	13½" x 14½" x 3½"	120	1800	17 lbs.	1552

[†] Shipping weights are approximate.
[▲] Canadian model (Item No. IRNGPB118520).

All Drop-In Models Feature:

Control Panel: 12"W x 4½"H.

Models Shipped with: A 51" cable from the base unit to the control panel, a 71" cord and plug, and a food temperature probe.

Cord Location: Rear left bottom base corner.

ACCESSORY (available at any time)

Holds unit nearly flush on the counter (for use where chair-step routing of a countertop material is not possible (stainless steel or any similar material), but a flush mount look is desired) –

Trim Ring in Stainless Steel for **IRNG-PB1-14** or **-18** (holds unit nearly flush

TRIM-PB1-18 on a stainless steel or any similar material countertop) **\$63**

Induction Equipment

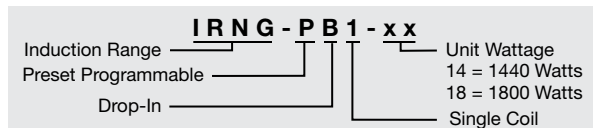

Rapide Cuisine® Countertop High-Powered/Heavy-Duty Induction Ranges

Hatco's Rapide Cuisine® High-Powered/Heavy-Duty Induction Ranges offer industry leading features and true back-of-house power in a commercial kitchen-proof package.

The unit features our Magnetic Power System (MPS) to deliver the highest power in its class! It has User Programmable Presets (UPP) for repeat menu items and a food temperature probe for more accurate cooking, plus a timer, high resolution color display and convenient power and temperature modes.

- Commercial kitchen ready. Heavy gauge stainless steel housing with side impact protection for the top
- Four surface temperature sensors offer the most accurate control in its class
- Culinary equivalent of up to 31,000 BTUs gas
- High resolution TFT (thin film transistor) display instantly advises the operator of precise power (1 to 100), temperature (°F in one degree increments) and time control (30 seconds to 10 hours)
- Programmable mode so the operator can create preset programs for consistent cooking cycles
- Includes a grease filter and conformal-coated boards
- Easy to use color-coded selectable functions
- Large adaptive control for precise, fine control (slow turns) to spanning the full range in a single twist (fast turns)
- Pan Sense Technology (PST) activates the unit only when a suitable pan is placed on top
- Patterned, glass-ceramic top that is durable, easy to clean and helps scratches from heavy use become less noticeable
- Easy to clean, fully-sealed top, stops grease or moisture from penetrating the unit, even if the top gets broken
- Automatic shut-off to prevent overheating
- Withstands high ambient kitchen temperatures (up to 124°F)
- USB port for downloading updates



IRNG-PC1-36

Close up of patterned black glass-ceramic top – helps prevent noticeable scratches due to heavy use

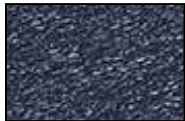

Includes a food temperature probe which facilitates highly accurate cooking

Quick-Ship Model pages 241-247

COUNTERTOP HIGH-POWERED/HEAVY-DUTY INDUCTION RANGES

Model	Item No.	Dimensions W x D x H	Voltage Single Phase	Watts	Ship Weight†	List Price
✓ IRNG-PC1-36	IRNGPC136SB620	13 ⁷ / ₈ " x 18 ⁵ / ₈ " x 3 ³ / ₄ "	208-240	3120-3600	22 lbs.	\$2266

† Shipping weights are approximate.

All Countertop High-Powered/Heavy-Duty Models Feature:
Models Shipped with: A 71" cord and plug and a food temperature probe.
Cord Location: Rear left bottom base corner.

Induction Equipment

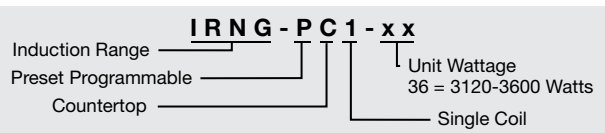



Rapide Cuisine® Drop-In High-Powered/Heavy-Duty Induction Ranges

Hatco's Rapide Cuisine® Drop-In High-Powered/Heavy-Duty Induction Ranges offer industry-leading features and true back-of-house power in a commercial kitchen-proof package.

The unit can be mounted flush or near flush with the optional trim ring. It features our Magnetic Power System (MPS) to deliver the highest power in its class! It has User Programmable Presets (UPP) for repeat menu items and a food temperature probe for more accurate cooking, plus a timer, high resolution color display and convenient power and temperature modes.

- Four surface temperature sensors offer the most accurate control in its class
- Culinary equivalent of up to 31,000 BTUs gas
- High resolution TFT (thin film transistor) display instantly advises the operator of precise power (1 to 100), temperature (°F or °C in one degree increments) and time control (30 seconds to 10 hours)
- Programmable mode so the operator can create preset programs for consistent cooking cycles
- Includes conformal-coated boards
- Easy to use color-coded selectable functions
- Large adaptive control for precise, fine control (slow turns) to spanning the full range in a single twist (fast turns)
- Pan Sense Technology (PST) activates the unit only when a suitable pan is placed on top
- Patterned, glass-ceramic top that is durable, easy to clean and helps scratches from heavy use become less noticeable
- Easy to clean, fully-sealed top stops grease or moisture from penetrating the unit, even if the top gets broken
- Automatic shut-off to safely prevent overheating
- Withstands high ambient kitchen temperatures (up to 124°F)
- USB port for downloading updates



Includes a food temperature probe which facilitates highly accurate cooking

Close up of patterned black glass-ceramic top – helps prevent noticeable scratches due to heavy use

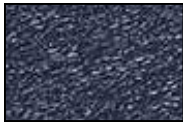

Quick-Ship Model pages 241-247

HIGH-POWERED/HEAVY-DUTY DROP-IN INDUCTION RANGES

Model	Item No.	Dimensions W x D x H	Voltage Single Phase	Watts	Ship Weight†	List Price
✓ IRNG-PB1-36	IRNGPB136SB620	13½" x 14½" x 3 5/8"	208-240	3120-3600	20 lbs.	\$2390

† Shipping weights are approximate.

All Drop-In High-Powered/Heavy-Duty Models Feature:

Models Shipped with: A 51" cable from the base unit to the control panel, a 71" cord and plug, and a food temperature probe.

Cord Location: Rear right bottom base corner.

ACCESSORY (available for purchase at any time)

Holds unit nearly flush on the counter (for use where chair-step routing of a countertop material is not possible, but a flush mount look is desired) –

Trim Ring in Stainless Steel (holds unit nearly

TRIM-PB1-36 flush on a stainless steel or any similar material countertop) **\$63**

Induction Equipment

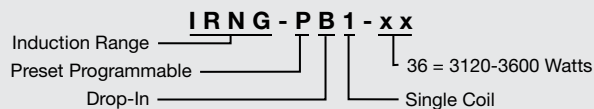

Rapide Cuisine® Countertop High-Powered/Heavy-Duty Dual Induction Ranges

Hatco's Rapide Cuisine® High-Powered/Heavy-Duty Dual Induction Ranges offer industry-leading features and true back-of-house power in a commercial kitchen proof package. These are dual units that are configured either front-to-back or side-to-side to optimize your countertop footprint.

The unit features optimization systems like Magnetic Power System (MPS) to deliver the highest power in its class; safety features like Pan Sense Technology (PST), which means the unit only activates when a pan is present; and convenience features like User Programmable Presets (UPP), where up to six menu items using three stages of cooking can be programmed and saved -- great for repeat menu items. You can also choose a power level and doneness temperature target when using the temperature food probe(s).

More powerful options to suit available power units. The industry leading "IA" models feature Optimal Power Control (OPC) which delivers higher power from lower amperage circuits, boosting power by 25% when needed, and allowing for a double unit on what would normally be a single unit circuit. Allows a double unit to occupy the same linear footprint as a single unit, hence doubling production while remaining within UL standard.

- Food temperature probes for more accurate cooking
- Timers (up to 10 hours, more if in program mode)

- High resolution color displays
- Power (0-100) or temperature (°F or °C modes)
- Heavy gauge stainless steel housing with side impact protection for the top
- Eight surface temperature sensors
- Culinary equivalent of up to 31,000 BTUs gas per burner
- Grease filters
- Highest ambient tolerance on the market 124°F - it's tough
- Numerous options to suit available power circuits, including the unique "IA" models that deliver the highest available power from lower amperage circuits
- USB ports for downloading updates

IRNG-PC2F-36
Front-to-back
configuration shown



IRNG-PC2S-36
Side-to-side configuration shown

Quick-Ship Model pages 241-247

COUNTERTOP HIGH-POWERED/HEAVY-DUTY DUAL INDUCTION RANGES

Model	Item No.	Configuration	Dimensions W x D x H	Voltage Single Phase	Watts (per coil)	Total Power (watts)	Ship Weight†	List Price
Front to Back Ranges								
✓ IRNG-PC2F-29	IRNGPC2F29630	Front to Back	14" x 29 11/16" x 5 1/4"	208-240	2496-2880	4992-5760	41 lbs.	\$4434
✓ IRNG-PC2F-36	IRNGPC2F36650	Front to Back	14" x 29 11/16" x 5 1/4"	208-240	3120-3600	6240-7200	41 lbs.	4925
Front to Back - Input Averaging Ranges								
✓ IRNG-PC2F-24-IA	IRNGPC2F24IA620	Front to Back	14" x 29 11/16" x 5 1/4"	208-240	1803-2400	3606-4800	41 lbs.	\$4657
✓ IRNG-PC2F-36-IA	IRNGPC2F36IA630	Front to Back	14" x 29 11/16" x 5 1/4"	208-240	3120-3600	6240-7200	41 lbs.	5171
Side to Side Ranges								
✓ IRNG-PC2S-29	IRNGPC2S29630	Side to Side	24 7/8" x 19" x 4 1/2"	208-240	2496-2880	4992-5760	40 lbs.	\$4434
✓ IRNG-PC2S-36	IRNGPC2S36650	Side to Side	24 7/8" x 19" x 4 1/2"	208-240	3120-3600	6240-7200	40 lbs.	4925
Side to Side Ranges - Input Averaging Range								
✓ IRNG-PC2S-24-IA	IRNGPC2S24IA620	Side to Side	24 7/8" x 19" x 4 1/2"	208-240	1803-2400	3606-4800	40 lbs.	\$4657
✓ IRNG-PC2S-36-IA	IRNGPC2S36IA630	Side to Side	24 7/8" x 19" x 4 1/2"	208-240	3120-3600	6240-7200	40 lbs.	5171

† Shipping weights are approximate.

All Countertop High-Powered/Heavy-Duty Dual Models Feature:
Models Shipped with: A 7'1" cord and plug and two food temperature probes.
Cord Location: Rear left bottom base corner.



Includes dual food temperature probes which facilitate fast and highly accurate cooking

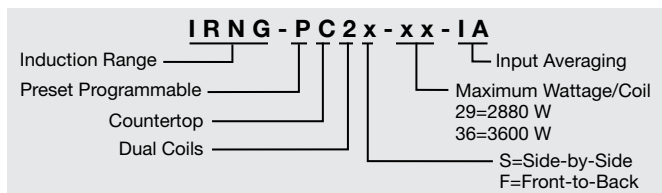



Rapide Cuisine® Drop-In High-Powered/Heavy-Duty Dual Induction Ranges

Hatco's Rapide Cuisine® High-Powered/Heavy-Duty Drop-In Dual Induction Ranges offer industry-leading features and true back-of-house power in a commercial kitchen proof package. These are dual units that are configured either front-to-back or side-to-side to optimize your countertop footprint.

The unit features optimization systems like Magnetic Power System (MPS) to deliver the highest power in its class; safety features like Pan Sense Technology (PST), which means the unit only activates when a pan is present; and convenience features like User Programmable

Presets (UPP), where up to six menu items using three stages of cooking can be programmed and saved - great for repeat menu items. You can also choose a power level and doneness temperature target when using the temperature food probe(s).

More powerful options to suit available power units. The industry leading "IA" models feature Optimal Power Control (OPC) which delivers higher power from lower amperage circuits, boosting power by 25% when needed, and allowing for a double unit on what would normally be a single unit circuit. Allows a double unit to occupy the same linear footprint as a single unit, hence doubling production while remaining within UL standard.

- Food temperature probes for more accurate cooking
- Timers (up to 10 hours, more if in program mode)
- High resolution color displays
- Power (0-100) or temperature (°F or °C modes)
- Heavy gauge stainless steel housing with side impact protection for the top
- Eight surface temperature sensors
- Culinary equivalent of up to 31,000 BTUs gas per burner
- Grease filters
- Highest ambient tolerance on the market 124 °F (51°C)- it's tough
- Numerous options to suit available power circuits, including the unique "IA" models that deliver the highest available power from lower amperage circuits
- USB ports for downloading updates



Includes food temperature probes which facilitate fast and highly accurate cooking

Quick-Ship Model pages 241-247

DROP-IN HIGH-POWERED/HEAVY-DUTY DUAL INDUCTION RANGES

Model	Item No.	Dimensions W x D x H	Voltage Single Phase	Watts (per coil)	Total Power (watts)	Ship Weight†	List Price
✓ IRNG-PB2-29	IRNGPB229630	13 ¹³ / ₁₆ " x 27 ⁹ / ₁₆ " x 6 ¹ / ₄ "	208/240	2496/2880	4992/5760	42 lbs.	\$4159
✓ IRNG-PB2-36	IRNGPB236650	13 ¹³ / ₁₆ " x 27 ⁹ / ₁₆ " x 6 ¹ / ₄ "	208/240	3120/3600	6240/7200	42 lbs.	4362
IA Models							
✓ IRNG-PB2-24-IA	IRNGPB224IA620	13 ¹³ / ₁₆ " x 27 ⁹ / ₁₆ " x 6 ¹ / ₄ "	208/240	1803/2400	3606/4800	42 lbs.	\$4368
✓ IRNG-PB2-36-IA	IRNGPB236IA630	13 ¹³ / ₁₆ " x 27 ⁹ / ₁₆ " x 6 ¹ / ₄ "	208/240	3120/3600	6240/7200	42 lbs.	4582

† Shipping weights are approximate.

All Drop-In High-Powered/Heavy-Duty Dual Models Feature:
Models Shipped with: Two 27½" cables from the base to the control, a 71" cord and plug, and two food temperature probes.
Cord Location: Rear left bottom base corner.

ACCESSORIES (available for purchase at any time)

TRIM-PB2-SS Trim Ring in Stainless Steel (holds unit nearly flush on a stainless steel or any similar material countertop) **\$124**

IRNG - PB 2 - x x - IA



Palletti® Countertop Induction Warmers

Hatco's Palletti® Countertop Professional Induction Warmers offer a safe, efficient and attractive way to keep hot foods hot. Perfect for serving applications such as buffet lines and hospitality suites. The warmer has five simple and precise settings, which allow for a wide variety of foods to be held both safely and at optimum quality. The units are also memory retentive, so once turned off and back on, the last setting will resume.

This unit has a low-profile and ultra-thin design in all black so the focus remains on the food rather than the equipment.

Choose either the stand-alone countertop which offers the greater 600 watts of power for large volumes or the lower watt daisy chain countertop unit where multiple units can be interconnected.

- Adaptable for buffets and many other front-of-the-house applications to give the most attractive and visible food presentations
- Energy efficient, quiet and safe operation with no open flames as with traditional warming presentations

- Elegant, contemporary, low-profile design with a bold black housing and black glass-ceramic top
- Pan Sense Technology (PST) activates the unit only when a suitable pan is placed on top
- Black glass-ceramic top is durable and easy to clean
- Automatic shut-off to safely prevent overheating



IWRM-C1-1317-06

Quick-Ship Model pages 241-247

COUNTERTOP INDUCTION WARMERS

Model	Item No.	Dimensions W x D x H	Voltage Single Phase	Watts	Ship Weight [†]	List Price
✓ IWRM-C1-1317-06	IWRMC113176B515	13" x 17¾" x 2¼"	120	600	12 lbs.	\$1109

[†]Shipping weights are approximate.

All Countertop Induction Warmers Feature:

Models Shipped with: A 71" cord and plug.
Cord Location: Rear right bottom base corner.



IWRM-CD1-03
(Shown with three Daisy Chain Countertop Induction Warmers interconnected to one power cord)

Quick-Ship Model pages 241-247

DAISY CHAIN COUNTERTOP INDUCTION WARMERS

Model	Item No.	Dimensions W x D x H	Voltage Single Phase	Watts	Ship Weight [†]	List Price
✓ IWRM-CD1-03	IWRMCD13B515	13" x 17¾" x 2¼"	120	360	12 lbs.	\$1231

[†] Shipping weights are approximate.

All Daisy Chain Countertop Induction Warmers Feature:

Maximum number of interconnected units: 5 units for US and 4 units for Canada

Models Shipped with: A 71" cord and plug and a 17" interconnecting cord.

Cord Location: Rear right bottom base corner.

Interconnecting Cord Location: Rear left and right bottom base corner.

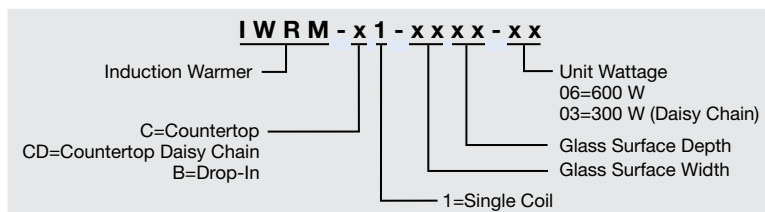



Palletti® Drop-In Induction Warmers

Hatco's Palletti® Drop-In Professional Induction Warmers offer a safe, efficient and attractive way to keep hot foods hot. Perfect for serving applications such as buffet lines and hospitality suites. The warmer has five simple and precise settings, which allow for a wide variety of foods to be held both safely and at optimum quality. The units are also memory retentive, so once turned off and back on, the last setting will resume.

This unit can be mounted flush or near flush with the optional trim ring.

- Adaptable for buffets and many other front-of-the-house applications to give the most attractive and visible food presentations
- Pan sense technology (PST) activates the unit only when a suitable pan is placed on top
- Once installed the glass-ceramic top never needs to be removed. For service or replacement, the lower housing can be removed separately.
- Features a control panel with a standby key, temperature control arrow keys and temperature setting indicators
- Energy efficient, quiet and safe operation
- Choose black or white glass-ceramic top, both are durable and easy to clean
- Features for both safety and convenience, such as the automatic shut-off to prevent overheating
- Includes remote control panel and cord

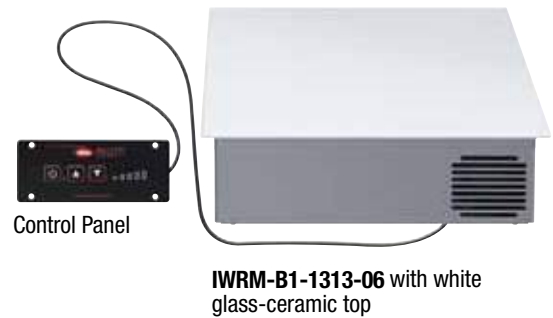
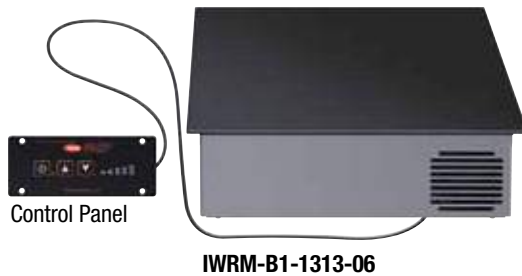

Quick-Ship Model pages 241-247

DROP-IN INDUCTION WARMERS

Model	Item No.	Dimensions W x D x H	Glass-Ceramic Top.	Voltage Single Phase	Watts	Ship Weight [†]	List Price
✓ IWRM-B1-1313-06	IWRMB113136B515	13" x 13" x 4¼"	Black	120	600	13 lbs.	\$1109
✓ IWRM-B1-1313-06	IWRMB113136W515	13" x 13" x 4¼"	White	120	600	13 lbs.	1109

[†] Shipping weights are approximate.

All Drop-In Induction Warmers Feature:

Models Shipped with: A 39" cable from the base to the control and a 71" cord and plug.

Cord Location: Rear left bottom base corner.

ACCESSORIES (available for purchase at any time)

TRIM-IWRM-1B	Trim Ring in Stainless Steel (holds unit nearly flush on a stainless steel or any similar material countertop)	\$57
IWRM-FLUSHBKT	Flush Mount Bracket (Undermount leveling brackets, used with solid material or stainless steel countertop)	74

NOTE: Three installation options for a flush or near-flush look: see manual for details.

Induction Equipment

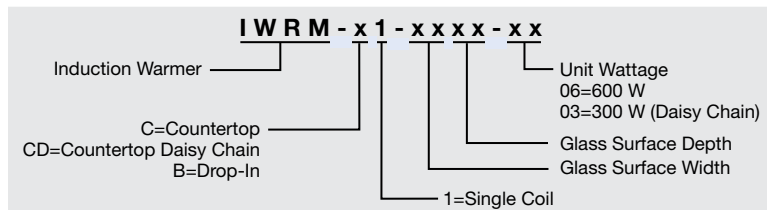

Maskerade™ Undercounter Induction Warmers

Hatco's patent-pending Maskerade™ Undercounter Induction Warmers offer a simple and affordable solution for "invisible" hot food holding under a variety of countertop materials including engineered and natural stone. Perfect for serving applications such as buffet lines and hospitality suites as it eliminates the institutional look of traditional foodwarming equipment yet yields unlimited flexibility.

The warmer has five simple and precise settings, which allow for a wide variety of foods to be held both safely and at optimum quality. The units are also memory retentive, so once turned off and back on, the last setting will resume.

- Can be mounted under a wide variety of countertop materials including engineered and natural stone giving an "invisible" countertop appearance
- Includes one black flexible, highly slip-resistant trivet which locates the chafing dish and protects the stone from the heat of the pan
- Features a control panel with a standby key, temperature control arrow keys a lock key and temperature setting indicators
- Pan Sense Technology (PST) activates the unit only when a suitable pan is placed on the trivet
- Energy efficient, quiet and safe operation
- Features for both safety and convenience, such as the automatic shut-off to prevent overheating
- For easy service, the lower housing can be removed separately

IWRM-UT-06



Quick-Ship Model pages 241-247

UNDERCOUNTER INDUCTION WARMERS

Model	Item No.	Dimensions W x D x H	Voltage Single Phase	Watts (per coil)	Ship Weight†	List Price
✓ IWRM-UT-06	IWRMBUT6515	15¼" x 15" x 3 ⁵ / ₈ "	120	600	17 lbs.	\$1788

† Shipping weights are approximate.

All Undercounter Induction Warmer Models Feature:

Models Shipped with: A 71" cord and plug, a 79" control cable, and a trivet.

Cord Location: Rear left bottom base corner.

ACCESSORIES (available for purchase at any time)

IWRM-TRIVET	Black, flexible slip-resistant trivet (locates the chafing dish and protects the stone)	\$112
-------------	---	-------

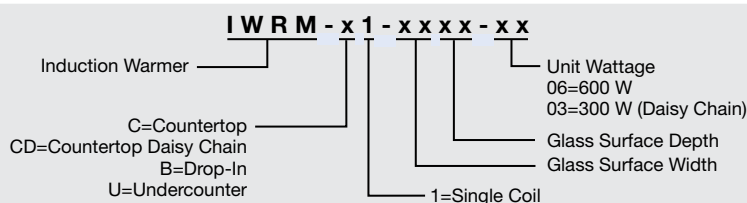

Light Cooking Equipment

*Supermarkets & Delis • Restaurants & Cafés
Clubs & Bars • Concessions*



KCME-1RND with accessory metal spatula *pg. 211*
KSW-1 with three valve bottle *pg. 215*



KWM18-1BU *pg. 213*



KWM18-16CH *pg. 214*



MCG20G with grooved top and bottom plates *pg. 217*



SNACK-2 with accessory Chelky plate *pg. 219*



RWM-2B *pg. 220*



SAL-1 with accessory food pan *pg. 221*

Crepe Makers - Electric

The Hatco®/Krampouz® Crepe Makers are designed for professional use in commercial kitchens or display cooking locations. The adjustable temperature control enables operators to cook excellent, consistent quality crepes from a variety of different batters. The exclusive heating elements combined with a heavy duty, machined cast iron surface provide exceptional heat distribution over the entire griddle for even and fast cooking.

- Stainless Steel frame, with a cast iron griddle, is designed for quality and durability
- Coiled and insulated heating elements create perfect heat distribution across the surface of the plate for consistent, uniform cooking
- Adjustable temperature control of 120° – 570°F
- The KCME-1RND (120V) can be used for up to five hours continuously. The Heavy Duty Crepe Makers are powerful for a full day of breakfast, lunch and beyond
- Single or double griddle crepe makers
- Griddle diameters are 15.75"
- Comes with a spreader and spatula



KCME-1RND, 120V



KCME-1RND, 208-240V



KCME-1RCT



KCME-2RCT

 **Quick-Ship Model** pages 241-247

ELECTRIC CREPE MAKERS

Model	Item Number	Description	Dimensions (W x D x H)	Volts	Watts	Amps	Plug	Ship Weight*	List Price
Single Head, Light Duty									
✓ KCME-1RND*	KCME.1RND515	Single, Round	19 ³ / ₄ " x 18 ¹ / ₄ " x 5 ¹ / ₈ "	120	1740	14.5	NEMA 5-15P	37 lbs.	\$2211
Single Head, Heavy Duty									
✓ KCME-1RND	KCME.1RND620	Single, Round	19 ³ / ₄ " x 17 ⁷ / ₈ " x 6 ⁷ / ₈ "	208-240 ®	2816-3750	13.5-15.6	NEMA 6-20P	51 lbs.	\$3063
✓ KCME-1RCT	KCME.1RCT620	Single, Rectangle	19 ⁵ / ₈ " x 18 ¹ / ₂ " x 7 ³ / ₄ "	208-240 ®	2816-3750	13.5-15.6	NEMA 6-20P	53 lbs.	3552
Double Head, Heavy Duty									
✓ KCME-2RCT*	KCME.2RCT2620	Dual, Rectangle	36 ⁵ / ₈ " x 18 ¹ / ₂ " x 7 ³ / ₄ "	208-240 ®	5632-7500	27.0-31.2	(2) NEMA 6-20P	103 lbs.	\$6045

* Unit weight does not include packaging.

* Not available for Canada.

® Unit is designed to operate on supply voltages between 208V and 240V.

All Hatco/Krampouz Electric Crepe Makers Models Feature:

Cord Location: Under base at center of unit.

ACCESSORIES (available for purchase at any time)

13.75SPATULA	Metal Spatula with plastic handle	\$150
RNDSPREADER	Round Steel Spreader	103
FLATSPREADER	7" Flat Beech Spreader	9
ABRSTONE	Abrasive Cleaning Stone	22
CLEANPAD	Cleaning Pad - with two replaceable cleaning wipes	160
15PADREFILL	Replacement Pads - 15 cleaning wipes	115
CREPECB	Crepe Maker Cookbook	96



13.75SPATULA accessory



RNDSPREADER accessory



FLATSPREADER accessory



ABRSTONE accessory



CLEANPAD accessory



15PADREFILL accessory

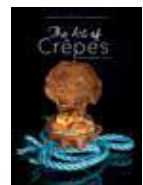

CREPECB accessory

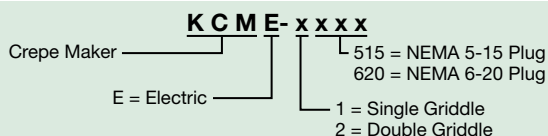



Crepe Makers - Gas

The Hatco®/Krampouz® Crepe Makers are designed for professional use in commercial kitchens or display cooking locations. The adjustable temperature control enables operators to cook excellent, consistent quality crepes from a variety of different batters. Featuring large diameter 8-branch burner(s) that give a temperature range of up to 570°F.

- Single or double griddle crepe makers
- All Gas Crepe Makers come set for natural gas hook-up and includes adapter for propane
- The burner insulation system prevents heat loss and contributes to even heating and cooking performance
- Gas crepe makers are equipped with a heat-activated safety thermocouple that will cut off gas supply to the unit if the burner flame goes out accidentally
- Griddle diameters are 15.75"
- Comes with a spreader and spatula



KCMG-1RND



KCMG-1RCT



KCMG-2RCT

Quick-Ship Model pages 241-247

GAS CREPE MAKERS

Model*	Item Number	Description	Dimensions W x D x H	Burner Power (BTU-HR)	Burner Power (kW)	Manifold Pressure ^c	Burner Orifice Size ^c	Ship Weight	List Price
Propane									
✓ KCMG-1RND	KCMG.1RND22	Single, Round	15¾" x 19" x 7½"	21515	6.3	7 in WC	250 µm	35 lbs.	\$2604
✓ KCMG-1RCT	KCMG.1RCT22	Single, Rectangle	17" x 20½" x 7½"	21515	6.3	7 in WC	250 µm	45 lbs.	2647
✓ KCMG-2RCT	KCMG.2RCT41	Dual, Rectangle	33¾" x 20½" x 7½"	40640	11.9	6.3 in WC	250 µm	90 lbs.	6167

* All units come set for natural gas hook-up, and includes adapter for propane.

^c When converted to Propane, Manifold Pressure and Burner Orifice Sizes change to: KCMG-1RND: 10.9 in WC, 160 µm.
KCMG-1RCT: 10.5 in WC, 160 µm.
KCMG-2RCT: 10.9 in WC, 160 µm.

All Hatco/Krampouz Gas Crepe Makers Models Feature:

Propane Hook-up Location: Back of unit, lower left corner.

ACCESSORIES (available for purchase at any time)

13.75SPATULA	Metal Spatula with plastic handle	\$150
RNDSPREADER	Round Steel Spreader	103
FLATSPREADER	7" Flat Beech Spreader	9
ABRSTONE	Abrasive Cleaning Stone	22
CLEANPAD	Cleaning Pad - with two replaceable cleaning wipes	160
15PADREFILL	Replacement Pads - 15 cleaning wipes	115
CREPECB	Crepe Maker Cookbook	96

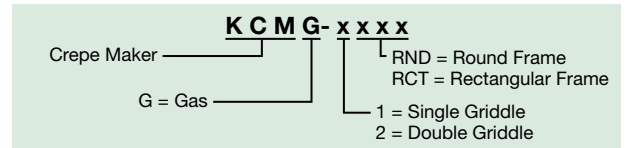

13.75SPATULA
accessory



RNDSPREADER
accessory



FLATSPREADER
accessory



ABRSTONE
accessory



CLEANPAD
accessory



15PADREFILL
accessory



CREPECB
accessory

Waffle Makers/Warmers and Waffle Makers

Hatco®/Krampouz® Waffle Makers/Warmers and Makers make continuous, excellent-quality waffles for commercial kitchens and display cooking locations. The Waffle Makers/Warmers' and Makers' Easy Clean System® provides quick removal and easy cleaning of the waffle plates.

- KWM09 models are designed with 90° hinged waffle plates, for making and warming waffles
- KWM18 models are designed with 180° hinged waffle plates, for cooking waffles from a variety of different batters or doughs
- KWMSL models feature a 180° swivel system that rotates the waffle plates for even heat distribution to make waffles from a variety of different batters or doughs
- Plates can be put right into your dishwasher for easy clean-up
- Drip tray for waste recovery and easy cleaning
- Insulated heating elements create perfect heat distribution across the surface of the plates for consistent, uniform cooking
- Stainless steel frame and cast iron waffle plates are designed for quality and durability
- Adjustable Temperature Control(s) with a range from 120°F–570°F



KWM09-1BR46



KWM18-1BU

easy clean System



KWM18-1R07

KWMSL-2LG413



Quick-Ship Model pages 241-247

ELECTRIC WAFFLE MAKERS/WARMERS AND WAFFLE MAKERS

Model	Item Number	Description	Dimensions (W x D x H)	Volts	Watts	Amps	Plug	Ship Weight*	List Price
90° Hinge, Single Head Waffle Makers/Warmers									
✓	KWM09-1BR46	KWM09.1BR46515	Brussels 4 x 6	15" x 18 ³ / ₄ " x 9 ¹ / ₈ "	120	1440	12.0	NEMA 5-15P	45 lbs. \$3336
✓	KWM09-1BR46	KWM09.1BR46620	Brussels 4 x 6	15" x 18 ³ / ₄ " x 9 ¹ / ₈ "	208-240 ^e	1352-1800	6.5-7.5	NEMA 6-20P	45 lbs. 3336
✓	KWM09-1LG47	KWM09.1LG47515	Liège 4 x 7	15" x 18 ³ / ₄ " x 9 ¹ / ₈ "	120	1440	12.0	NEMA 5-15P	42 lbs. 3336
180° Hinge, Single Head Waffle Makers									
✓	KWM18-1BR35	KWM18.1BR35515	Brussels 3 x 5	16 ⁵ / ₈ " x 23 ¹ / ₄ " x 9 ¹ / ₄ "	120	1440	12.0	NEMA 5-15P	46 lbs. \$3881
✓	KWM18-1BR46	KWM18.1BR46515	Brussels 4 x 6	16 ⁵ / ₈ " x 23 ¹ / ₄ " x 9 ¹ / ₄ "	120	1440	12.0	NEMA 5-15P	46 lbs. 3881
✓	KWM18-1BR46	KWM18.1BR46620	Brussels 4 x 6	16 ⁵ / ₈ " x 23 ¹ / ₄ " x 9 ¹ / ₄ "	208-240 ^e	1352-1800	6.5-7.5	NEMA 6-20P	49 lbs. 3881
✓	KWM18-1LG47	KWM18.1LG47515	Liège 4 x 7	16 ⁵ / ₈ " x 23 ¹ / ₄ " x 9 ¹ / ₄ "	120	1440	12.0	NEMA 5-15P	45 lbs. 3881
✓	KWM18-1LG47	KWM18.1LG47620	Liège 4 x 7	16 ⁵ / ₈ " x 23 ¹ / ₄ " x 9 ¹ / ₄ "	208-240 ^e	1352-1800	6.5-7.5	NEMA 6-20P	45 lbs. 3881
180° Hinge, Single Head Bubble Waffle Maker									
✓	KWM18-1BU	KWM18.1BU515	180° Bubble	16 ⁵ / ₈ " x 23 ⁵ / ₈ " x 9 ¹ / ₈ "	120	1440	12.0	NEMA 5-15P	53 lbs. \$3927
180° Hinge, Dual Head Waffle Makers									
✓	KWM18-2LG47	KWM18.2LG47620	Liège 4 x 7	27" x 23 ⁵ / ₈ " x 9 ¹ / ₈ "	208-240 ^e	2704-3600	13.0-15.0	NEMA 6-20P	72 lbs. \$7234
✓	KWM18-2BR46	KWM18.2BR46620	Brussels 4 x 6	27" x 23 ⁵ / ₈ " x 9 ¹ / ₈ "	208-240 ^e	2704-3600	13.0-15.0	NEMA 6-20P	72 lbs. 7234
90° Hinge, Single Head Round Waffle Maker/Warmer									
✓	KWM09-1R07	KWM09.1R07515	90° Round	15" x 20" x 9 ¹ / ₈ "	120	1440	12.0	NEMA 5-15P	45 lbs. \$3921
180° Hinge, Single Head Round Waffle Maker									
✓	KWM18-1R07	KWM18.1R07515	180° Round	16 ³ / ₈ " x 26 ¹ / ₈ " x 9 ¹ / ₈ "	120	1440	12.0	NEMA 5-15P	53 lbs. \$4587
180° Hinge, Dual Head Rotating Waffle Makers									
✓	KWMSL-2LG413	KWMSL.2LG413620	180° Liège	19 ¹ / ₂ " x 17 ¹ / ₄ " x 16 ¹ / ₄ "	208-240 ^e	1953-2600	9.4-11.3	NEMA 6-20P	68 lbs. \$9047
✓	KWMSL-4BR46	KWMSL.4BR46620	180° Brussels	19 ¹ / ₂ " x 17 ¹ / ₄ " x 16 ¹ / ₄ "	208-240 ^e	1953-2600	9.4-11.3	NEMA 6-20P	68 lbs. 9152

* Shipping weight includes packaging.

^e Unit is designed to operate on supply voltages between 208V and 240V.

All Hatco/Krampouz Electric Waffle Makers/Warmers and Waffle Makers Models Feature:

Cord Location: Under base at center of unit.

ACCESSORIES (available for purchase at any time)

WAFLPICK Metal Forks with Plastic Handle **\$67**



WAFLPICK accessory

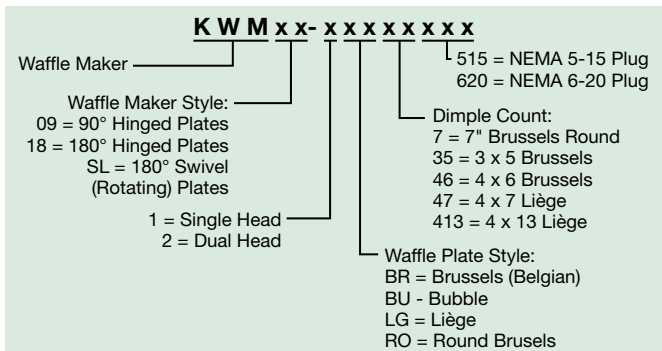



Churro Makers

This professional Hatco®/Kram-pouz® Churro Maker easily makes churros without the need for frying. Great for takeaway service, these finger foods are perfect for dipping in a variety of sauces. Churros are fun, handy sized treats that can be enjoyed as a sweet or savory option for an original snack or appetizer.

- KWM18 models are designed with 180° hinged churro plates for cooking churros from batter or dough
- Stainless steel frame, with cast iron plates, is designed for quality and durability
- Innovative Easy Clean System® allows for instant removal of the churro plates, providing ease of maintenance and increased reliability
- Adjustable Thermostatic Control(s) with a range from 120°F – 570°F allows for precise temperature control
- Also comes with a power indicator, a heating indicator, a removable drip tray and a 6' cord and plug



KWM18-16CH single churro waffle maker



KWM18-32CH dual churro waffle maker

Quick-Ship Model pages 241-247

CHURRO MAKERS

Model	Item Number	Description	Dimensions (W x D x H)	Voltage	Watts	Amps	Plugs	Shipping Weight	List Price
✓ KWM18-16CH	KWM18.16CH515	180°, Single	16 ⁵ / ₈ " x 23 ³ / ₈ " x 9 ¹ / ₈ "	120	1440	12.0	NEMA 5-15P	43 lbs.	\$3486
✓ KWM18-32CH	KWM18.32CH620	180°, Dual	27" x 23 ³ / ₈ " x 9 ¹ / ₈ "	208-240	2704	13.0-15.0	NEMA 6-20P	77 lbs.	6539

All Hatco/Krampouz Churro Waffle Maker Models Feature:

Models Shipped with: cord and plug.
Cord Location: 6CH515 - Bottom left side of unit.
32CH620 - Back of the unit.

ACCESSORIES (available for purchase at any time)

WAFLPICK	Metal Forks with Plastic Handle	\$67
-----------------	---------------------------------	-------------



WAFLPICK accessory

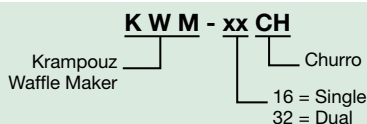

Sauce Warmers

Hatco®/Krampouz® Sauce Warmers are a convenient, attractive way to keep a variety of sauces and toppings warm and ready for use in commercial kitchens and display cooking locations. The adjustable temperature control enables operators to hold a variety of different sauces and toppings.

- Stainless Steel frame is easy to clean and gives you durability and reliability
- On/Off switch with a power indicator light
- Thermostatic control is adjustable from 105° - 195°F
- KSW-2 and -3 features dedicated controls for each bottle well
- Each Sauce Warmer is supplied with the appropriate number of 3-valve sauce bottles



KSW-1 with accessory Bottle



KSW-2 with accessory Bottles



KSW-3 with accessory Bottles

Quick-Ship Model pages 241-247

SAUCE WARMERS

Model	Item Number	Description	Dimensions (W x D x H)	Voltage	Watts	Amps	Plugs	Ship Weight	List Price
✓ KSW-1	KSW.1515	One Bottle Well	6¼" x 8⅞" x 10⅞"	120	170	1.5	NEMA 5-15P	4 lbs.	\$1592
✓ KSW-2	KSW.2515	Two Bottle Well	10¾" x 8⅞" x 10⅞"	120	340	3.1	NEMA 5-15P	7 lbs.	2494
✓ KSW-3	KSW.3515	Three Bottle Well	15¾" x 8⅞" x 10⅞"	120	510	4.6	NEMA 5-15P	11 lbs.	3612

All Hatco/Krampouz Sauce Warmer Models Feature:

Models Shipped with: the appropriate number of 3-valve sauce bottles, cord and plug.
Cord Location: Back of unit, lower left side.

ACCESSORIES (available for purchase at any time)

1VBOTTLE	One valve bottle (designed for thicker sauces, like chocolate)	\$22
3VBOTTLE	Three valve bottle	22

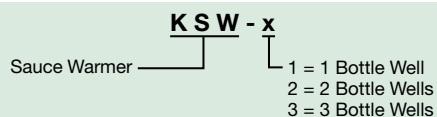



Griddles

Hatco®/Krampouz® Electric and Gas Griddle is designed for commercial kitchens with maximum durability and performance with minimum maintenance. Cook a wide variety of food product in a small footprint. Easy to use, these griddles are perfect for narrow kitchens, confined spaces, and outdoor use.

- All Griddles come set for natural gas hook-up, and includes orifices for propane conversion
- Consists of an easy-to-clean, stainless steel frame, griddle and removable drip tray
- The exclusive, high wattage heating elements provide exceptional heat distribution over the entire griddle for even and fast cooking
- Two cooking areas for variety and speed in your kitchen, with individual adjustable Temperature Control, a Power I/O (On/Off) Switch, and a heating indicator
- Two thermostats with a graduated dial from 120° - 570°F which enable operators to cook food product with different temperature requirements on the same griddle surface



KGRDE-2513



KGRDG-2513

Quick-Ship Model pages 241-247

ELECTRIC GRIDDLE

Model	Item Number	Dimensions W x D x H	Voltage	Cooking Area W x D	Watts	Amps	Plugs	Ship Weight	List Price
✓ KGRDE-2513	KGRDE.2513620	27½" x 15½" x 11¾"	208-240	25¾" x 13¾"	2628-3500	12.6-14.6	NEMA 6-20P	44 lbs.	\$3355

All Hatco/Krampouz Electric Griddle Models Feature:
Cord Location: 6' cord with plug, under base at center of unit.

Quick-Ship Model pages 241-247

GAS GRIDDLE

Model*	Item No.	Dimensions (W x D x H)	Burner Power (BTU/HR)	Burner Power (kW)	Manifold Pressure*	Pressure Regulator Factory SetPoint*	Burner Orifice Size*	Ship Weight	List Price
✓ KGRDG-2513	KGRDG.251314	27½" x 17½" x 11¾"	13648	4	7 in WC	7 in WC	120 µm	49 lbs.	\$3355

* Units come set for natural gas hook-up, and include adapter for propane.

* When converted to propane, Manifold Pressure, Pressure Regulator and and Burner Orifice Size change to: 10.9 in WC, 85 µm

All Hatco/Krampouz Gas Griddle Models Feature:
Gas/Propane Hook-Up Location: Back of unit, lower left corner.

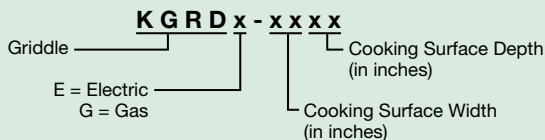

Multi Contact Grills

Hatco's line of light cooking equipment gives you the flexibility of grilling sandwiches with breads of different sizes and thickness, paninis, snacks, vegetables, meats, quesadillas, fish and hamburgers, to name a few.

- Patented heat distribution over entire surface of plates
- Easy Clean System® for quick, efficient cleaning
- Adjustable thermostatically-controlled heated surface

- Additional accessory plates available
- 6' cord with plug attached



MCG10G



MCG14G



MCG20G

Quick-Ship Model pages 241-247

MULTI CONTACT GRILLS

Model	Item No.	Dimensions (W x D x H)	Maximum Product Thickness	Volts	Watts	Amps	Plug	Ship Weight	List Price
Top Grooved, Bottom Grooved (Plates)									
✓ MCG10G*	MCG10G.515P	12 ⁷ / ₈ " x 15 ⁵ / ₁₆ " x 8 ¹ / ₂ "	2 ³ / ₄ "	120	1800	15	NEMA 5-15P	47 lbs.	\$2066
✓ MCG14G*	MCG14G.515P	16 ³ / ₈ " x 15 ⁵ / ₁₆ " x 8 ¹ / ₂ "	2 ³ / ₄ "	120	1800	15	NEMA 5-15P	62 lbs.	2331
✓ MCG14G*	MCG14G.615P.01	16 ³ / ₈ " x 15 ⁵ / ₁₆ " x 8 ¹ / ₂ "	2 ³ / ₄ "	208/240	1950-2600	9.4-10.8	NEMA 6-15P	62 lbs.	2331
✓ MCG20G*	MCG20G.620P.01	25 ¹ / ₂ " x 15 ⁵ / ₁₆ " x 8 ¹ / ₂ "	2 ³ / ₄ "	208/240	2820-3760	13.6-15.7	NEMA 6-20P	93 lbs.	3617
Top Smooth, Bottom Smooth (Plates)									
✓ MCG14S*	MCG14S.515P	16 ³ / ₈ " x 15 ⁵ / ₁₆ " x 8 ¹ / ₂ "	2 ³ / ₄ "	120	1800	15	NEMA 5-15P	62 lbs.	\$2331
✓ MCG14S*	MCG14S.520P	16 ³ / ₈ " x 15 ⁵ / ₁₆ " x 8 ¹ / ₂ "	2 ³ / ₄ "	120	1800	15	NEMA 5-20P	62 lbs.	2331
✓ MCG14S*	MCG14S.615P	16 ³ / ₈ " x 15 ⁵ / ₁₆ " x 8 ¹ / ₂ "	2 ³ / ₄ "	208/240	1950-2600	9.4-10.8	NEMA 6-15P	62 lbs.	2331
Top Grooved, Bottom Smooth (Plates)									
✓ MCG20GS*	MCG20GS.620P	25 ¹ / ₂ " x 15 ⁵ / ₁₆ " x 8 ¹ / ₂ "	2 ³ / ₄ "	208/240	2820-3760	13.6-15.7	NEMA 6-20P [▲]	93 lbs.	\$3617

▲ Canadian models use NEMA 6-20P Item Number MCG20GS.620P.
 * NEMA 5-15P not available in Canada.
 * Unit is designed to operate on supply voltages between 208V and 240V.

All Multi Contact Grill Models Feature:

Cord Location: 6' cord with plug, under base at center of unit.

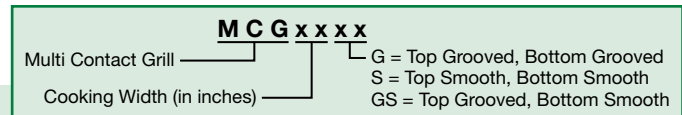

ACCESSORIES (available for purchase at any time)

Smooth Top Enamel Coated Cast Iron Cooking Plate –		
ST-S	For MCG10xx model only	\$454
ST-M	For MCG14xx model only	484
ST-LL	For MCG20xx model only – left side	454
ST-LR	For MCG20xx model only – right side	454
Smooth Bottom Enamel Coated Cast Iron Cooking Plate –		
SB-S	For MCG10xx model only	\$454
SB-M	For MCG14xx model only	484
SB-L	For MCG20xx model only	558
Grooved Top Enamel Coated Cast Iron Cooking Plate –		
GT-S	For MCG10xx model only	\$454
GT-M	For MCG14xx model only	484
GT-LL	For MCG20xx model only – left side	454
GT-LR	For MCG20xx model only – right side	454
Grooved Bottom Enamel Coated Cast Iron Cooking Plate –		
GB-S	For MCG10xx model only	\$454
GB-M	For MCG14xx model only	484
GB-L	For MCG20xx model only	562

Hatco's Patented Heating Element Pack

provides exceptional heat distribution over the entire surface of the plates for control and uniform cooking.

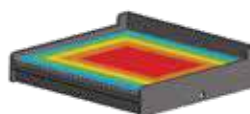

Traditional contact grill

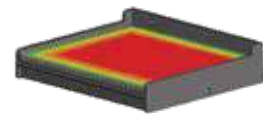

Hatco's patented contact grill

Flip Waffle Maker

Hatco/Suntec Flip Waffle Makers produce excellent, authentic 1¼" thick, round Belgian waffles. Their unique heating elements and 180° swivel mechanism ensure even cooking, while a thermostatic control and a programmable timer deliver consistent, repeatable results. Adjustments to temperature and time can be made to suit any batter and the unit is memory retentive so you may only have to program it once.

- Commercial food service quality – designed for many hours of continuous use, every day
- Heavy duty stainless steel construction with Teflon® coated aluminum plates
- Simple push-button control panel features a stand-by on/off, timer/temperature toggle, higher/lower selection, and start
- Easy to see bright red LED display shows settings and countdown when cooking
- Timer starts automatically when waffle maker is closed and resets when opened, while a beeper signals the end of a cooking cycle
- Fast initial heat up time, excellent heat retention and recovery delivers high productivity
- Models shipped with NEMA 5-15P plug and cord (attached)

Standard Round Belgian Plate 7"



Mini Round Waffle Plate available as accessory Four 3⅝"



FWM-1B

Quick-Ship Model pages 241-247

FLIP WAFFLE MAKER

Model	Item Number	Description	Dimensions (W x D x H)	Voltage	Watts	Amps	Plugs	Shipping Weight	List Price
✓ FWM-1B	FWM1B.515	Round	11⅝" x 22⅞" x 11⅝"	120	1350	11.3	NEMA5-15P	27 lbs.	\$2201

All Hatco/Suntec Flip Waffle Maker Models Feature:

Models Shipped with: cord and plug.
Cord Location: Back of unit, lower left side.

ACCESSORIES (available for purchase at any time)

WM-BRUSH	Nylon Brush	\$20
WAF-FORK	Waffle Fork	7
MINI-WAFFLE	Mini Waffle Plate	88

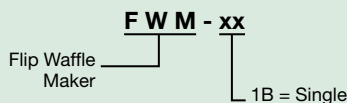

Snack System

The Hatco/Suntec Snack System will help expand your menu and your sales. With a single or dual electric baker, you can easily switch the interchangeable plates to serve breakfast items, lunch foods and a variety of snacks in between. Freshly bake as many or few items as you need, resulting in no waste at the end of the day. Add more variety to your menu in small quantities and increase sales according to the season, time of day and location.

- Four programmable preset buttons for each cooking cycle. A cooking cycle consists of three different settings:
 - Temperature
 - Time
 - Top Cooking Plate Power
- Adjustable time/temperature controls enable operators to cook continuous, consistent quality products
- One-touch release with latch opener for easy plate replacement
- Exclusive heating elements provide exceptional heat distribution throughout the entire cooking plate, ensuring even cooking of each product
- Removable plates are easily cleaned with warm, soapy water
- Compact design is suitable for any location
- Adjustable temperature allows for multiple menu options

NOTE: Comes with standard Round Belgian Waffle Plates and one additional set of plates of your choosing.



SNACK-1 with accessory Chelky plate



SNACK-2 with standard Belgian plate

 **Quick-Ship Model** pages 241-247

SNACK SYSTEM

Model	Item Number	Description	Dimensions (W x D x H)	Voltage	Watts	Amps	Plugs	Shipping Weight	List Price
✓ SNACK-1	SNACK1.515	Single	10 3/4" x 17 7/8" x 8 1/8"	120	900	7.5	NEMA5-15P	23 lbs.	\$1710
✓ SNACK-2	SNACK2.515	Double	21 1/8" x 17 7/8" x 8 1/8"	120	1800	15	NEMA5-15P▲	42 lbs.	2770

▲ Canadian models use NEMA 6-20P Item Number SNACK2.520.

All Hatco/Suntec Snack System Models Feature:

Models Shipped with: a cleaning brush, tool for switching out plates, standard Round Belgian Waffle Plates and an additional set of plates of your choosing.

Cord Location: Back of unit, bottom left-hand side.

ACCESSORIES

(available for purchase at any time)

Interchangeable Cooking Plates –

FREESTYLE	Freestyle Plates	\$285
BELGIAN	Belgian Plates	285
COFFEEBEAN	Coffee Bean Plates	285
SANDWICH	Sandwich Plates	285
PANINI	Panini Plates	285
DONUT	Donut Plates	285
CHELKY	Chelky Plates	285
WM-BRUSH	Nylon Brush	\$20



Freestyle



Belgian



Coffee Bean



Sandwich



Panini



Donut



Chelky



WM-BRUSH
accessory

SNACK - x

Snack System ——— | 1 = Single Head
| 2 = Dual Head



Round Waffle Makers

Hatco®/Suntec Round Waffle Makers cook continuous, excellent-quality waffles for commercial kitchens, display cooking locations, and buffets. The adjustable time and temperature controls enable operators to cook consistent quality waffles from a variety of different batters.

- Exclusive heating elements provide exceptional heat distribution throughout the entire cooking plate, ensuring even cooking of each waffle
- Stainless steel frame, cast aluminum cooking plates
- Belgian-style cooking plates produce 1" thick waffles
- LED display shows timer, temperature and status information
- Simple push button control panel featuring a stand-by On/Off, timer/temp toggle, higher/lower selection, and start/stop
- Fast initial heat-up time, excellent heat retention and recovery delivers high productivity and consistent results



RWM-2



RWM-1B

Quick-Ship Model pages 241-247

ROUND WAFFLE MAKERS

Model	Item Number	Description	Dimensions W x D x H	Voltage	Watts	Amps	Plugs	Shipping Weight	List Price
✓ RWM-1	RWM1.515	Single, Round, Standard	9 ⁵ / ₈ " x 17 ³ / ₄ " x 8 ¹ / ₈ "	120	900	7.5	NEMA 5-15P	16 lbs.	\$1008
✓ RWM-1B	RWM1B.515	Single, Round, Belgian	9 ⁵ / ₈ " x 17 ³ / ₄ " x 8 ¹ / ₈ "	120	900	7.5	NEMA 5-15P	16 lbs.	1008
✓ RWM-2	RWM2.515	Double, Round, Standard	19 ⁵ / ₈ " x 17 ³ / ₄ " x 8 ¹ / ₈ "	120	1800	15	NEMA 5-15P	33 lbs.	1755
✓ RWM-2B	RWM2B.515	Double, Round, Belgian	19 ⁵ / ₈ " x 17 ³ / ₄ " x 8 ¹ / ₈ "	120	1800	15	NEMA 5-15P	33 lbs.	1755

▲ Canadian model uses NEMA 5-20P with different Item Number.

All Hatco/Suntec Round Waffle Maker Models Feature:

Models Shipped with: Stainless Steel frame and aluminum cooking plates, On/Off power switch, multi-function control panel, removable drip tray, nylon brush and a 6' cord and plug.

Cord Location: Back of unit, lower left corner

ACCESSORY

(available for purchase at any time)

WM-BRUSH Nylon Brush \$20

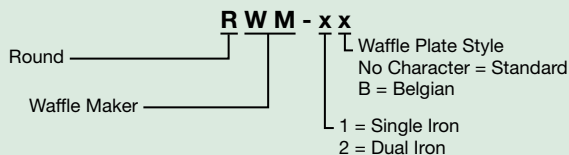

Electric Salamander

Hatco's Electric Salamander gives you versatility in the kitchen with the capability to cook, grill, reheat and keep foods hot. The plate detection feature activates the instant-on heating elements automatically when a food plate comes into contact with the plate detection bar.

- Three independently-controlled Instant-On heating elements provide the benefits of on-demand cooking and energy conservation
- Adjustable upper housing gives 4½" of vertical movement for maximum versatility
- Features high-powered infrared ribbon heating elements
- Heating elements are on only when a cook or hold cycle has been activated, eliminating residual heat in the kitchen environment
- The HOLD function has eight programmable heat levels and is ideal for keeping food hot or for reheating food
- Features a flat, touch control panel and stainless steel construction



ELECTRIC SALAMANDER

Model	Dimensions W x D x H*	Cooking Area W x D	Voltage Single Phase	Watts	Amps	Plug	Ship Weight	List Price
SAL-1	22¾" x 21¾" x 23 ⁷ / ₈ "	21 ⁷ / ₈ " x 13¾"	208	4500	21.6	NEMA 6-30P	143 lbs.	\$7278
SAL-1	22¾" x 21¾" x 23 ⁷ / ₈ "	21 ⁷ / ₈ " x 13¾"	240	4500	18.8	NEMA 6-30P	143 lbs.	7278

* Height includes 4" legs. Add 2" to depth for wall mounted units.

All Electric Salamander Models Feature:

Models Shipped with: Cooking grate, drip pan, wall mounting hardware, 4" adjustable black plastic legs and cord & plug.

Power Inlet Location: Back of unit, lower right corner.

OPTIONS (available at time of purchase only)

SAL-HW Hardwiring (in lieu of standard 4' Cord and Plug) **No Charge**

FOOD PANS AND TRIVETS – PAGE 240

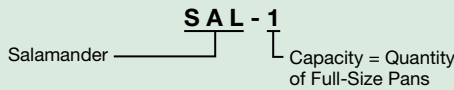

**Saves Energy,
Saves Money,
Protects your Reputation!**

Do your bit for Global Warming with Hatco's SAL-1. The Hatco Electric Salamander's elements are ready for use in just eight seconds. How does that work? Mounted on the back wall of the Salamander is a "plate detection" switch that keeps the unit from turning on unless a plate or pan is put underneath, against this bar. That means the elements are only on when they need to be. Most kitchens have every piece of equipment on all day, firing out heat and constantly using energy. Even in power save mode, most equipment is never fully off. Not the Electric Salamander. It's 100% off when not in use, saving money, energy and the environment.

Water Heating/ Specialty Equipment

*Cafeterias • Convenience Stores
Supermarkets & Delis • Restaurants & Cafés
Clubs & Bars • Catering • Concessions*



3CS-9B with optional temperature monitor
pg. 224



FR-9 *pg. 226*



PMG-100 *pg. 228*



PMG-200 with optional Stainless Steel body
and base, and accessory Stainless Steel
legs *pg. 228*



C-27 *pg. 230*



S-57 with optional Stainless Steel body and base,
and accessory Stainless Steel legs *pg. 232*

Atmospheric Hot Water Dispenser

At a simple push of a button, the Hatco Atmospheric Hot Water Dispenser delivers pre-measured quantities of hot water for food preparation or cleaning. The compact, durable design uses minimal counter space, while providing up to 8 gallons of continuous hot water. The removable shelf allows access to dispense water into larger containers.

- Quickly delivers 2, 3 or 4 quarts of hot water with the touch of a button
- Program can be interrupted for versatility and convenience
- Manual dispense button for additional water volume options
- 12 gallon stainless steel tank is emptied easily with convenient bottom drain
- Hot water ready in as little as 15 minutes



AWD-12 Pitcher not available

ATMOSPHERIC HOT WATER DISPENSER

Model	Dimensions W x D x H*	kW	Voltage	Phase	Plug	Ship Weight	List Price
AWD-12	13 ³ / ₈ " x 27 ¹ / ₂ " x 28 ¹ / ₈ "	5.0	208 or 240	1	NEMA 6-30P	105 lbs.	\$6136

* Height includes 4" legs.

All Hot Water Dispenser Models Feature:

Models Shipped with: Low-water cut-off (LWCO), high temperature limit, electronic temperature controller and digital temperature display.

Distance Between Shelf and Spout: 11³/₄".

Cord Location: Lower left corner on left side.

WATER QUALITY REQUIREMENTS – PAGE 248

WATER TEMPERATURE RECOVERY TABLE

Degrees of Rise										
60°F (33°C)	70°F (39°C)	80°F (44°C)	90°F (50°C)	100°F (55°C)	110°F (61°C)	120°F (66°C)	130°F (72°C)	140°F (78°C)	150°F (83°C)	160°F (88°C)
33 gph (125 lph)	29 gph (110 lph)	25 gph (95 lph)	22 gph (83 lph)	20 gph (75 lph)	18 gph (68 lph)	17 gph (64 lph)	15 gph (57 lph)	14 gph (53 lph)	13 gph (49 lph)	12 gph (45 lph)

gph = gallons per hour
lph = liters per hour

COLD-START HEAT-UP TIME

Degrees of Rise		
60°F (33°C)	90°F (50°C)	140°F (78°C)
22 Minutes	33 Minutes	52 Minutes

WATER TEMPERATURE RECOVERY TIME

Degrees of Rise		
60°F (33°C)	90°F (50°C)	140°F (78°C)
15 Minutes*	22 Minutes*	35 Minutes*

* Recovery times are after 10 gallons (37 liters) of water have been dispensed

OPTIONS (available at time of purchase only)

WALLMOUNT	Wall-Mounting Shelf	\$525
AWD-L6	NEMA L6-30P Locking Cap in lieu of NEMA 6-30P	add 20

ACCESSORIES (available for purchase at any time)

AWD-FILTER	Water Filtration Cartridge for premium quality water (recommended filter change every 15,000 gallons) – Incoming water must be 100°F or less	\$564
AWD-PLUMB	3' Rubber Drain Hose with 10' 1/4" Inlet Tubing	88



AWD-FILTER Accessory
Provides a superior balance of chlorine, taste, and odor reduction. Inhibits limescale build-up

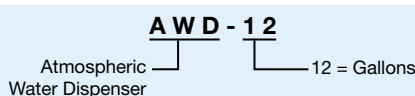



July 1, 2022

3CS Sanitizing Sink Heaters

Maintaining a continuous supply of sanitizing rinse water without taking up valuable space, the 3CS makes manual warewashing faster and more convenient. Drain may be plumbed to open-sight waste drain. A special 3CS Sink Heater is available for shipboard use under military spec (MiL-H-43895B) – consult factory for prices.

- Stainless steel front, powdercoated silver-gray hammertone body and convenient side drain
- Equipped with an Energy Cut-Off (ECO) for built-in protection against higher-than-normal water temperature
- An On/Off toggle switch with indicator light to indicate power status, and a red light to indicate the need to refill and reset the unit
- Meets NSF standard of 180°F for dish sanitizing



3CS-9 with optional temperature monitor

Quick-Ship Model pages 241-247

SANITIZING SINK HEATERS

Model	kW	Sink Area	Voltage	Phase	Ship Weight	List Price	
						208 or 240V	480V
3CS-3	3.0	15" Sq. or less	208, 240, 480	1	24 lbs.	\$2886	\$2998
3CS-4	4.5	16"-18" Sq.	208, 240, 480	1	24 lbs.	2906	3018
✓ 3CS-6*	6.0	19"-21" Sq.	208, 240, 480	1 or 3	26 lbs.	2961	3073
✓ 3CS-9*	9.0	21"-25" Sq.	208, 240, 480	1 or 3	27 lbs.	3066	3178
3CS-3B	3.0	15" Sq. or less	208, 240, 480	Balanced 3	30 lbs.	3286	3398
3CS-4B	4.5	16"-18" Sq.	208, 240, 480	Balanced 3	30 lbs.	3286	3398
3CS-6B	6.0	19"-21" Sq.	208, 240, 480	Balanced 3	30 lbs.	3286	3398
3CS-9B	9.0	21"-25" Sq.	208, 240, 480	Balanced 3	33 lbs.	3286	3398

* Open delta on 3-phase. Larger circuit required than for balanced 3-phase of equal kW.

All Sink Heater Models Feature:

Dimensions 3CS-3, -4, -6, -9: 6¾"W x 16⅞"D x 12⅝"H.

3CS-9 480V, 3CS-3B, -4B, -6B, -9B: 8"W x 17⅞"D x 12⅝"H.

Models Shipped with: Stainless steel front, silver gray hammertone body and black base.

3CS Heaters can be shipped FED-EX GROUND or United Parcel Service.

WATER QUALITY REQUIREMENTS – PAGE 248

OPTIONS (available at time of purchase only) (not available on Quick-Ship)

SSBB	All Stainless Steel Body and Base	\$135
TEMP MON*	Temperature Monitor (Built-In)	139
TEMP LIGHT*	Temperature Light	106
CSA-WIRE	CSA Wiring (Canadian models only)	70
FR-SECURITY	Security Package (Torx® Screws and Control Cover)	204
MIL-H-43895B	Shipboard use	Consult Factory for Pricing

ACCESSORIES (available for purchase at any time)

FR-FLUSH	Flush Hose, Stopper and Adapter	\$91
----------	---------------------------------	------

* Specify either monitor or light, not both.



FR-FLUSH Accessory

SIZING INFORMATION

For a Sink Heater: 2000 WATTS PER SQUARE FOOT of vessel top.

3CS Sink Heaters are sized based on 140°F supply water with a 30 minute preheat period to reach the sanitizing temperature. Sink Heaters are mounted into the third compartment sink with standard plumbing fittings provided. Two 2" diameter holes are required for these fittings and a full size template is provided to locate holes in the sink. The 3CS Sink Heater is easily attached to the plumbing fittings with self-contained unions.

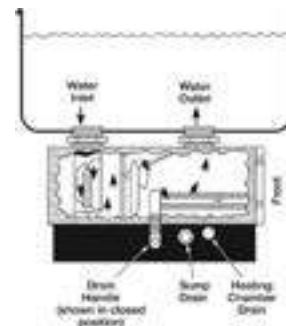

3CS - x B

Three Compartment Sink ——— Balanced 3-Phase
Kilowatt Rating

3CS2 Hydro-Heater Sanitizing Sink Heaters

The patented Hatco 3CS2 Hydro-Heater concept features a tubular water chamber with heating elements uniquely wrapped outside the flow tube so elements do not come in contact with the water, eliminating sediment and lime buildup, resulting in longer life. An electronic controller with digital display maintains an accurate setpoint temperature.

- Utilizes “free-flow” technology and advanced electronic controls to assure responsive and efficient operation
- Stainless steel front, powdercoated body, convenient drain outlet and clean-out caps



3CS2-3
with optional
auto-fill solenoid

SANITIZING SINK HEATERS

Model	kW	Dimensions		Sink Area	Voltage	Phase	Ship Weight	List Price
		W x D x H						
3CS2-3	3	7 ³ / ₄ "	17 ¹ / ₈ " x 12 ⁵ / ₈ "	15" Sq. or less	208	1	31 lbs.	\$3466
3CS2-4	4	7 ³ / ₄ "	17 ¹ / ₈ " x 12 ⁵ / ₈ "	16"-18" Sq.	208, 240	1	31 lbs.	3501
3CS2-6	6	7 ³ / ₄ "	17 ¹ / ₈ " x 12 ⁵ / ₈ "	19"-21" Sq.	208	1	31 lbs.	3756
3CS2-3B	3	7 ³ / ₄ "	17 ¹ / ₈ " x 12 ⁵ / ₈ "	15" Sq. or less	208, 240	Balanced 3	35 lbs.	3891
3CS2-4B	4	7 ³ / ₄ "	17 ¹ / ₈ " x 12 ⁵ / ₈ "	16"-18" Sq.	208, 240	Balanced 3	35 lbs.	3891
3CS2-6B	6	7 ³ / ₄ "	17 ¹ / ₈ " x 12 ⁵ / ₈ "	19"-21" Sq.	208, 240	Balanced 3	35 lbs.	3891
3CS2-9B	9	7 ³ / ₄ "	17 ¹ / ₈ " x 12 ⁵ / ₈ "	21"-25" Sq.	208	Balanced 3	35 lbs.	3891

All Sink Heater Models Feature:

Models Shipped with: Stainless steel front, powdercoated body, low-water cut-off (LWCO) and electronic temperature monitor. 3CS2 Heaters can be shipped **FED-EX GROUND** or **United Parcel Service**.

WATER QUALITY REQUIREMENTS – PAGE 248

OPTIONS (available at time of purchase only)

SSBODY	All Stainless Steel Body and Base	\$135
AUTOFILL	Auto-fill Solenoid	408
REMOTE	Remote Mounted Control	327
HH-SECURITY	Security Package (Torx® Screws and Control Cover)	204

ACCESSORIES (available for purchase at any time)

FR2-FLUSH	Flush Hose, Cleaning Brush, Stopper and Adapter	\$106
------------------	---	--------------



FR2-FLUSH Accessory

SIZING INFORMATION

For a Sink Heater: 2000 WATTS PER SQUARE FOOT of vessel top.

3CS2 Sink Heaters are sized based on 140°F supply water with a 30 minute preheat period to reach the sanitizing temperature. Sink Heaters are mounted in the center of the third compartment sink with standard plumbing fittings provided. Two 2" diameter holes are required for these fittings and a full size template is provided to locate holes in the sink. The 3CS2 Sink Heater is easily attached to the plumbing fittings with self-contained unions.

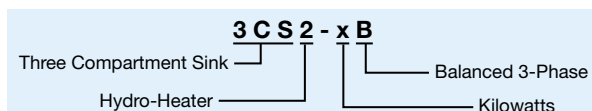



July 1, 2022

FR Food Rethernalizer/ Bain-Marie Heaters

The Hatco FR is a Bain-Marie or food reconstitutor to heat or hold foods at safe temperatures between 140° and 190°F. All models are shipped factory assembled, pre-wired and include standard 2" stainless steel plumbing fittings for mounting into a holding tank. Drain may be plumbed to open-sight waste drain.

- Equipped with an Energy Cut-Off (ECO) for built-in protection against higher-than-normal water temperature
- Stainless steel tank with five year limited warranty
- Optional low-water cut-off (LWCO) available to prevent element burn out from low-water conditions
- Separate sump and heating compartment drains for cleaning and sanitizing



FR-9

Quick-Ship Model pages 241-247

FOOD RETHERMALIZER/BAIN-MARIE HEATERS

Model	kW	Voltage	Phase	Ship Weight	List Price	
					208 or 240V	480V
FR-3	3.0	208, 240, 480	1	24 lbs.	\$2646	\$2758
FR-4	4.5	208, 240, 480	1	24 lbs.	2676	2788
FR-6*	6.0	208, 240, 480	1 or 3	28 lbs.	2951	3063
FR-9*	9.0	208, 240, 480	1 or 3	28 lbs.	3026	3138
FR-3B	3.0	208, 240, 480	Balanced 3	30 lbs.	3236	3348
FR-4B	4.5	208, 240, 480	Balanced 3	32 lbs.	3236	3348
FR-6B	6.8	208, 240, 480	Balanced 3	30 lbs.	3236	3348
FR-9B	9.0	208, 240, 480	Balanced 3	30 lbs.	3236	3348

- ✓ Quick-Ship models do NOT include low-water cut-off option.
- Open delta on 3-phase. Larger circuit required than for balanced 3-phase of equal kW.

All Food Rethernalizer Models Feature:

Dimensions: FR-3, -4, -6, -9: 6¼"W x 16⅞"D x 12¼"H.

FR Models with 480V and Low Water Cut-Off: 8"W x 17⅞"D x 12¼"H.

FR-3B, -4B, -6B, -9B: 8"W x 17⅞"D x 12¼"H.

Models Shipped with: Stainless steel front, silver gray hammertone body and black base.

FR Heaters can be shipped FED-EX GROUND or United Parcel Service.

WATER QUALITY REQUIREMENTS – PAGE 248

OPTIONS (available at time of purchase only) (not available on Quick-Ship)

SSBB	All Stainless Steel Body and Base	\$135
W/LW	Low-Water Cut-Off	227
CSA-WIRE	CSA Wiring (Canadian models only – not available with Cord and Plug)	70
FR-SECURITY	Security Package (Torx® Screws and Control Cover)	204

ACCESSORIES (available for purchase at any time)

FR-FLUSH	Flush Hose, Stopper and Adapter	\$91
----------	---------------------------------	------



FR-FLUSH Accessory

SIZING INFORMATION

For a Bain-Marie or steam table: MINIMUM 750 WATTS PER SQUARE FOOT of vessel top.

For a Food Rethernalizer: MINIMUM 2000 WATTS PER SQUARE FOOT of vessel top.

Use one FR for a Bain-Marie up to 6' long. Units over 6' require a minimum of two FRs. (Tank Baffle supplied by installer.)

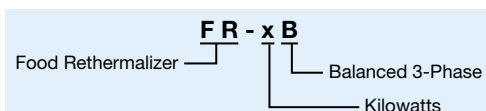
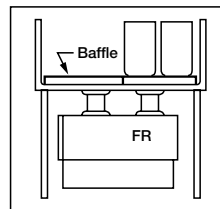

FR2 Hydro-Heater Food Rethernalizer/ Bain-Marie Heaters

The patented Hatco FR2 Hydro-Heater concept features a tubular water chamber with heating elements uniquely wrapped outside the flow tube so elements do not come in contact with the water, eliminating sediment and lime buildup, resulting in longer life. An electronic controller with digital display maintains an accurate setpoint temperature.

- Utilizes “free-flow” technology and advanced electronic controls to assure responsive and efficient operation
- Stainless steel front, powdercoated body, convenient drain outlet and clean-out caps



FR2-3 with optional
Stainless Steel body and base

FOOD RETHERMALIZER/BAIN-MARIE HEATERS

Model	Dimensions W x D x H	kW	Voltage 50/60Hz	Phase	Ship Weight	List Price
FR2-3	7¾" x 17½" x 12¾"	3	208	1	34 lbs.	\$3461
FR2-4	7¾" x 17½" x 12¾"	4	208, 240	1	34 lbs.	\$501
FR2-6	7¾" x 17½" x 12¾"	6	208	1	34 lbs.	\$741
FR2-3B	7¾" x 17½" x 12¾"	3	208, 240	Balanced 3	34 lbs.	\$886
FR2-4B	7¾" x 17½" x 12¾"	4	208, 240	Balanced 3	34 lbs.	\$886
FR2-6B	7¾" x 17½" x 12¾"	6	208, 240	Balanced 3	34 lbs.	\$886
FR2-9B	7¾" x 17½" x 12¾"	9	208	Balanced 3	34 lbs.	\$886

All Food Rethernalizer Models Feature:

Models Shipped with: Stainless steel front, powdercoated body, low-water cut-off (LWCO) and electronic temperature monitor.
FR2 Heaters can be shipped FED-EX GROUND or United Parcel Service.

WATER QUALITY REQUIREMENTS – PAGE 248

OPTIONS (available at time of purchase only)

SSBODY	All Stainless Steel Body and Base	\$135
AUTOFILL	Auto-fill Solenoid	408
REMOTE	Remote Mounted Control	327
HH-SECURITY	Security Package (Torx® Screws and Control Cover)	204

ACCESSORIES (available for purchase at any time)

FR2-FLUSH	Flush Hose, Cleaning Brush, Stopper and Adapter	\$106
-----------	---	--------------



FR2-FLUSH Accessory

SIZING INFORMATION

For a Bain-Marie or steam table: MINIMUM 750 WATTS PER SQUARE FOOT of vessel top.

For a Food Rethernalizer: MINIMUM 2000 WATTS PER SQUARE FOOT of vessel top.
Use one FR2 for a Bain-Marie up to 6' long. Over 6', minimum two required.

MUST BE INSTALLED WITH A PERFORATED WATER BAFFLE. This baffle is not supplied with heater. The FR2 should be positioned with no more than 3' on either side when mounted in holding vessel. Consult factory or installation manual for fabricating details.

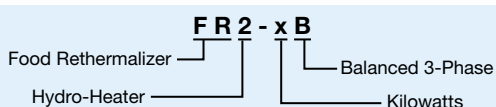



July 1, 2022

Powermite® Gas Booster Water Heaters

The Powermite® Gas Booster Water Heater provides 180°F sanitizing hot water and long life dependability. Models can be supplied to operate on either natural or propane gas and feature a burner system that utilizes both primary and secondary air for consistent ignition. Available for U.S. and Canada only.

- Features stainless steel tanks – front and top, powdercoated sides and back, finned tube copper heat exchanger, temperature relief valve, pressure reducing valve, two temperature/pressure gauges, blended phosphate water treatment system, shock absorber and low-water cut-off (LWCO)
- Spark to light with standing pilot
- PMG-100 has 3 tube type burners, and PMG-200 has 6 tube type burners



PMG-100

Quick-Ship Model pages 241-247

GAS BOOSTER WATER HEATERS

Model*	Input BTUs/Hour	Output	Dimensions W x D x H*	Ship Weight	List Price
✓ PMG-100	105,000	84,800 = 24.8kW	27½" x 20¾" x 31"	193 lbs.	\$17041
✓ PMG-200	195,000	156,000 = 45.7kW	36" x 20¾" x 31"	228 lbs.	20216

* Quick Ship Models are manufactured with orifice kits up to 2000 ft elevation. Higher elevations are production units - please note the elevation on order.
• Height includes legs. Width & depth does not include temperature pressure relief valve dimensions.

All Gas Booster Models Feature:

Electrical Supply: 120 VAC, 360 watt, 3.00 amp.

Connections: Gas – ¾" NPT, Water – ¾" NPT, Electric – 120 VAC, 15 amp.

Fuel: Standard – Natural gas. Optional – Propane gas.

Models Shipped with: Stainless steel tank/front/top, powdercoated sides and back, blended phosphate water treatment system, low-water cut-off (LWCO), temperature/pressure relief valve, pressure reducing valve, shock absorber, two temperature/pressure gauges, indicator light and On/Off switch.

Water Capacity: 4¾ gallons.

Natural Gas Inlet Pressure Inches Water Column: Min. – 5.0. Max. – 10.5.

Propane/LP Gas Inlet Pressure Inches Water Column: Min. – 11.0. Max. – 13.0.

Operating Pressure Specifications at Manifold –

Inches Water Column at Pressure Tap: Natural Gas – 3.5. Propane/LP Gas – 10.0.

Direct Fluing: Combustion air enters bottom, flue gasses exit right side or back at top of unit.

Vent^: Forced draft system with 4" diameter vent pipe adapter.

^ Before installing any method of venting contact the local code authority or gas supplier to make sure the final installation will be acceptable to the authorities who have jurisdiction. See Installation Manual at www.hatcocorp.com for more venting information.

NOTE: Pages 236-238 for sizing information.

WATER QUALITY REQUIREMENTS – PAGE 248

OPTIONS (available at time of purchase only) (not available on Quick-Ship)

Stainless Steel Body and Base –

SSBB	PMG-100	\$280
SSBB	PMG-200	340
PMG-SECURITY	Security Package (Torx® Screws and Control Cover)	\$204

ACCESSORIES (available for purchase at any time)

✓ QSFLOORMOUNT	Additional Stainless Steel Floor Mounting Leg Assembly	\$374
✓ QSBPRV	Back Pressure Relief Valve (page 234 for illustration)	215
✓ QSPRVB	Additional Brass Pressure Reducing Valve with Bypass	211
✓ QSSA-LEGS	Additional Stainless Steel Adjustable Legs (6"-7")	240
PMG-AI	Air Interlock Switch	214
ORIF	High Altitude Kit for gas and elevation – applicable at 2000 feet and above (PMG-200 only)	No Charge

NOTE: 6" plastic adjustable legs (6"-7") standard. Description of accessories is shown on page 234.



PMG-AI
Accessory



ORIF Accessory

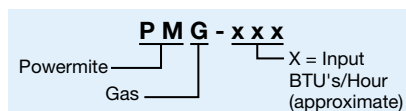

Mini-Compact Electric Booster Water Heaters

The Mini-Compact specialty heater features a stainless steel tank and fast recovery, making it ideal for hot water sanitizing. This heater includes stainless steel front with powdercoated silver gray hammertone body, black base, 6" legs and a storage capacity of 3.2 gallons.

- Provides 180°F water for hot water sanitizing
- Features temperature/pressure relief valve, a pressure reducing valve, two temperature/pressure gauges, a high-temperature limit control and a low-water cut-off (LWCO)



MC-10

SPECIALTY ELECTRIC BOOSTER WATER HEATERS

Model	Dimensions (W x D x H)	kW	Voltage	Phase	Ship Weight	List Price	
						208 or 240V	480V
MC-10*	11¾" x 12⅞" x 18½"	9.9	208	1, 3	48 lbs.	\$3761	—
MC-11*	11¾" x 12⅞" x 18½"	11.4	240, 480	1, 3	48 lbs.	3761	\$3817
MC-15	11¾" x 12⅞" x 18½"	15	208	3	49 lbs.	4071	—
MC-17	11¾" x 12⅞" x 18½"	17.25	208	3	48 lbs.	4116	—

* Must specify phase. Not field-convertible.

All Specialty Water Heater Models Feature:

Models Shipped with: Low-water cut-off (LWCO), temperature/pressure relief valve, pressure reducing valve and two temperature/pressure gauges.

WATER QUALITY REQUIREMENTS – PAGE 248

OPTIONS (available at time of purchase only)

MC-TOGGLE	Built-In On/Off Toggle Switch (does not include Indicator Light, cannot be combined with Security Package)	\$ 78
MCL-SSJA	Stainless Steel Body and Base	156

ACCESSORIES (available for purchase at any time)

✓ QSWATERTREAT	Blended Phosphate Injection System – not for potable water use (page 234 for Illustration)	\$966
✓ QSSHOCK	Shock Absorber to reduce water hammer	138
✓ QSPRVB	Additional Brass Pressure Reducing Valve	211
✓ QSSSA-LEGS	Additional Stainless Steel Adjustable Legs (6"-7")	240

NOTE: 6" plastic adjustable legs (6"-7") standard. Description of accessories is shown on page 234.

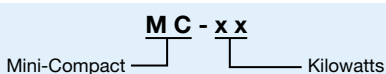



July 1, 2022

Compact Electric Booster Water Heaters

Compact models provide all the 180°F final rinse water to sanitize and flash-dry dishes and flatware. Models include stainless steel front panel, silver gray hammertone body, black base and standard 6" plastic legs. Slide brackets for mounting under a dishtable are available. The Castone® lined tank is standard on all models and has a six gallon capacity.

- The Compact Electric Booster is easy to install next to a dishwasher to save space, either on 6" plastic legs or with accessory slide brackets
- All models include a Castone® lined tank with a 10-year limited warranty, and fiberglass insulation to minimize heat loss
- Swing-away front panels with low-water cut-off (LWCO), control fuses and transformer allow quick access to probes and elements, for easier serviceability



C-18 with optional Stainless Steel body and base



C-45

NOTE: Single phase is uncommon in heaters 24kW and larger and are NOT returnable.

Quick-Ship Model pages 241-247

COMPACT ELECTRIC BOOSTER WATER HEATERS

Model*	kW	208V			240V		480V Three Ph	Ship Weight	List Prices	
		Single Ph	Single Ph	Three Ph	Three Ph	208 or 240V			480V	
Small										
C-4	4	✓					115 lbs.	\$3831	\$3831	
C-5	5	✓					115 lbs.	3881	3881	
C-6	6	✓	✓		✓		118 lbs.	3951	3951	
C-7	7	✓	✓	✓	✓		118 lbs.	4006	4006	
C-9	9	✓	✓	✓	✓		118 lbs.	4046	4046	
C-12	12	✓	✓	✓	✓		120 lbs.	4281	4281	
C-13	13.5						120 lbs.	4311	4311	
C-15	15	✓	✓	✓	✓		120 lbs.	4366	4366	
C-17	17.25			✓			120 lbs.	4396		
C-18	18						120 lbs.	4431	4431	
Large										
C-24	24			✓			142 lbs.	\$5896	\$5896	
C-27	27			✓	✓		142 lbs.	5986	5986	
C-30	30			✓	✓	✓	142 lbs.	6041	6041	
C-36	36			✓	✓	✓	142 lbs.	6316	6236	
C-39	39						142 lbs.	6431	6346	
C-45	45			✓	✓	✓	142 lbs.	7156	7066	
C-54	54			✓	✓	✓	142 lbs.	7356	7261	
C-57	57			✓	✓	✓	142 lbs.	7501	7401	

* Only 6, 7 & 9kW models can be field converted to single phase (units are shipped 3-phase open delta). Larger branch circuit required than for balanced 3-phase of equal kW. (Balanced 3-phase available in 4-6 & 9kW models, consult factory.) 208 and 240 volt only.

▼ 480V available in single phase only.

Contact factory if Balanced 3 Ph is required.

All Compact Electric Booster Models Feature:

Voltage: 208, 240 and 480.

Dimensions: Models C-4 through C-18: 13"W x 20 3/4"D x 19 3/4"H. Add 5/4" to depth for temperature/pressure relief valve. Height includes legs.

Models C-24 through C-57: 18"W x 24"D x 18"H. Add 6 1/2" to depth for temperature/pressure relief valve. Height includes legs.

Models Shipped with: Castone® tank, low-water cut-off (LWCO), temperature/pressure relief valve, pressure reducing valve, two temperature/pressure gauges, 6" black plastic non-adjustable legs, indicator light and On/Off switch.

Compact Booster Water Heaters are not recommended for shipment via FED-EX GROUND or United Parcel Service.

NOTE: Pages 236-238 for sizing information.

NOTE: Consult page 239 for proper breaker size. Verify amperage load for Booster Heaters 24kW through 57kW in single phase. Because of excessively high amps and since these units are NOT field convertible to any other voltage or phase, written confirmation is required before processing can begin.

OPTIONS AND ACCESSORIES – PAGE 231

LOW-TEMP DISHWASHERS – SEE LOW-TEMP SIZING DATA ON PAGE 235

WATER QUALITY REQUIREMENTS – PAGE 248

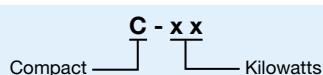



C-27 with accessory slide brackets

Quick-Ship

OPTIONS (available at time of purchase only) (not available on Quick-Ship)

SSBB	Stainless Steel Body and Base	No Charge
C-SECURITY	Security Package (Torx® Screws and Control Cover)	\$204

ACCESSORIES (available for purchase at any time)

✓ QSFLOORMOUNT	Additional Stainless Steel Floor Mounting Leg Assembly	\$374
✓ QSWATERTREAT	Blended Phosphate Injection System – not for potable water use (page 234 for illustration)	966
✓ QSSHOCK	Shock Absorber to reduce water hammer	138
✓ QSBPRV	Back Pressure Relief Valve	215
✓ QSPRVB	Additional Brass Pressure Reducing Valve with Bypass	211
✓ QSSSA-LEGS	Additional Stainless Steel Adjustable Legs (6"-7")	240
✓ QSBOSTERBRKT	Additional Slide Brackets	84

NOTE: 6" plastic adjustable legs (6"-7") standard. Description of accessories is shown on page 234.

WATER TEMPERATURE RECOVERY TABLE

Compact Model	40°F Rise	70°F Rise	Compact Model	40°F Rise	70°F Rise
C-4	40 gph	23 gph	C-18	181 gph	103 gph
C-5	50 gph	29 gph	C-24	241 gph	138 gph
C-6	60 gph	34 gph	C-27	271 gph	155 gph
C-7	70 gph	40 gph	C-30	301 gph	172 gph
C-9	90 gph	52 gph	C-36	361 gph	206 gph
C-12	120 gph	69 gph	C-39	391 gph	224 gph
C-13	135 gph	77 gph	C-45	452 gph	258 gph
C-15	151 gph	86 gph	C-54	542 gph	310 gph
C-17	173 gph	99 gph	C-57	573 gph	326 gph

NOTE: gph is "gallons per hour."



July 1, 2022

Imperial Electric Booster Water Heaters

Imperial Booster Water Heaters combine quality construction and rugged dependability to provide up to 573 gph of 180°F sanitizing rinse water. Models include stainless steel front panel, silver gray hammertone body, black base, standard 6" legs, Castone® lined tank and have a 16-gallon capacity.

- All models include a Castone® lined tank with a 10-year limited warranty
- Features temperature/pressure relief valve, two temperature gauges, a high-temperature limit control, pilot indicator light, On/Off switch and a low-water cut-off (LWCO) to prevent element burnout due to low water conditions
- Built-in heat trap and fiberglass insulation minimizes heat loss
- Stainless steel front panel and powdercoated silver-gray hammertone body is standard on all Imperial models



S-54

NOTE: Single phase is uncommon in heaters 24kW and larger and are NOT returnable.

Quick-Ship Model pages 241-247

IMPERIAL ELECTRIC BOOSTER WATER HEATERS

Model*	kW	Voltage			Ship Weight	List Prices	
		208V Single Ph	240V Single Ph	480V Three Ph		208 or 240V	480V
Small							
S-6	6				200 lbs.	\$5551	\$5551
S-7	7				200 lbs.	5631	5631
S-9	9				200 lbs.	5666	5666
S-12	12			✓	200 lbs.	5986	5986
S-13	13.5				200 lbs.	5996	5996
S-15	15			✓	200 lbs.	6041	6041
S-17	17.25	—	—		200 lbs.	6076	—
S-18	18			—	200 lbs.	6116	6116
Large							
S-24	24				214 lbs.	\$6991	\$6991
S-27	27				214 lbs.	7041	7041
S-30	30				214 lbs.	7141	7141
S-36	36			✓	214 lbs.	7651	7616
S-39	39				214 lbs.	7746	7706
S-40	40.5	—	—		224 lbs.	8001	7956
S-45	45			✓	224 lbs.	8126	8076
S-54	54			✓	224 lbs.	8146	8091
S-57	57			—	224 lbs.	8291	8231

* Only 6, 7 & 9kW models can be field converted to single phase (units are shipped 3-phase open delta). Larger branch circuit required than for balanced 3-phase of equal kW. (Balanced 3-phase available in 6 & 9kW models, consult factory.) 208 and 240V only.

All Imperial Electric Booster Models Feature:

Voltage: 208, 240 and 480.

Dimensions: 23¾"W x 22¾"D x 31½"H. Add 5" to width for temperature/pressure relief valve. Height includes legs.

Models Shipped with: Castone® tank, low-water cut-off (LWCO), temperature/pressure relief valve, pressure reducing valve, two temperature/pressure gauges, indicator light and On/Off switch.

NOTE: Pages 236-238 for sizing information.

NOTE: Consult page 239 for proper breaker size. Verify amperage load for Booster Heaters 24kW through 57kW in single phase. Because of excessively high amps and since these units are NOT field convertible to any other voltage or phase, written confirmation is required before processing can begin.

OPTIONS AND ACCESSORIES – PAGE 233

LOW-TEMP DISHWASHERS – SEE LOW-TEMP SIZING DATA ON PAGE 235

WATER QUALITY REQUIREMENTS — PAGE 248

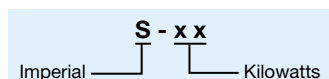



S-57 with optional Stainless Steel body and base, and accessory Stainless Steel legs

Quick-Ship

OPTIONS (available at time of purchase only) (not available on Quick-Ship)

SSBB	Stainless Steel Body and Base	No Charge
S-SECURITY	Security Package (Torx® Screws and Control Cover)	\$204

ACCESSORIES (available for purchase at any time)

	QSFLOORMOUNT	Additional Stainless Steel Floor Mounting Leg Assembly	\$374
	QSWATERTREAT	Blended Phosphate Injection System – not for potable water use (page 234 for illustration)	966
	QSSHOCK	Shock Absorber to reduce water hammer	138
	QSBPRV	Back Pressure Relief Valve	215
	QSPRVB	Additional Brass Pressure Reducing Valve with Bypass	211
	QSSSA-LEGS	Additional Stainless Steel Adjustable Legs (6"-7")	240

NOTE: 6" plastic adjustable legs (6"-7") standard.
Description of accessories is shown on page 234. Only leg mounting is available.

WATER TEMPERATURE RECOVERY TABLE

Imperial Model	40°F Rise	70°F Rise	Imperial Model	40°F Rise	70°F Rise
S-6	60 gph	34 gph	S-24	241 gph	138 gph
S-7	70 gph	40 gph	S-27	271 gph	155 gph
S-9	90 gph	52 gph	S-30	301 gph	172 gph
S-12	120 gph	69 gph	S-36	361 gph	206 gph
S-13	135 gph	77 gph	S-39	391 gph	224 gph
S-15	151 gph	86 gph	S-40	407 gph	232 gph
S-17	173 gph	99 gph	S-45	452 gph	258 gph
S-18	181 gph	103 gph	S-54	542 gph	310 gph
			S-57	573 gph	326 gph

NOTE: gph is "gallons per hour."



Booster Installation

SINGLE BOOSTER INSTALLATION

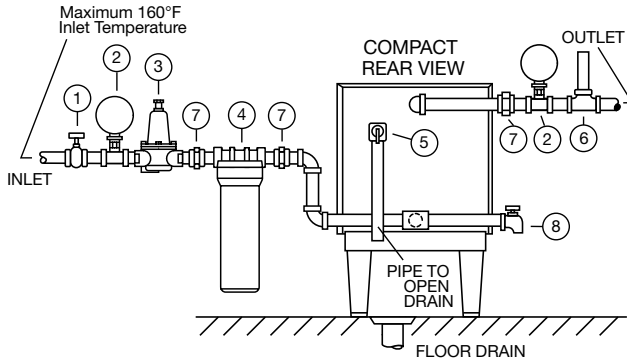

DUAL BOOSTER INSTALLATION

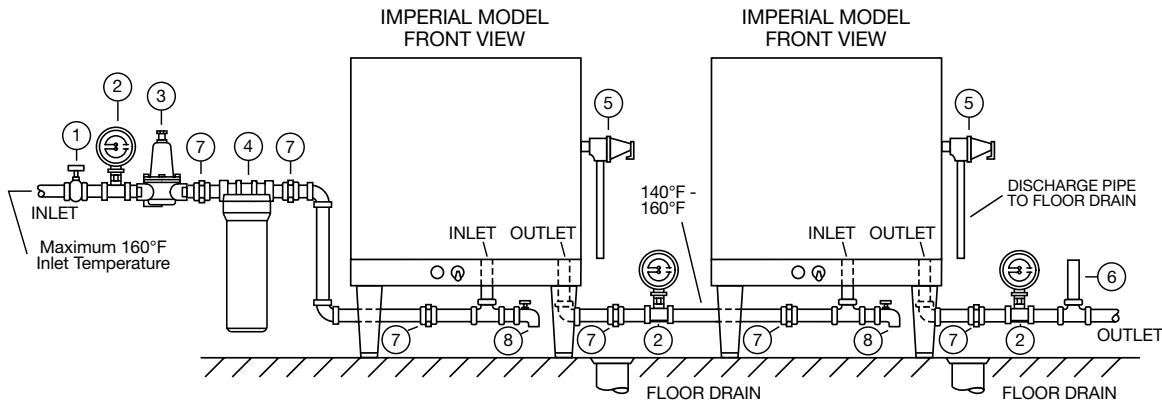

- ① 3/4" Gate or Ball Valve* ② Temperature/Pressure Gauge ③ Pressure Reducing Valve with By-Pass ④ Blended Phosphate Water Treatment System
⑤ Relief Valve (must have discharge pipe to floor drain) ⑥ Shock Absorber ⑦ Union* ⑧ Drain Pipe Valve* *Supplied by installer

CONSULT LOCAL CODES

NOTE: The differential temperature between outlet and inlet temperatures should never be less than 20°F.

NOTE: Thermostat calibration, or adjustment, must be performed at time of installation and is excluded from warranty coverage. Thermostat adjustments for Low-Temp applications are the responsibility of the installer.

BOOSTER WATER HEATER ACCESSORIES

Back Pressure Relief Valve –

This valve relieves pressure when unit is heating, on models that a check valve is required on the supply line. To be plumbed over an open site drain.



Bronze Pressure Reducing Valve –

This valve provides reduced corrosion and lead-free compliance. This adjusts water flow pressure to 20 psi.



Stainless Steel Adjustable Legs – Adjustable from 6" to 7". Clean appearance and heavy-duty for long wear.



Floor Mounting Hardware – Adjustable from 6" to 7". Corrosion-resistant stainless steel legs for deck mounting.



Blended Phosphate Water Treatment System –

Standard and required with Powermite® units. Minimizes scale formation and increases unit efficiency. Recommended for Electric Boosters. (Not for potable water use.)



Shock Absorber – Recommended between the booster and the dishwasher to prevent water hammer. Standard with Powermite® gas boosters.

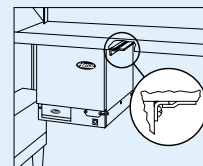

Slide Bracket – For mounting the booster heater under a dishwasher (available on small and large Compact models only).



Water Heater Data

PLUMBING DATA

Dielectric couplings should be used in connecting dissimilar metals, such as galvanized to copper, to prevent electrolysis.

All Hatco Booster Water Heaters require 3/4" piping.

A check valve should not be installed in the supply line to the booster heater.

All shut-off valves must be gate or ball valves – not globe valves.

BOOSTER HEATER SIZING FORMULA

$$\left(\frac{\text{GPH} \times \text{°F Temp. Rise}}{400} = \text{kW} \right)$$

NOTE: GPH is gallons per hour.

SEE BOOSTER HEATER SIZING CHART, PAGES 236-238.

ELECTRICAL FORMULAS

$$\text{Watts} = \text{Amps} \times \text{Volts} \quad \text{1-phase}$$

$$\frac{\text{Watts} \times .86}{\text{Volts}} = \text{Amps} \quad \text{3-phase (open delta)}$$

$$\frac{\text{Watts}}{\text{Volts} \times 1.73} = \text{Amps} \quad \text{3-phase (balanced delta)}$$

NOTE: When primary temperatures are less than 85°F consult factory for suitable booster heater.

WATER TEMPERATURE RECOVERY TABLE IN GPH °F RISE

kW	30°	40°	50°	60°	70°	80°	90°	100°
4	54	40	32	27	23	20	18	16
5	67	50	40	33	29	25	22	20
6	80	60	48	40	34	30	27	24
7	94	70	56	47	40	35	31	28
9	120	90	72	60	52	45	40	36
9.9	132	99	79	66	57	50	44	40
10.5	140	105	84	70	60	53	47	42
11.4	153	114	92	76	65	57	51	46
12	161	120	96	80	69	60	54	48
13.5	181	135	108	90	77	68	60	54
15	201	151	120	100	86	75	67	60
17.25	231	173	139	115	99	87	77	69
18	241	181	145	120	103	90	80	72
24	321	241	193	161	138	120	107	96
27	361	271	217	181	155	135	120	108
30	401	301	241	201	172	151	134	120
36	482	361	289	241	206	181	161	145
39	522	391	313	261	224	196	174	157
40.5	542	407	325	271	232	203	181	163
45	602	452	361	301	258	226	201	181
54	723	542	434	361	310	271	241	217
57	763	573	458	381	326	286	254	229

Sizing Chart For Low-Temp Dishmachines

BOOSTERS RATED AT 30°F RISE

Dishwasher Model Number	Electric Compact Booster	Electric Imperial Booster	Dishwasher Model Number	Electric Compact Booster	Electric Imperial Booster
AMERICAN DISH SERVICE			CHAMPION		
AH, AH-3D, AH-3D-S, AHC, AHC-3D, AHC-3D-S, ET-A, T-AF, ET-AH, ET-A-M, ET-AH-M, ET-A-3, ET-AH-3, L-90-3D, L-90-3D-K, L-90-3D-K-S, L-90-3D-S, L-90-3DC, L-90-3DC-K, L-90-3DC-K-S, L-90-3DC-S, L-90-3DW, L-90-3DW-K, L-90-3DW-K-S, L-90-3DW-S, L-90-3DWC, L-90-3DWC-K, L-90-3DWC-K-S, L-90-3DWC-S, WH, WHC	C-4	S-6	ULD, ULF	C-6	S-6
A-3D, A-3D-S, A, AC, AC-3D, AC-3D-S, AH-B, ET-AF-3, ET-AF-M, HT-25, L-60-3D, L-60-3D-K, L-60-3D-K-S, L-60-3D-S, L-60-3DC, L-60-3DC-K, L-60-3DC-K-S, L-60-3DC-S, L-60-3DW, L-60-3DW-K, L-60-3DW-K-S, L-60-3DW-S, L-60-3DWC, L-60-3DWC-K, L-60-3DWC-K-S, L-60-3DWC-S, L-72-3D, L-72-3D-K, L-72-3D-K-S, L-72-3D-S, L-72-3DC, L-72-3DC-K, L-72-3DC-K-S, L-72-3DC-S, L-72-3DW, L-72-3DW-K, L-72-3DW-K-S, L-72-3DW-S, L-72-3DWC, L-72-3DWC-K, L-72-3DWC-K-S, L-72-3DWC-S, W, WC	C-5	S-6	DLF	C-13	S-13
A-B, AD-25, SS-25, 5-AH, 5-AHS	C-6	S-6	KL44, KL66	C-36	S-36
AF, AF-3D, AF-3D-S, AF-B, AFC, AFC-3D, AFC-3D-S, AFW, AFWC, 5, 5-S	C-7	S-7	GMA DISHMACHINES		
ADC-44, ADC-66, 5-AG, 5-AGS, 5-CD-LF, 5-CD-RF	C-9	S-9	A-1, AH-1, C-1, VAC-1, A-3, AH-3, C-3, L-1C, VAC-3, VAC-4, VAC-5, L-1X	C-4	S-6
BLAKESLEE			A-2, AH-1, AH-2, AH-3, B-3, C-1, C-2, C-3, EVA-1, EVA-2, EVA-3, EVA-4, EVA-5, VAC-2	C-6	S-6
U21-C	C-4	S-6	B-1	C-7	S-7
D-8-LT	C-6	S-6	B-2	C-9	S-9
DD-8-LT, R-CC64-LT, R-EE-LT	C-12	S-12	CMA-44L with tank heater, CMA-66L	C-24	S-24
Series XF-EE-LT, XF-PEE-LT, XF-LL-LT, XF-PLL-LT, XF-MM-LT, XF-PMM-LT, XF-EEE-LT, XF-LLL-LT, XF-MMM-LT	C-13	S-13	CVA-1, CVA-2, CVA-3, CVA-4	C-6	S-6
Series R-L-LT, R-PL-LT, R-M-LT, R-PM-LT, F-L-LT, F-PL-LT, F-M-LT, F-PM-LT (single tank)	C-36	S-36	CVA-5	C-7	S-7
Series "R" & "F"-CC-LT, -EE-LT, -LL-LT, -MM-LT, -LLL-LT, -MMM-LT, -PCC-LT, -PEE-LT, -PLL-LT, -PMM-LT (multi-tank)	C-24	S-24	HOBART		
Series XF-L-LT, XF-PL-LT, XF-M-LT, XF-PM-LT (single tank)	C-54	S-54	LX-18C, LX-30C, LX-40C, WM-5C, SR24C	C-4	S-6
Series XF-PEE-LT, XF-PLL-LT, XF-PMM-LT, XF-EEE-LT, XF-LLL-LT, XF-MMM-LT (multi-tank)	C-36	S-36	LT-1	C-6	S-6
FA (Flight-A-Round) and RA (Rack-A-Round) use comparable "F" listing.			AM-14, AM-14C	C-7	S-7
			C44A, CRS66A, CPW80A	C-27	S-27
			FT-800	C-30	S-30
			JACKSON		
			Conservor 24LT, 200LT, ES1000 (Ecolab/Jackson)	C-4	S-6
			Conservor 1, Conservor XL, ES2000 (Ecolab/Jackson)	C-9	S-9
			Conservor 2, Conservor XL2, ES4000 (Ecolab/Jackson)	C-15	S-15
			AJ-44, AJ-66, AJ-80	C-18	S-18
			KNIGHT EQUIPMENT LTD.		
			KLE-112-HL	C-5	S-6
			KLE-117i, KLE-117c, KLE-175GT, KLE-175GTM	C-9	S-9
			KLE-235d	C-13	S-13
			KLE-175GT Corner, KLE-175GTM Corner	C-12	S-12

Low-Temp Sizing Data

Chemical low-temp dishwashers are most effective when supplied with a 140°F hot water supply. Sometimes this water temperature is not available due to undersized primary water heaters or local safety codes. Hatco can provide a pre-heater for chemical low-temp dishwashers to provide an adequate supply of 140°F hot water for proper operation.

NOTE: When ordering a heater for use with a chemical low-temp dishwasher, thermostat adjustments for low-temp applications are the responsibility of the installer.

To properly size a Hatco heater for low-temp use:

- Determine the required temperature rise by subtracting the available hot water supply temperature from 140°F. This should be a minimum of 30°F.
- Determine the water usage by consulting the dishwasher data plate, literature, or NSF listing. This should be shown as gallons per hour (GPH).
- Use the Hatco formula for sizing or the sizing chart on this page to determine the required kW and select the appropriate Hatco model.



July 1, 2022

Booster Heater Sizing Chart

Dishwasher Model Number	Electric Compact Booster Temperature Rise		Electric Imperial Booster Temperature Rise		Gas Powermite® Booster [▲] Temperature Rise	
	40°F	70°F	40°F	70°F	40°F	70°F
ADAMATION						
CSL-1390, CA-2, CA-3, CA-4, SLAP 44	C-39	(2)C-36	S-39	(2)S-36	PMG-200	(2)PMG-200
CA, CA-1	C-54	(2)C-45	S-54	(2)S-45	PMG-200	(2)PMG-200
ALVEY						
FLC-10, SL-2S			S-6	S-9		
FLC-12, CL-1, CL-1Turntable, SA-5A			S-7	S-12		
FL-2S			S-9	S-13		
KS-70, KS70M SB			S-9	S-15		
SL-2D			S-13	S-18		
FLC-36			S-15	S-27		
KS-88-C			S-18	S-30		
KS-70-N, KS-88-N			S-39	(2)S-40		
AMERICAN DISH SERVICE						
AF-ES, AFC-ES	C-4	C-7	S-4	S-7		
HT-25	C-7	C-12	S-7	S-12		
ADC-44, ADC-66	C-12	C-24	S-12	S-24		PMG-100
BLAKESLEE						
UC-21A, UC-21B	C-4	C-4	S-6	S-6	PMG-100	PMG-100
UC-21	C-6	C-12	S-6	S-12	PMG-100	PMG-100
D-8	C-9	C-13	S-9	S-13	PMG-100	PMG-100
D-9	C-12	C-17	S-12	S-17	PMG-100	PMG-100
Series "R" & "F" -CC, -EE, -LL, -MM, -LLL, -MMM, -PCC, -PEE, -PLL, -PMM (multi-tank) with suffix "LC"	C-13	C-24	S-13	S-24	PMG-200	PMG-200/100
Series XF-EE, XF-LL	C-17	C-30	S-17	S-30	PMG-100	PMG-200
Series XF-LL, XF-PLL, XF-MM, XF-PMM, XF-EEE, XF-LLL, XF-MMM (Multi-tank) with suffix "LC"	C-17	C-30	S-17	S-30	PMG-200	PMG-200/100
DD-8	C-18	C-30	S-18	S-30	PMG-100	PMG-200
Series F-E, FA-EE, FA-PEE, FA-LL, FA-PLL, FA-MM, FA-PMM, F-EEE, FA-EEE, FA-LLL, FA-MMM, F-PE	C-30	C-54	S-30	S-54	PMG-200	PMG-200/100
Series R-L, R-PL, R-M, R-PM, F-L, F-PL, F-M, F-PM (single tank)	C-36	C-54	S-36	S-54	PMG-200	(2)PMG-200
Series XF-L, XF-PL, XF-M, XF-PM (single tank)	(2)C-36		(2)S-36			
Series R-E, R-PE, XF-PEE, XF-PLL, XF-PMM, XF-EEE, XF-LLL, XF-MMM (multi-tank) FA (Flight-A-Round) and RA (Rack-A-Round) use comparable "F" listing.	C-45	(2)C-30	S-45	(2)S-30	PMG-200	(2)PMG-200
XF-EE, XF-EE-LT (with LT suffix)	C-17	C-36	S-17	S-36	PMG-100	PMG-200
CHAMPION						
U-H1, UH-200, UH-200B, U-HB	C-4	C-6	S-6	S-6	PMG-100	PMG-100
UL-100, UH-100B, UH-170B, UH-200B, DH-2000	C-6	C-9	S-6	S-9	PMG-100	PMG-100
UL-150	C-4	C-7	S-6	S-7	PMG-100	PMG-100
UH-150, UH-150B, UH-100, UH-100B, DHB-VS	C-5	C-9	S-6	S-9	PMG-100	PMG-100
D-H1, D-HB, D-H1T, D-HBT	C-9	C-13	S-9	S-13	PMG-100	PMG-100
44 DRWS, 66 DRPWWS, 80 DRHDPWWS, 70 DRFFPWWS	C-9	C-13	S-9	S-13	PMG-100	PMG-100
PP-28	C-27	C-45	S-27	S-45	PMG-100	PMG-200
D-H1C, D-H1TC	C-9	C-18	S-9	S-18	PMG-100	PMG-100
DL-1000, DH-1000, DHB-VS	C-6	C-12	S-6	S-12	PMG-100	PMG-100
44DR, 66DRPW, 80DRHDFW, 70DRFFPW, 54DR, 76DRPW, 80DRFFPW, 90DRHDPW	C-12	C-24	S-12	S-24	PMG-100	PMG-100
44-WS, 66 WSPW, 66-WS, 64, 70WSFFPW, 80WSHDPW, 90FFPW, 100HDPW, 86 PW, 84, 106 PW, 120 HDPW, 110 FFPW	C-15	C-24	S-15	S-24	PMG-100	PMG-100
UC-CW6-WS	C-24	C-36	S-24	S-36	PMG-100	PMG-200
US-CW8-WS	C-24	C-39	S-24	S-39	PMG-100	PMG-200
44, 66 PW, 70FFPW, 80HDPW	C-27	C-54	S-27	S-54	PMG-100	PMG-200
54, 76PW, 80FFPW, 90HDPW,	C-24	C-45	S-24	S-45	PMG-100	PMG-200
40-KB, 40-KB-2-2, 40-KFWB, 40-KPRB, 40-KPRB-2-2, 40KPRB-2-3, 44LT, 60-KB, 60-KB-2-2, 60-KFWB, 60-KFWB-2-2, 60-KPRB, 60-KPRB-2-3, 64KB, 64-KB Corner, 64-KPRB, 64-KPRB Corner, 64 Modular, 66LT, 86 Modular	C-30	C-54	S-30	S-54	PMG-200	PMG-200/100
44-KB, 44-KB Corner, 44-KPRB, 44-KPRB Corner, 54-KB, 54-KB Corner, 54-KPRB, 54-KPRB Corner, 44 Modular, 66 PW Modular, UC** Series 6' Center, UC-C4	C-36	C-57	S-36	S-57	PMG-200	PMG-200/100
UC-CW4	C-36	(2)C-36	S-36	(2)S-36	PMG-200	PMG-200/100
UC-C	C-45	(2)C-36	S-45	(2)S-36	PMG-200	PMG-200/100
UC**CW Series 6' Center	C-45	(2)C-39	S-45	(2)S-39	PMG-200	(2)PMG-200
W-6-WS, W6	C-45	(2)C-45	S-45	(2)S-40	PMG-200	(2)PMG-200

[▲] Powermite installations above 2,000 ft. will reduce the above capacities and may require change of pressure and/or orifices in certain models at time of install to meet IAS safety compliance. These modifications are the responsibility of the installer. Consult "Installation and Operating Manual" for sizing adjustments and orifice changes.

Booster Heater Sizing Chart

Dishwasher Model Number	Electric Compact Booster Temperature Rise		Electric Imperial Booster Temperature Rise		Gas Powermite® Booster [▲] Temperature Rise	
	40°F	70°F	40°F	70°F	40°F	70°F
CMA DISHMACHINES						
AH, C, B [⊙]	C-9					
CMA-180	C-5	C-9	S-5	S-9		
CMA-180T	C-9	C-13	S-9	S-13		
CMA-44/66	C-24	C-36	S-24	S-36	PMG-100	PMG-200
CMA-44H with tank heater, CMA-66H	C-36	C-45	S-36	S-45	PMG-100	PMG-200
EAH/EC [⊙] , GLX/L1X/L1X16/L1C	C-4					
EST [⊙]	C-5					
EST-44/66	C-12	C-24	S-12	S-24	PMG-100	PMG-100
HOBART						
AM-15F	C-4	C-6	S-6	S-9	PMG-100	PMG-100
LXiC, LXiGC, LX-18C, LX-30C, LX-40C, AM-15F	C-4	C-7	S-6	S-6	PMG-100	PMG-100
LX-30, SR24, SR24H	C-4	C-7	S-6	S-7	PMG-100	PMG-100
LX-18, AM-14F, AM-15, AM-15T	C-5	C-9	S-6	S-9	PMG-100	PMG-100
WM-5C	C-6	C-9	S-6	S-9		PMG-100
WM-5 (Without sump heater)	C-7	C-12	S-7	S-12		
AM-14T, AM-14TC	C-7	C-12	S-7	S-12	PMG-100	PMG-100
AM-14, AM-14C	C-9	C-17 or C-18	S-9	S-17 or S-18	PMG-100	PMG-100
AM-12, AM-12C [*]	C-9	C-12	S-9	S-12	PMG-100	PMG-100
UW-50			S-15	S-24		
^{OR} Opti-RinSe C44A, CRS-66A, CCS-66A, CPW-80A, C54A, CRS-76A, CCS-76A, CPW-90A, C64A, CRS-86A, CCS-86A, CPW-100A, C88A, CRS-110A, CCS-11-0A, CPW-124A	C-15	C-27	S-15	S-27	PMG-100	PMG-200
C-54A, CRS-76A, CPW-90A, CCS-76A	C-39	(2)C-36	S-39	(2)S-36	PMG-200	PMG-200/100
C-44A, CRS-66A, CCS-66A, CPW-80A, C-64A, CRS-86A, CCS-86A, CPW-100A	C-30	C-54	S-30	S-54	PMG-200	PMG-200/100
C-88A, CRS-110A, CPW-124A, CCS-110A	C-36	C-54	S-36	S-54	PMG-200	PMG-200/100
Opti-RinSe C44AW, CRS-66AW, CCS-66AW, CPW-80AW	C-9	C-15	S-9	S-15	PMG-100	PMG-100
^{OR} C-44AW, CRS-66AW, CPW-80AW, CCS-66AW	C-12	C-24	S-12	S-24	PMG-100	PMG-100
C-44, CRS-66, CPW-80	C-36	C-54	S-36	S-54	PMG-200	PMG-200/100
CL44e, CL66e	C-13	C-24	S-13	S-24	PMG-100	PMG-200
CLPS66e	C-15	C-30	S-15	S-30	PMG-100	PMG-200
C-54, CRS-76, CPW-90	C-54	(2)C-39	S-54	(2)S-39	PMG-200/100	(2)PMG-200
C-64W, CRS-86W, CPW-100W, C-88W, CRS-110W, CPW-124W, CCS-86W	C-24	C-36	S-24	S-36	PMG-100	PMG-200
C-64, CRS-86, CPW-100	C-45	(2)C-36	S-45	(2)S-36	PMG-200	PMG-200/100
FT800W, FT-900W	C-24	C-39	S-24	S-39	PMG-200	PMG-200
FT-600, FT-700	C-54	(2)C-39	S-54	(2)S-39	PMG-200/100	(2)PMG-200
FT800	C-39	(2)C-39	S-39	(2)S-39	PMG-200	(2)PMG-200
FT900	C-36	C-57	S-36	S-57	PMG-200	PMG-200/100
FT800S, FT-900S	C-39	(2)C-36	S-39	(2)S-36	PMG-200	PMG-200/100
UTW-28, UTW-28C			S-18	S-36		
FRC and FR (Fast Rack Series) use comparable "C" line listing.						
INSINGER						
GS 302, GS-14	C-4	C-4	S-6	S-6	PMG-100	PMG-100
45SA-5	C-9	C-18	S-9	S-18	PMG-100	PMG-100
Commander 18-5 Series, CS-5, CS-5C, CS-5CH, CS-5H, Ensign 40-2	C-6	C-12	S-6	S-12	PMG-100	PMG-100
Commander 18-6 Series, 18-6H	C-6	C-12	S-6	S-12	PMG-100	PMG-100
Commander 18-6, 18-6H (Built-In)	ABB-13.5	ABB-13.5				
Admiral 44-4, 66-4, Speeder 64, 86-3, Clipper (all)	C-15	C-27	S-15	S-27	PMG-100	PMG-200
Admiral 44-4, 66-4 (Built-In)	ABB-15-8	ABB-27-8				
135-20, 185-20, 250-20, 60-20, 85-20, Gallymaster & Modular	C-54		S-54			PMG-200
Century (all)	C-24	C-45	S-24	S-45	PMG-100	PMG-200
Trac 878	C-24	C-36	S-24	S-36	PMG-100	PMG-200
Super 106-2, Trac 321, Trac 321-2/RPW	C-27	C-45	S-27	S-45	PMG-100	PMG-200
Defender Flight Machine	C-36	C-54	S-36	S-54	PMG-200	(2)PMG-200
Master RC 3-tank Flight Machine	C-15	C-27	S-15	S-27	PMG-200	(2)PMG-200
Master RC 4-tank Flight Machine	C-36	C-57	S-36	S-57		
CA-3 [⊙]			S-9	S-24	PMG-200	
DA-3 [⊙]			(2)S-9	(2)S-24		
For outdated models, consult factory for correct booster.						

* Model AM-12 with serial no. 12-067-357 or below and model AM-12C with serial no. 12-067-537 or below require slightly larger booster than listed.

[⊙] All cycles

^{OR}C Models with serial no. 85-1041605 or greater use Opti-RinSe.

■ Shaded area indicates older models prior to Opti-RinSe.

[▲] Powermite installations above 2,000 ft. will reduce the above capacities and may require change of pressure and/or orifices in certain models at time of install to meet IAS safety compliance. These modifications are the responsibility of the installer. Consult "Installation and Operating Manual" for sizing adjustments and orifice changes.

[⊙] Consult factory - special plumbing may apply.



July 1, 2022

Booster Heater Sizing Chart

Dishwasher Model Number	Electric Compact Booster Temperature Rise		Electric Imperial Booster Temperature Rise		Gas Powermite® Booster [▲] Temperature Rise	
	40°F	70°F	40°F	70°F	40°F	70°F
JACKSON						
JP-24, JP-24B, JP-24F, JP-24BF	C-4	C-6	S-6	S-6	PMG-100	PMG-100
24B Series		C-4		S-6		PMG-100
10AB, 10APRB		C-5		S-6		PMG-100
44CE, 66 CERPW	C-30	C-54	S-30	S-54	PMG-200	
54CE, 76 CERPW	C-36	(2)C-30	S-36	(2)S-30	PMG-200	
64CE, 86 CERPW	C-27	C-39	S-27	S-39	PMG-200	
100	C-12	C-24	S-12	S-24	PMG-100	
100B, 100PRB, 150B, 150PRB		C-9		S-9		
150	C-12	C-18	S-12	S-18		PMG-100
200	C-7	C-12	S-7	S-12	PMG-100	PMG-100
200B		C-6		S-6		PMG-100
Tempstar GPX						PMG-100
Tempstar, Tempstar SDS, Tempstar HH	C-6	C-12	S-6	S-12	PMG-100	PMG-100
TS-44, TS-66	C-24	C-36	S-24	S-36	PMG-100	PMG-200
AJ-44, AJ-66, AJ-80, WH-44, ES-4400, ES-6600 (ECOLAB/JACKSON)	C-24	C-45	S-24	S-45	PMG-100	PMG-200
AJ-54, AJ-76, AJ-90	C-30	C-54	S-30	S-54	PMG-200	PMG-200/100
AJ-64, AJ-86, AJ-100	C-24	C-39	S-24	S-39	PMG-100	PMG-200
* Model #44CE w/SN1999 or below requires larger booster than listed.						
KNIGHT EQUIPMENT LTD.						
KLE-112-HL	C-7	C-12	S-7	S-12	PMG-100	PMG-100
MEIKO						
K-44, K-66, K-80	C-24	C-36	S-24	S-36	PMG-100	PMG-200
K-54, K-76, K-90, K-64, K-86, K-100	C-24	C-45	S-24	S-45	PMG-100	PMG-200
METALWASH/INTEDGE						
FW4	C-12	C-18	S-12	S-18	PMG-100	PMG-100
RS-30A, RS-28L			S-15	S-24		
RT-74, RT-60, RT-42B, RT-42BC			S-27	S-40		
RS-2R			S-30	S-45		
STERO						
ER-44, ER-44-10, ER-66S, ER-76S, ER-76SC	C-15	C-24	S-15	S-24	PMG-100	PMG-100
ER-64, ER-86S, ER-94S, ER-94SC	C-15	C-24	S-15	S-24	PMG-100	PMG-100
SCT-44-10-LW, SCT-44-LW, SCT-66S-LW, SCT-76S-LW, SCT-76SC-LW, SCT-90S-LW	C-15	C-24	S-15	S-24	PMG-100	PMG-100
SC-1-2-4-LW, SC-1-6-4-LW, SC-2-4-LW, SC-5-2-4-LW, SC-5-6-4-LW, SC-6-4-LW	C-15	C-24	S-15	S-24	PMG-100	PMG-200
SCT-64, SCT-86S, SCT-94S, SCT-94SC	C-24	C-45	S-24	S-45	PMG-100	PMG-200
SCT-108S, SCT-108SC, SCT-76, SCT-94SM	C-30	C-54	S-30	S-54	PMG-200	PMG-200/100
SC-6-4, SCT-44, SCT-44-10, SCT-66S, SCT-76S, SCT-76SC, SCT-90S	C-36	C-54	S-36	S-54	PMG-200	PMG-200/100
SCT-120S, SCT-120SC, SCT-120SM, SCT-150SM	C-36	C-57	S-36	S-57	PMG-200	PMG-200/100
STW-110, SC-1-2-7-4, SC-1-6-3-4, SC-1-6-7-4, SC-2-7-4, SC-5-2-7-4, SC-5-6-3-4, SC-5-6-7-4, SC-6-3-4, SC-6-7-4	C-30	C-54	S-30	S-54	PMG-200	PMG-200/100
SC-1-2-4, SC-1-6-4, SC-2-4, SC-5-2-4, SC-5-6-4	C-36	(2)C-57	S-36	(2)S-57	PMG-200	(2)PMG-200
SCT-44-10-SC-1-3-4, SCT-44-10-3-4, SCT-44-SC-1-3-4, SCT-44-SC-3-4, SCT-54-SC-1-3-4, SCT-54-SC-3-4, SCT-76S-SC-3-4	C-36	C-54	S-36	S-54	PMG-200	(2)PMG-200
STPC (Four tank)	C-24	C-45	S-24	S-45	PMG-100	PMG-200
STPCW (Four tank)	C-27	C-45	S-27	S-45	PMG-100	PMG-200
STPC	C-30	C-54	S-27	S-54	PMG-200	PMG-200/100
STPCW	C-36	(2)C-30	S-36	(2)S-30	PMG-200	PMG-200/100
SD-2RA, SDRA, SDRA-PACK	C-12	C-18	S-12	S-18	PMG-100	PMG-100
U-31-A, U-31-AC			S-24	S-45	PMG-100	PMG-200
U-31-A2			(2)S-24	(2)S-45	PMG-200	(2)PMG-200
STBUW-1	C-45	(2)C-36	S-45	(2)S-36		
SC-2-3-4, SC-5-2-3-4	C-30	C-45	S-30	S-45	PMG-200	
SC20-1 (low temp.)	C-12		S-12		PMG-100	
SC20-2 (low temp.)	C-12	C-24	S-12	S-24		PMG-100
SC-2-8, SC-2-9, SC-1-2-8, SC-5-6-8, SC-6-8, SC-6-9, SC-1-6-8, SC-5-6-9, SC-5-2-9, SC-1-6-9, SC-5-2-8 (low temp.)	C-18	C-36	S-18	S-36	PMG-100	PMG-200

▲ Powermite installations above 2,000 ft. will reduce the above capacities and may require change of pressure and/or orifices in certain models at time of install to meet IAS safety compliance. These modifications are the responsibility of the installer. Consult "Installation and Operating Manual" for sizing adjustments and orifice changes.

This selector chart is based on 40°F and 70°F temperature rises, 20 psi flow pressure, and minimum rinse cycle timer setting in NSF listing.

All booster heaters are rated at 100% of the capacity of the dishwashers as recommended by the National Sanitation Foundation. Where make-up water for wash tank is provided from final rinse supply, chart recommendations are based upon this additional demand (not over 2 GPM) as required by NSF.

All sizings shown are that of the dishwasher manufacturers. Hatco Corporation is not responsible for incorrect sizing applications.

BOOSTER HEATER SIZING FORMULA

$$\left(\frac{\text{GPH} \times \text{°F Temp. Rise}}{400} = \text{KW} \right)$$

NOTE: GPH is gallons per hour.

Electrical Ratings For Hatco Water Heaters

Watts	Volts	Phase	Amps	Breaker or Fuse size
4kW	208	1	19	30
	240	1	17	30
	480	1	8	15
5kW	208	1	24	30
	240	1	21	30
	480	1	10	15
6kW	208	1	29	40
	208	3	25 [†]	40
	240	1	25	40
	240	3	22 [†]	30
	480	3	11 [†]	15
7kW	600	3	5.7	15
	208	1	34	50
	208	3	29 [†]	40
	240	1	29	40
	240	3	25 [†]	40
9kW	480	3	13 [†]	20
	600	3	6.7	15
	208	1	43	60
	208	3	38 [†]	50
	240	1	38	50
9.9kW	240	3	33 [†]	50
	480	3	16.3 [†]	30
	600	3	8.7	15
10.4kW	208	1	47.5	60
	208	3 (BAL.)	27.5	40
11.4kW	208	3 (BAL.)	28.8	40
	240	1	47.5	60
	240	3 (BAL.)	27.5	40
12kW	480	3 (BAL.)	13.7	20
	208	1	58	90
	208	3	33	50
	240	1	50	70
	240	3	29	40
13.5kW	480	3	14.5	20
	600	3	11.6	20
	208	1	65	90
	208	3	38	50
	240	1	56.3	90
15kW	240	3	33	50
	480	3	16.3	30
	600	3	13	20
	208	1	72	90
	208	3	41.7	60
17.25kW	240	1	62.5	90
	240	3	36.1	50
	480	3	18.1	30
	600	3	14.5	20
	208	3	47.9	60
18kW	208	1	86.5	125
	240	1	75	100
	240	3	43.4	60
	480	3	21.7	30
600	3	17	30	

† Open Delta (unbalanced load) amperage of high leg indicated.

USE COPPER WIRE ONLY

ELECTRICAL FORMULAS

Watts = Amps
Volts 1-phase

Watts x .86 = Amps
Volts 3-phase
(open delta)

Watts = Amps
Volts x 1.73 3-phase
(balanced delta)

Watts	Volts	Phase	Amps	Breaker or Fuse size
24kW	208	1	115.4	150
	208	3	66.7	90
	240	1	100	125
	240	3	57.8	90
	480	3	29.9	40
27kW	600	3	23.2	30
	208	1	129.8	175
	208	3	75	100
	240	1	112.5	150
	240	3	65	90
30kW	480	3	32.5	50
	600	3	26.1	40
	208	1	144	200
	208	3	83.3	125
	240	1	125	175
36kW	240	3	72.3	100
	480	3	36	50
	600	3	29	40
	208	1	173	225
	208	3	100	125
39kW	240	1	150	200
	240	3	86.7	125
	480	3	43.3	60
	600	3	34.8	50
	208	1	187.5	250
40.5kW	208	3	108	150
	240	1	163.5	225
	240	3	94	125
	480	3	47	60
	600	3	37.7	50
45kW	208	3	112.5	150
	240	3	97.5	125
	480	3	48.8	70
	600	3	39	50
	208	3	125	175
54kW	240	1	188	250
	240	3	108	150
	480	3	54	70
	600	3	43.5	60
	208	3	150	200
57kW	240	3	130	175
	480	3	65	90
	600	3	52.1	70
	208	3	158.4	200
	240	3	137.3	175
	480	3	68.6	90
	600	3	54.9	70

Food Pans And Trivets

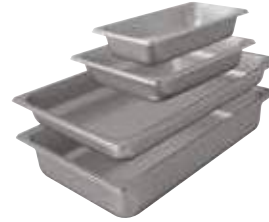

FOOD PANS

Model	Description	List Price
ALUM PAN	Half-Size Sheet Pan – 18"W x 13"D	\$ 35
18" SHEET PAN	Full-Size Sheet Pan – 18"W x 26"D	49
14" PIZZA PAN	Perforated Pizza Pan – 14" Diameter	38
16" PIZZA PAN	Perforated Pizza Pan – 16" Diameter	43
18" PIZZA PAN	Perforated Pizza Pan – 18" Diameter	45
ST PAN 1/3	Third-Size Stainless Steel Pan – 12 ³ / ₄ "W x 6 ⁷ / ₈ "D x 2 ¹ / ₂ "H	64
ST PAN 1/2	Half-Size Stainless Steel Pan – 12 ³ / ₄ "W x 10 ³ / ₈ "D x 2 ¹ / ₂ "H	74
ST PAN 2	Full-Size Stainless Steel Pan – 12 ³ / ₄ "W x 20 ³ / ₄ "D x 2 ¹ / ₂ "H	88
ST PAN 4	Full-Size Stainless Steel Pan – 12 ³ / ₄ "W x 20 ³ / ₄ "D x 4"H	110

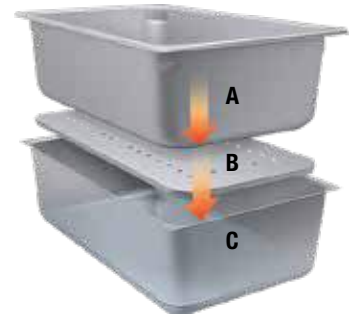

FOOD PANS AND TRIVETS

Model	Description	List Price
HDW-TRIVET	Custom Trivet raises food product 1/2" off bottom of Full-Size Pan - 17 ¹ / ₂ " x 9 ¹ / ₂ " x 1/2"	\$ 67
HDW-SPILL	Water/Spillage Pan - one per drawer (excludes HDW-1R2, -2R2)	291
HDW-SPLASH	Splash Baffle - one per drawer (excludes HDW-1R2)	61
HDW 6" PAN	Full-Size Stainless Steel Food Pan 12 ³ / ₄ "W x 20 ³ / ₄ "D x 6"H	120

Additional Humidity

- A. Stainless Steel Food Pan
- B. Splash Baffle
HDW-SPLASH Accessory
- C. Water/Spillage Pan (adds 1/4" of water)
HDW-SPILL Accessory

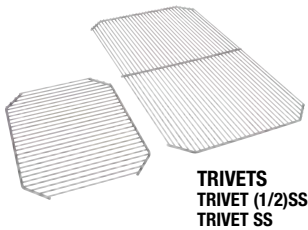

FOOD PANS AND TRIVETS

Model	Description	List Price
Wire Trivets Stainless –		
TRIVET (1/2)SS	Half-Size – 10 ³ / ₁₆ "W x 7 ⁵ / ₈ "D	\$119
TRIVET SS	Full-Size – 10 ³ / ₁₆ "W x 18"D	165

Stock Items For “Quick-Ship” Program



When you need equipment shipped sooner than our normal lead time, our “Quick-Ship” program offers our most popular equipment in various voltages ready for immediate shipment based on availability.

Your order will be shipped the same day if you place it before 12 noon Central Standard Time, or the next business day if ordered after 12 noon.

All orders are subject to credit approval.

Contact us at 1-800-4-HOT IDEAS (1-800-446-8433) between 7:00 A.M. and 5:00 P.M. Central Standard Time Monday through Friday. Consult Equipment Sales & Customer Service for available accessories.

ORDER PICKUP STATIONS & LOCKERS

Model	Item Number	Voltage/Phase 120/1	Voltage/Phase 208/1	Voltage/Phase 240/1	Description
Glo-Ray 2-Go™ Heated Shelf					
GRS2G-3920-5	GRS2G39205515	\$5983			5 heated shelves

ROUND HEATED WELLS

Model	Item Number	Voltage/Phase 120/1	Voltage/Phase 208/1	Voltage/Phase 240/1	Description
Freestanding					
RHW-1	RHW.00010	\$985			Freestanding Round Heated Well
RHW-2	RHW.00012		\$1524	\$1524	Freestanding Round Heated Wells
Built-In					
RHW-1B	RHW.00011	920			Built-In Round Heated Well

COUNTERTOP HEATED WELLS

Model	Item Number	Voltage/Phase 120/1	Description
Standard Watt			
HW-FUL	HW.00001	\$607	Full-size hold only
HW-43	HW.00002	761	4/3-size hold only
High Watt			
CHW-FUL	CHW.00001	690	Full-size cook & hold
CHW-43	CHW.00002	799	4/3-size cook & hold

REFRIGERATED DROP-IN WELLS

Model	Item Number	Voltage/Phase 120/1	Description
CWB-2	CWB2513	\$7583	Full-size insulated rectangular, 2-pan
CWB-3	CWB3513	8133	Full-size insulated rectangular, 3-pan
CWB-4	CWB4513	8717	Full-size insulated rectangular, 4-pan

DECORATIVE LAMPS

Model	Item Number	Voltage/Phase 120/1	Description
DL-500-RTR	DL500RTRBB-BK.1	\$ 878	Bold Black, with Black cord & track and coated bulb
DL-500-RTR	DL500RTRBRNBK.1	1069	Bright Nickel, with Black cord & track and coated bulb
DL-500-RTL	DL500RTLBB-BK.1	878	Bold Black, with Black cord & track and coated bulb
DL-500-RTL	DL500RTLBRNBK.1	1069	Bright Nickel, with Black cord & track and coated bulb
DL-775-RTR	DL775RTRBB-BK.1	917	Bold Black, with Black cord & track and coated bulb
DL-775-RTR	DL775RTRBRNBK.1	1108	Bright Nickel, with Black cord & track and coated bulb
DL-775-RTL	DL775RTLBB-BK.1	917	Bold Black, with Black cord & track and coated bulb
DL-775-RTL	DL775RTLBRNBK.1	1108	Bright Nickel, with Black cord & track and coated bulb

GLO-RITE® DISPLAY LIGHTS

Model	Item Number	Voltage/Phase 120/1	Description
HL-24	HL24120T	\$421	24" Display Light
HL-36	HL36120T	507	36" Display Light
HL-48	HL48120T	593	48" Display Light
HL-60	HL60120T	679	60" Display Light

ALUMINUM STRIP HEATERS WITH CONDUIT

Model	Item Number	Voltage/Phase 120/1	Voltage/Phase 208/1	Description
Standard Watt				
GRA-24	GRA24115T	\$342		With built-in toggle switch and conduit
GRA-36	GRA36115T	389		
GRA-48	GRA48115T	439		
GRA-60	GRA60115T	498		

**ALUMINUM STRIP HEATERS WITH CONDUIT**

Model	Item Number	Voltage/Phase		Description
		120/1	208/1	
High Watt				
GRAH-18	AH18115T	\$333		With built-in toggle switch and conduit
GRAH-24	AH24115T / AH24208T	350	\$350	With built-in toggle switch and conduit
GRAH-24	AH24115INF	397		With built-in infinite switch
GRAH-30	AH30120T	374		With built-in toggle switch and conduit
GRAH-36	AH36115T / AH36208T	397	397	With built-in toggle switch and conduit
GRAH-36	AH36115INF	444		With built-in infinite switch
GRAH-42	AH42120T	421		With built-in toggle switch and conduit
GRAH-48	AH48115T / AH48208T	447	447	With built-in toggle switch and conduit
GRAH-48	AH48115INF	494		With built-in infinite switch
GRAH-60	AH60115T / AH60208T	506	506	With built-in toggle switch and conduit
GRAH-72	AH72115T / AH72208T	627	627	With built-in toggle switch and conduit
High Watt with Lights				
GRAHL-24	GRAHL24115T	\$546		With built-in toggle switch and conduit
GRAHL-36	GRAHL36115T	667		
GRAHL-48	GRAHL48115T	794		

ALUMINUM STRIP HEATERS WITH S HOOKS, CHAINS AND CORD & PLUG ATTACHED

Model	Item Number	Voltage/Phase		Description
		120/1		
Standard Watt				
GRA-24	GRA24120TCCS	\$393		Toggle controlled with two S-hooks, two 6" chains and attached cord & plug
GRA-36	GRA36120TCCS	440		
GRA-48	GRA48120TCCS	490		
GRA-60	GRA60120TCCS	549		
High Watt				
GRAH-18	AH18120TCCS	\$384		Toggle controlled with two S-hooks, two 6" chains and attached cord & plug
GRAH-24	AH24120TCCS	401		
GRAH-30	AH30120TCCS	425		
GRAH-36	AH36120TCCS	448		
GRAH-42	AH42120TCCS	472		
GRAH-48	AH48120TCCS	498		
GRAH-60	AH60120TCCS	557		
GRAH-72*	AH72120TCCS.1	678		
High Watt				
GRAH-24	AH24120ICCS	\$448		Infinite controlled with two S-hooks, two 6" chains and attached cord & plug
GRAH-36	AH36120ICCS	495		
GRAH-48	AH48120ICCS	545		
GRAH-60	AH60120ICCS	604		

* Not available for Canada

ALUMINUM DUAL INFRARED STRIP HEATERS

Model	Item Number	Voltage/Phase		Description
		120/1		
High Watt Dual				
GRAH-24D	GRAH24D120V	\$ 857		3" spacer and conduit
GRAH-36D	GRAH36D120V	1036		
GRAH-48D	GRAH48D120V	1215		
High Watt Dual with Lights				
GRAHL-24D	AHL24D120V	\$ 941		3" spacer with lights and conduit
GRAHL-36D	AHL36D120V	1159		
GRAHL-48D	AHL48D120V	1386		

FRY STATIONS

Model	Item Number	Voltage/Phase		Description
		120/1		
Ultra-Glo®				
UGFF	GRFFC18115T	\$ 844		With built-in toggle switch
UGFFL	GRFFCL18120T	1041		With built-in toggle switch
UGFFB	FFBC18120T	1271		With built-in toggle switch
UGFFBL	FFBCL18120T	1473		With built-in toggle switch

FRY STATIONS

Model	Item Number	Voltage/Phase 120/1	Description
Glo-Ray®			
GRFF	GRFF115T	\$ 674	With built-in toggle switch
GRFFL	GRFFL120T	866	With built-in toggle switch
GRFFB	GRFFB115T	1108	14" clearance
GRFHS-21	GRFHS21	3776	21" wide with thermostatic control, long trivet and divider

PORTABLES

Model	Item Number	Voltage/Phase 120/1	Description
Lamp Warmer (Gray Granite)			
LW-2	LW-2	\$816	Two heat lamps
Glo-Ray® Heated Shelves			
GRS-24-I	GRS24120-1	\$1071	Standard Depth - 19½"
GRS-30-I	GRS30120-1	1154	Standard Depth - 19½"
GRS-36-I	GRS36120-1	1235	Standard Depth - 19½"
GRS-48-I	GRS48120-1	1454	Standard Depth - 19½"
Heated Glass Shelf Modular			
HGSM-1P	HGSM.00004	\$961	15¾"W x 23½"D x 3 ¾"H
Glo-Ray® Buffet Warmers			
GRBW-24	GRBW24120V	\$2135	Thermostatically-controlled base heat, infrared top heat
GRBW-36	GRBW36120V	2591	Thermostatically-controlled base heat, infrared top heat
GRBW-48	GRBW48120V	3047	Thermostatically-controlled base heat, infrared top heat

BUILT-INS

Model	Item Number	Voltage/Phase 120/1	Description
Glo-Ray® Built-In Heated Shelves with Recessed Top			
GRSB-24-I	GRSB24120V	\$1794	Standard depth - 21"
GRSB-30-I	GRSB30120V	1912	Standard depth - 21"
GRSB-36-I	GRSB36120V	2033	Standard depth - 21"
GRSB-48-I	GRSB48120V	2249	Standard depth - 21"
Glo-Ray® Built-In Heated Shelves with Flush Top			
GRSBF-24-I	GRSBF24120V	\$1794	Standard depth - 21"
GRSBF-30-I	GRSBF30120V	1912	Standard depth - 21"
GRSBF-36-I	GRSBF36120V	2033	Standard depth - 21"
GRSBF-48-I	GRSBF48120V	2249	Standard depth - 21"

DRAWER WARMERS

Model	Item Number	Voltage/Phase 120/1	Description
Freestanding			
HDW-1	HDW1-120V	\$2870	Single drawer with 4" legs
HDW-2	HDW2-120V	4872	Two drawers with 4" legs
HDW-3	HDW3-120V	6879	Three drawers with 4" legs
Built-In			
HDW-2B	HDW2B-120V	\$4667	Two drawers, built-in

MERCHANDISERS

Model	Item Number	Voltage/Phase 120/1	Description
Glo-Ray® Merchandising Slant Warmers			
GRSDS-24	GRSDS24120-1	\$3677	Single tier slant
GRSDS-30D	GRSDS30D120	6099	Dual tier slant
GRSDS-36D	GRSDSD36120-1	6497	Dual tier slant
Glo-Ray® Designer Heated Display Cases			
GRCD-3PD	GRCD3PD120V	\$8028	3-pan <i>Designer</i> dual shelf
GRCDH-3PD	GRCDH3PD120V	8778	3-pan <i>Designer</i> dual shelf with humidity

**HOLDING AND DISPLAY CABINETS***

Model	Item Number	Voltage/Phase 120/1	Description
Plate Warmers			
PWC-12	PWC.12BLK515	\$2630	Countertop, <i>Designer</i> Black
PWC-12	PWC.12SS515	2232	Countertop, Stainless Steel
PWB-12	PWB.12BLK515	2416	Countertop, <i>Designer</i> Black
PWB-12	PWB.12SS515	2018	Countertop, Stainless Steel
Flav-R-Fresh® Humidified Display Cabinets			
FDWD-1	FDWD1	\$4054	1 Door, 4-tier circle revolving rack
FDWD-1X	FDWD1X	3930	1 Door, 4-shelf multi-purpose rack
FDWD-2	FDWD2	4181	2 Door, 4-tier circle revolving rack
Flav-R-Savor® Humidified Holding & Display Cabinets			
FSD-1	FSD1-1	\$5078	3-tier circle revolving rack
FSD-1X	FSD1X-1	4926	3-tier pan multi-purpose rack
FSDT-1	FSDT1-1	5163	Tall, 4-tier circle revolving rack
FSDT-1X	FSDT1X-1	4961	Tall, 4-tier pan multi-purpose rack
Flav-R-Savor® Humidified Holding Cabinets			
FSHC-7-1	FSHC7-1	\$ 7154	Rack slides, 4" casters
FSHC-12W1	FSHC-12W1	11390	Single Lexan® door
FSHC-17W1	FSHC-17W1	11572	Single Lexan® door
FSHC-17W1D	FSHC-17W1D	12450	Single opening with 2 Dutch doors

TOASTERS

Model	Item Number	Voltage/Phase 120/1	Voltage/Phase 208/1	Voltage/Phase 240/1	Description
Pop-Up Toasters					
TPT-120	TPT3.120	\$496			
TPT-120	TPT120.BB515	623			Pop-Up in Bold Black
TPT-120	TPT120.RR515	623			Pop-Up in Radiant Red
TPT-208	TPT3.208		\$895		Pop-Up toaster
TPT-240	TPT3.240			\$895	Pop-Up toaster
Toast-Qwik®					
TQ3-10	TQ310120BK515	\$1458			Horizontal conveyor toaster
TQ3-10	TQ310120BK520	1458			Horizontal conveyor toaster
TQ3-10	TQ310208BK615		\$1458		Horizontal conveyor toaster
TQ3-10	TQ310240BK615			\$1458	Horizontal conveyor toaster
TQ3-400	TQ3400120B515	\$2802			Programmable conveyor toaster, <i>Designer</i> Black
TQ3-400	TQ3400120S515	3051			Programmable conveyor toaster, Stainless Steel
TQ3-500	TQ3500208B615		\$2986		Programmable conveyor toaster, <i>Designer</i> Black
TQ3-500	TQ3500208S615		3235		Programmable conveyor toaster, Stainless Steel
TQ3-500	TQ3500240B615			\$2986	Programmable conveyor toaster, <i>Designer</i> Black
TQ3-500	TQ3500240S615			3235	Programmable conveyor toaster, Stainless Steel
TQ3-500H	TQ3500H208B615		\$2986		Programmable conveyor toaster, <i>Designer</i> Black
TQ3-500H	TQ3500H208S615		3235		Programmable conveyor toaster, Stainless Steel
TQ3-500H	TQ3500H240B615			\$2986	Programmable conveyor toaster, <i>Designer</i> Black
TQ3-500H	TQ3500H240S615			3235	Programmable conveyor toaster, Stainless Steel
TQ3-900	TQ3900208B620		\$3190		Programmable conveyor toaster, <i>Designer</i> Black
TQ3-900	TQ3900208S620		3439		Programmable conveyor toaster, Stainless Steel
TQ3-900	TQ3900240B620			\$3190	Programmable conveyor toaster, <i>Designer</i> Black
TQ3-900	TQ3900240S620			3439	Programmable conveyor toaster, Stainless Steel
TQ3-900H	TQ3900H208B620		\$3190		Programmable conveyor toaster, <i>Designer</i> Black
TQ3-900H	TQ3900H208S620		3439		Programmable conveyor toaster, Stainless Steel
TQ3-900H	TQ3900H240B620			\$3190	Programmable conveyor toaster, <i>Designer</i> Black
TQ3-900H	TQ3900H240S620			3439	Programmable conveyor toaster, Stainless Steel
TQ3-2000	TQ32000208B630		\$4019		Programmable conveyor toaster, <i>Designer</i> Black
TQ3-2000	TQ32000208S630		4268		Programmable conveyor toaster, Stainless Steel
TQ3-2000	TQ32000240B630			\$4019	Programmable conveyor toaster, <i>Designer</i> Black
TQ3-2000	TQ32000240S630			4268	Programmable conveyor toaster, Stainless Steel
TQ3-2000H	TQ32000H208B630		\$4019		Programmable conveyor toaster, <i>Designer</i> Black
TQ3-2000H	TQ32000H208S630		4268		Programmable conveyor toaster, Stainless Steel
TQ3-2000H	TQ32000H240B630			\$4019	Programmable conveyor toaster, <i>Designer</i> Black
TQ3-2000H	TQ32000H240S630			4268	Programmable conveyor toaster, Stainless Steel
Toast King®					
TK-72	TK72208		\$5014		Vertical conveyor toaster
TK-100	TK100208 - TK100230		5364	\$5364	Vertical conveyor toaster

INDUCTION

Model	Item Number	Voltage/Phase 120/1	Voltage/Phase 208-240	Description
Boxer® Countertop Ranges				
IRNG-BXC1-14	IRNGBXC114515	\$1232		1440W, 1 hob
IRNG-BXC1-18	IRNGBXC118515	1232		1800W, 1 hob
Rapide Cuisine® Countertop Heavy-Duty Ranges				
IRNG-HC1-14	IRNGHC114SB515	\$1552		1440W, heavy-duty, 1 hob
IRNG-HC1-18	IRNGHC118SB515	1552		1800W, heavy-duty, 1 hob
Rapide Cuisine® Countertop Ranges				
IRNG-PC1-14	IRNGPC114SB515	\$1426		1400W, Stainless Steel/Bold Black, programmable, 1 hob
IRNG-PC1-18	IRNGPC118SB515	1426		1800W, Stainless Steel/Bold Black, programmable, 1 hob
IRNG-PC1-18	IRNGPC118BB515	1550		1800W, Bold Black/Bold Black, programmable, 1 hob
Rapide Cuisine® Drop-In Ranges				
IRNG-PB1-14	IRNGPB114515	\$1552		1400W, programmable, 1 hob
IRNG-PB1-18	IRNGPB118515	1552		1800W, programmable, 1 hob
IRNG-PB1-18	IRNGPB118520	1552		1800W, programmable, 1 hob
Rapide Cuisine® Countertop High-Powered/Heavy-Duty Range				
IRNG-PC1-36	IRNGPC136SB620		\$2266	3120-3600 watts, programmable, 1 hob
Rapide Cuisine® Drop-In High-Powered/Heavy-Duty Range				
IRNG-PB1-36	IRNGPB136SB620		\$2390	3120-3600W, programmable, 1 hob
Rapide Cuisine® Drop-In High-Powered/Heavy-Duty Dual Ranges				
IRNG-PB2-29	IRNGPB229630		\$4159	Built-In, Side to Side, Dual Range, 2496-2880W per coil
IRNG-PB2-36	IRNGPB236650		4362	Built-In, Side to Side, Dual Range, 3120-3600W per coil
IRNG-PB2-24-IA	IRNGPB224IA620		4368	Built-In, Side to Side, Dual Range, 1803-2400W per coil
IRNG-PB2-36-IA	IRNGPB236IA630		4582	Built-In, Side to Side, Dual Range, 3060-1800W per coil
Rapide Cuisine® Countertop High-Powered/Heavy-Duty Dual Ranges				
IRNG-PC2F-29	IRNGPC2F29630		\$4434	Front to Back, Dual Range, 2496-3600W per coil
IRNG-PC2F-36	IRNGPC2F36650		4925	Front to Back, Dual Range, 3120-3600W per coil
IRNG-PC2F-24-IA	IRNGPC2F24IA620		4657	Front to Back, Dual Range, 1803/2400W per coil
IRNG-PC2F-36-IA	IRNGPC2F36IA630		5171	Front to Back, Dual Range, 3060/1800W per coil
IRNG-PC2S-29	IRNGPC2S29630		4434	Side to Side, Dual Range, 2496-3600W per coil
IRNG-PC2S-36	IRNGPC2S36650		4925	Side to Side, Dual Range, 3120-3600W per coil
IRNG-PC2S-24-IA	IRNGPC2S24IA620		4657	Side to Side, Dual Range, 1803-2400W per coil
IRNG-PC2S-36-IA	IRNGPC2S36IA630		5171	Side to Side, Dual Range, 3060-1800W per coil
Palletti® Countertop Warmers				
IWRM-C1-1317-06	IWRMC113176B515	\$1109		600W, Countertop Warmer, 1 hob
IWRM-CD1-03	IWRMCD13B515	1231		Daisy Chain Countertop Warmer
Palletti® Drop-In Warmers				
IWRM-B1-1313-06	IWRMB113136B515	\$1109		600W, Drop-In Warmer, 1 hob, Black Glass-Ceramic top
IWRM-B1-1313-06	IWRMB113136W515	1109		600W, Drop-In Warmer, 1 hob, White Glass-Ceramic top
Maskerade™ Undercounter Warmer				
IWRM-UT-06	IWRMBUT6515	\$1788		600W, slip-resistant trivet

LIGHT COOKING EQUIPMENT

Model	Item Number	Voltage/Phase 120/1	Voltage/Phase 208-240/1	Natural Gas	Description
Electric Crepe Maker - Single Head, Light Duty					
KCME-1RND	KCME.1RND515	\$2211			Single, round
Electric Crepe Makers - Single Head, Heavy Duty					
KCME-1RND	KCME.1RND620		\$3063		Single, round
KCME-1RCT	KCME.1RCT620		3552		Single, rectangular
Electric Crepe Maker - Double Head, Heavy Duty					
KCME-2RCT	KCME.2RCT2620		\$6045		Dual, rectangular, (2) NEMA 6-20P
Gas Crepe Makers - Single Head					
KCMG-1RND	KCMG.1RND22			\$2604	Single, 15.75" diameter, round frame
KCMG-1RCT	KCMG.1RCT22			2647	Single, 15.75" diameter, rectangular frame
Gas Crepe Maker - Double Head					
KCMG-2RCT	KCMG.2RCT41			\$6167	Dual, 1575" diameter, rectangular frame
Electric Waffle Makers/Warmers - 90° Hinge, Single Head					
KWM09-1BR46	KWM09.1BR46515	\$3336			Brussels 4 x 6
KWM09-1BR46	KWM09.1BR46620		\$3336		Brussels 4 x 6
KWM09-1LG47	KWM09.1LG47515	3336			Liège 4 x 7
Electric Waffle Makers - 180° Hinge, Single Head					
KWM18-1BR35	KWM18.1BR35515	\$3881			Brussels 3 x 5
KWM18-1BR46	KWM18.1BR46515	3881			Brussels 4 x 6
KWM18-1BR46	KWM18.1BR46620		\$3881		Brussels 4 x 6
KWM18-1LG47	KWM18.1LG47515	3881			Liège 4 x 7
KWM18-1LG47	KWM18.1LG47620		3881		Liège 4 x 7

**LIGHT COOKING EQUIPMENT**

Model	Item Number	Voltage/Phase 120/1	Voltage/Phase 208-240/1	Natural Gas	Description
Electric Bubble Waffle Maker - 180° Hinge, Single Head					
KWM18-1BU	KWM18.1BU515	\$3927			Bubble
Electric Waffle Makers - 180° Hinge, Dual Head					
KWM18-2LG47	KWM18.2LG47620		\$7234		Liège 4 x 7
KWM18-2BR46	KWM18.2BR46620		7234		Brussels 4 X 6
Electric Waffle Maker/Warmer - 90° Hinge, Single Head Round					
KWM09-1R07	KWM09.1R07515	\$3921			Round
Electric Waffle Maker -180° Hinge, Single Head Round					
KWM18-1R07	KWM18.1R07515	\$4587			Round
Electric Waffle Makers - 180° Hinge, Dual Head Swivel					
KWMSL-2LG413	KWMSL.2LG413620		\$9047		Swivel, Liège 4 x 13
KWMSL-4BR46	KWMSL.4BR46620		9152		Swivel, Brussel 4 x 6
Churro Makers					
KWM18-16CH	KWM18.16CH515	\$3486			180°, Single
KWM18-32CH	KWM18.32CH620		\$6539		180°, Dual
Sauce Warmers					
KSW-1	KSW.1515	\$1592			One bottle well
KSW-2	KSW.2515	2494			Two bottle well
KSW-3	KSW.3515	3612			Three bottle well
Electric Griddle					
KGRDE-2513	KGRDE.2513620		\$3355		Electric Griddle
Gas Griddle					
KGRDG-2513	KGRDG.251314		\$3355		Gas Griddle, 13648 BTU
Multi Contact Grills - Top Grooved, Bottom Grooved (Plates)					
MCG10G	MCG10G.515P	\$2066			10" cooking width, top grooved/bottom grooved
MCG10G	MCG10G.520P.01	2066			10" cooking width, top grooved/bottom grooved
MCG14G	MCG14G.515P	2331			14" cooking width, top grooved/bottom grooved
MCG14G	MCG14G.615P.01		\$2331		14" cooking width, top grooved/bottom grooved
MCG20G	MCG20G.620P.01		3617		20" cooking width, top grooved/bottom grooved
Multi Contact Grills - Top Smooth, Bottom Smooth (Plates)					
MCG14S	MCG14S.515P	\$2331			14" cooking width, top smooth/bottom smooth
MCG14S	MCG14S.520P	2331			14" cooking width, top smooth/bottom smooth
MCG14S	MCG14S.615P		\$2331		14" cooking width, top smooth/bottom smooth
Multi Contact Grills - Top Grooved, Bottom Smooth (Plates)					
MCG20GS	MCG20GS.620P		\$3617		20" cooking width, top grooved/bottom smooth
Snack System					
SNACK-1	SNACK1.515	\$1710			Single head
SNACK-2	SNACK2.515	2770			Dual head
SNACK-2	SNACK2.520	2770			Dual head
Round Waffle Makers					
RWM-1	RWM1.515	\$1008			Single head, round plate, standard style
RWM-1B	RWM1B.515	1008			Single head, round plate, Belgian style
RWM-2	RWM2.515	1755			Double head, round plate, standard style
RWM-2	RWM2.520	1755			Double head, round plate, standard style
RWM-2B	RWM2B.515	1755			Double head, round plate, Belgian style
RWM-2B	RWM2B.520	1755			Double head, round plate, Belgian style
Flip Waffle Maker					
FWM-18	FWM1B.515	\$2201			Round

WATER HEATING EQUIPMENT

Model	Item Number	Voltage/Phase 120/1	Voltage/Phase 208/1	Voltage/Phase 208/3	Voltage/Phase 240/1	Voltage/Phase 240/3	Voltage/Phase 480/3
Sink Heaters (Electric)							
3CS-6*	3CS620813		\$2961	\$2961			
3CS-6*	3CS624013				\$2961	\$2961	
3CS-9*	3CS920813		3066	3066			
3CS-9*	3CS924013				3066	3066	
3CS-9*	3CS948013						\$3178
Food Rethermalizers (Electric)							
FR-4*	FR42081W/O		\$2676				
FR-6*	FR620813W/O		2951	2951			
FR-9*	FR920813W/O		3026	3026			
FR-9*	FR924013W/O				3026	3026	

WATER HEATING EQUIPMENT

Model	Item Number	Voltage/Phase 120/1	Voltage/Phase 208/1	Voltage/Phase 208/3	Voltage/Phase 240/1	Voltage/Phase 240/3	Voltage/Phase 480/3
Powermite® (Natural Gas)							
(Quick-Ship Models are manufactured with orifice kits up to 2000 ft elevation)							
PMG-100	PMG100120NAT	\$17041					
PMG-200	PMG200120NAT	20216					
Compact (Electric) with Legs							
C-4	C42081LE		\$3831				
C-5	C52081LE		3881				
C-6*	C620813LE		3951	\$3951			
C-6*	C624013LE				\$3951	\$3951	
C-7*	C720813LE		4006	4006			
C-7*	C724013LE				4006	4006	
C-9*	C920813LE		4046	4046			
C-9*	C924013LE				4046	4046	
C-12	C122081LE		4281				
C-12	C122083LE			4281			
C-12	C122401LE				4281		
C-12	C122403LE					4281	
C-12	C124803LE						\$4281
C-15	C152081LE		4366				
C-15	C152083LE			4366			
C-15	C152401LE				4366		
C-15	C152403LE					4366	
C-15	C154803LE						4366
C-17	C172083LE			4396			
C-24	C242083LE			5896			
C-27	C272083LE			5986			
C-27	C272403LE					5986	
C-27	C274803LE						5986
C-30	C302083LE			6041			
C-30	C302403LE					6041	
C-30	C304803LE						6041
C-36	C362083LE			6316			
C-36	C362403LE					6316	
C-36	C364803LE						6236
C-45	C452083LE			7156			
C-45	C452403LE					7156	
C-45	C454803LE						7066
C-54	C542083LE			7356			
C-54	C542403LE					7356	
C-54	C544803LE						7261
C-57	C572083LE			7501			
C-57	C572403LE					7501	
C-57	C574803LE						7401
Imperial (Electric) with Legs							
S-12	S122083L			\$5986			
S-15	S152083L			6041			
S-36	S362083L			7651			
S-36	S362403L					\$7651	
S-36	S364803L						\$7616
S-45	S452083L			8126			
S-45	S454803L						8076
S-54	S542083L			8146			
S-54	S542403L					8146	
S-54	S544803L						8091

* Open delta, single or three phase.

• Without low-water cut-off.



General Information

Terms of Sale: EX Works
Sturgeon Bay, WI 54235 U.S.A.

Corporate Office: Milwaukee, Wisconsin 53215

Manufacturing: Sturgeon Bay, Wisconsin 54235

Price Policy: Prices supercede all previously published prices and are subject to change without notice. Prices and discounts apply to accessories at time of initial equipment order only.

Remittance: Forward payment to:
Hatco Corporation
Box 68-4035
Chicago, IL 60695-4035

Delivery: Consult Hatco Equipment Sales Department for delivery times and estimated shipping charges.

Freight Classification: See Hatco website for more details:
www.hatcocorp.com
under the RESOURCES tab in the upper right-hand corner, click on EQUIPMENT SHIPPING INFO

Business Hours:
Equipment Sales & Customer Service
7:00 a.m. to 5:00 p.m. Central Time
General Office
8:00 a.m. to 5:00 p.m. Central Time
(Summer Hours: June to September:
8:00 a.m. to 5:00 p.m. C.T. Monday thru Thursday
8:00 a.m. to 2:30 p.m. C.T. Friday)

Sales catalogs, brochures, specification sheets and other literature available at www.hatcocorp.com.

ALL HATCO PRODUCTS SHIPPED WITH INSTALLATION AND OPERATING INSTRUCTIONS. CONSULT LOCAL CODES BEFORE INSTALLING EQUIPMENT.

E-mail inquiries and requests to: support@hatcocorp.com

E-mail orders to: equipsales@hatcocorp.com

Telephone: Equipment Orders & Inquiries: (800) 446-8433
General Office: (800) 558-0607, (414) 671-6350

www.hatcocorp.com

Conversions

Watts ÷ Volts = Amps (Single Phase only)

Inches x 25.4 = Millimeters

Pounds ÷ 2.2 = Kilograms or Pounds x .4536 = Kilograms

(°Fahrenheit - 32) x .56 = °Celsius

Gallons ÷ .264 = Liters or Gallons x 3.7853 = Liters

Water Quality Requirements

Water supply in excess of 3.0 grains of hardness per gallon (GPG) must be treated and softened before being used. Water containing over 3.0 GPG will decrease the efficiency and reduce the operating life of the unit.

NOTE: Product failure caused by liming or sediment buildup is not covered under warranty.

NOTE: See page 234 for Picture of Blended Phosphate Water Treatment System.

Hatco products are manufactured for commercial use only and meet one or more of these agency certifications.



See product specification sheet for the appropriate approvals.

120 Volt Models

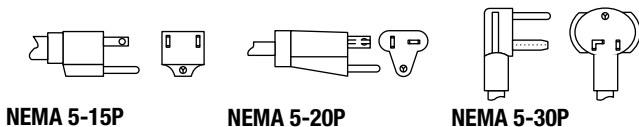

208 or 240 Volt Models

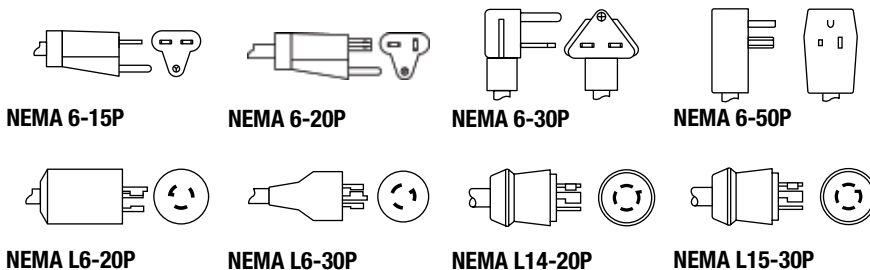

Limited Warranty

For the full information pertaining to the Hatco warranty protection for your equipment, go to our website at:

www.hatcocorp.com

Step 1: make sure you are on your region

Step 2: in the **Support** drop-down at the top of the page, select **Warranty**

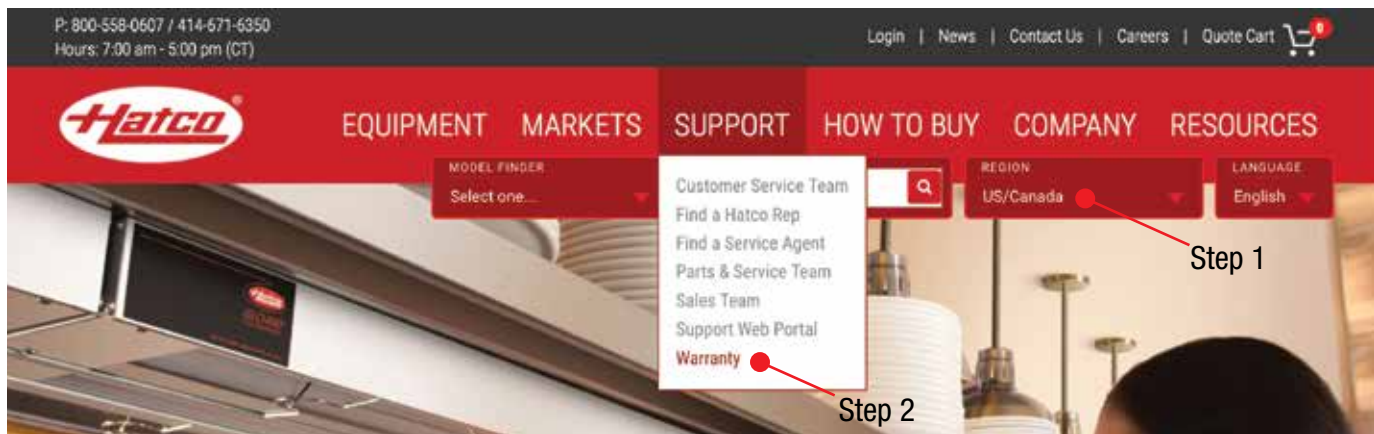

Ordering Procedures

CUSTOMER NOTE –

To ensure prompt and accurate processing of your order, please provide the following information:

ALL PRODUCTS –

1. Model number, voltage and phase.
2. Specify options and accessories as required. Options are not retrofittable.
3. Consult factory when ordering equipment for special applications.
4. Phone orders are acceptable, but a confirming written order is required. E-mail orders do not require confirmation.

Returns

New and unused equipment can only be returned for credit review with prior approval of the Hatco Corporation. Contact Customer Service or Sales & Marketing for a Material Return Authorization (MRA). Returns must be shipped PREPAID and are subject to inspection. All goods returned for customer convenience are subject to a restocking charge of 25%. In the event of an error by Hatco, an MRA will be issued for full credit. Custom-built equipment and equipment older than 120 days (from date of shipment) does not qualify for return credit. Electronic Controls and Decorative Lamps (all models) are considered custom built and are non-returnable.

Return Equipment to: Hatco Corporation
208 East Deck Street
Sturgeon Bay, WI 54235-1936 U.S.A.

Damaged Freight Policy

In accordance with the National Motor Freight Traffic Association, it is the consignee's responsibility to inspect and ensure the shipment has not sustained any damage during transportation to destination. All freight should be inspected during the receiving process for possible damage. Should there be a question about the condition of the equipment, it is better to refuse the shipment. If damage is found after delivery, it is the consignee's (receiver) responsibility to notify the carrier within **(5) days** of the delivery.

Whether the shipment was routed by a Hatco preferred carrier or customer selected third party carrier, Hatco will assist its customers in achieving a solution. If it is found that any part of the shipment has sustained damage during transportation, Hatco Corporation must be contacted to file a damage report

For assistance, contact Hatco Customer Service at (800)558-0607 and have the information listed below available.

1. Copy of Bill of Lading and Pro numbers
2. Delivery date and date damage was discovered
3. Contact name, phone number and email address
4. Type of unit damaged including model and serial number
5. Extent of damage
6. Pictures of damage as well as packaging
7. Original shipping papers and packaging

Accessories Charges

When shipping LTL using a Hatco preferred carrier, additional fees known as accessorial charges may apply and will be added to order. Residential Delivery Fee, Construction Site Delivery Fee, Government Site Delivery Fee, limited access fee are all fees added automatically by the carrier based on where the order is shipping. The fee varies depending on the service, delivery location and carrier.

Liftgate is charged by the carrier if the consignee does not have a loading dock or a forklift onsite to unload the freight from the truck. Optional services available for an additional fee include Inside Delivery, Call before Delivery and Delivery by Appointment. Hatco must be made aware of any special services needed at the time of order or prior to shipment so the fee can be added to the original invoice, otherwise the fee will be post billed and a second invoice will be received for this charge.

**Fee amount varies by carrier.



Product Index

ORDER PICKUP STATIONS & FOOD LOCKERS	2-9
WELLS	10-52
DECORATIVE LAMPS & DISPLAY LIGHTS	53-63
STRIP HEATERS	64-97
FRY STATIONS	98-103
CARVING STATIONS	104-106
PORTABLES	107-120
BUILT-INS	121-141

DRAWER WARMERS	142-147
MERCHANDISERS	148-170
HOLDING & DISPLAY CABINETS	171-190
TOASTERS	191-197
INDUCTION EQUIPMENT	198-209
LIGHT COOKING EQUIPMENT	210-221
WATER HEATING/SPECIALTY EQUIPMENT	222-239

3CS	224
3CS2	225
AWD	223
C	230-231
CDW	146
CHW	17
CLED	63
CSBF, CSBFR, CSBFX	128-129
CSSB, CSSBR, CSSBX	125
CSSBF, CSSBFR, CSSBFX	126-127
CSU, CSUR, CSUX	130-131
CWB, CWB-S	23-25, 29
CWBR, CWBX, CWBR-S, CWBX-S	26-29
DCS	105
DHWBI, DHWBI-S	11-14
DL, DLL, DLH	54-60
F2G, F2GB	4-5
F2GP, F2GBP	6-7
FDWD-1-MN	183
FDWD	173, 176-177
FR	226
FR2	227
FS2HAC	190
FS3HAC	149-150
FSCD, FSCDH	168
FSD, FSDT	174-177
FSHAC, FSHACH	190
FSHC-5W, -7W	185
FSHC-6W	186
FSHC-7	187
FSHC-12W, -17W	188-189
FST-1-MN	183
FTB, FTB-S	30-31
FTBR, FTBR-S, FTBX, FTBX-S	32-33
FWM	218
GR2A, GR2AH	86, 88
GR2A-xxD, GR2AH-xxD	89-90
GR2AL, GR2AHL	87-88
GR2AL-xxD, GR2AHL-xxD	89-90
GR2BW	119-120
GR2S	114
GR2SDH, GR2SDS	157-158
GR3SDH, GR3SDS	162-163
GR3SDS-xxDCT, GR3SDS-xxTCT	164
GR5A, GR5AH	67, 69
GR5AL, GR5AHL	68-69
GR, GRH	71-72
GR-B	99
GRA, GRAH	70, 72
GRA-xxD, GRAH-xxD	73, 75

GRAL, GRAHL	71-72
GRAL-xxD, GRAHL-xxD	74-75
GRAIH, GRAIHL	83, 85
GRAIH-xxD, GRAIHL-xxD	84-85
GRAM, GRAML	76-77
GRAM-xxD	78, 80
GRAML-xxD	79-80
GRBW	119-120
GRCD, GRCDH	166-167
GRCMW	165
GRCSCCL, GRCSCCLH	106
GRFF, GRFFL, GRFFB, GRFFBL	99-100
GRFHS	101-102
GRFS	101-102
GRHD, GRHDH	169-170
GRHW	118
GRN, GRNH	81
GRNM	82
GRPWS	152-153
GRS2G	8
GRS	112-114
GRSB	139-140
GRSBF	141
GRSDH, GRSDS	155-156
GRSDS/H	154
GRSR	109
GRSS	115
GRSSB	137
GRSSR, GRSSRxx-DL77516	110-111
HBG	116
HBGB	138
HCSBF, HCSBFR, HCSBFX	135-136
HCSSB, HCSSBR, HCSSBX	132
HCSSBF, HCSSBFR, HCSSBFX	133-134
HCWBI, HCWBIR, HCWBIX	18-19
HDW	144-145
HDWTC	143
HDW-xr2	144-145
HGSM	117
HL	62
HL5	61
HRDW	147
HSBF-GL, -HC, -SS	122-124
HW	17
HWB, HWBL	43-45, 51-52
HWB-xxQT, HWBI-xxQT	46-47, 51-52
HWBI, HWBLI	34-36, 40
HWBI43	37, 40
HWBI-S	38-40
HWBRN, HWBRN (UR)	48-49, 51-52

HWBRT, HWBRT (UR)	48-49, 51-52
HWBRN-xxQT (UR)	50, 51-52
HWBRT-xxQT (UR)	50, 51-52
HXMH, HXMS	159, 161
HZMH, HZMS	160-161
IHDCH	178-179
IRNG-BXC1	199
IRNG-HC1, -PC1, -PB1	200-204
IRNG-PC2F, -PC2S, -PB2	205-206
IWRM-C1, -CD1, -B1	207-208
IWRM-UT	209
IWB, IWB-S	20-22
ITQ	192
KCME	211
KCMG	212
KGRDE	216
KGRDG	216
KSW	215
KWM09, KWM18	213-214
KWMSL	213
LFST	181
LW	108
MC	229
MCG	217
MDW	182
MPP	3
MPWS	103
PDH	151
PFST	184
PMG	228
PSH	151
PWB, PWC	172
RHW	15
RMB	97
RMB2	96
RWM	220
S	232-233
SAL	221
SNACK	219
SW2	16
TK	197
TPT	193
TQ	195-196
TQ3	194
UGA, UGAH	91, 93
UGA-xxD, UGAH-xxD	92-93
UGAL, UGAHL	91, 93
UGAL-xxD, UGAHL-xxD	92-93
UGFF, UGFFL, UGFFB, UGFFBL	99-100
WFST	180



Paint Chip and Stone Sample Colors

DESIGNER COLORS



Warm Red



Black



Gray
Granite



White
Granite



Navy
Blue



Hunter
Green



Antique
Copper

GLOSS FINISHES



Smooth
White



Gleaming
Gold



Glossy
Gray



Bold
Black



Radiant
Red



Brilliant
Blue



Clear Brushed
Metal Finish

PLATED FINISHES



Bright
Brass



Bright
Nickel



Bright
Copper



Antique
Nickel



Antique
Brass



Antique
Bronze

SIMULATED STONE COLORS*



Gray
Granite



Bermuda
Sand



Night Sky

*Colors are a representation and may not exactly match our colors.
Consult factory for possible color matching options on these colors.
Non-standard colors are non-returnable.*

To order a Hatco Paint Chip & Stone Sample Colors Sheet, visit www.hatcocorp.com / *Order Literature / Sales Literature / Sell Sheets.*

* Simulated Stone is Swanstone®



People who serve, products that solve.®

Hatco Corporation

P.O. Box 340500 • Milwaukee, WI 53234-0500

800-558-0607 • 414-671-6350

support@hatcocorp.com • www.hatcocorp.com

Domestic Price List • July 1, 2022